

Megohmmeter Models 6528 and 6529

■ True Megohmmeter®

User Manual
ENGLISH



Measure up

www.aemc.com

AEMC[®]
INSTRUMENTS
CHAUVIN ARNOUX GROUP

Copyright © Chauvin Arnoux®, Inc. d.b.a. AEMC® Instruments. All rights reserved.

No part of this documentation may be reproduced in any form or by any means (including electronic storage and retrieval or translation into any other language) without prior agreement and written consent from Chauvin Arnoux®, Inc., as governed by United States and International copyright laws.

Chauvin Arnoux®, Inc. d.b.a. AEMC® Instruments
15 Faraday Drive • Dover, NH 03820 USA
Tel: (800) 945-2362 or (603) 749-6434 • Fax: (603) 742-2346

This documentation is provided “as is,” without warranty of any kind, express, implied, or otherwise. Chauvin Arnoux®, Inc. has made every reasonable effort to ensure that this documentation is accurate; but does not warrant the accuracy or completeness of the text, graphics, or other information contained in this documentation. Chauvin Arnoux®, Inc. shall not be liable for any damages, special, indirect, incidental, or inconsequential; including (but not limited to) physical, emotional or monetary damages due to lost revenues or lost profits that may result from the use of this documentation, whether or not the user of the documentation has been advised of the possibility of such damages.

Chauvin Arnoux®, Inc, AEMC®, and DataView® are registered trademarks of AEMC® Instruments.

Statement of Compliance

Chauvin Arnoux®, Inc. d.b.a. AEMC® Instruments certifies that this instrument has been calibrated using standards and instruments traceable to international standards.

We guarantee that at the time of shipping your instrument has met its published specifications.

An NIST traceable certificate may be requested at the time of purchase, or obtained by returning the instrument to our repair and calibration facility, for a nominal charge.

The recommended calibration interval for this instrument is 12 months and begins on the date of receipt by the customer. For recalibration, please use our calibration services. Refer to our repair and calibration section at www.aemc.com.

Serial #: _____

Catalog #: 2126.54 / 2126.55

Model #: 6528 / 6529

Please fill in the appropriate date as indicated:

Date Received: _____

Date Calibration Due: _____

















Chauvin Arnoux®, Inc.
d.b.a AEMC® Instruments
www.aemc.com

MEASUREMENT CATEGORIES

Thank you for purchasing the True Megohmmeter® Model 6528 or 6529. For best results with your instrument:

- **Read** this user manual carefully
- **Respect** precautions for use

	AC - Alternating current		DC - Direct Current
	AC or DC		Double insulated
	Shock Hazard		Fuse
	Battery		Instructions that must be read and understood
	Instrument follows recycling directives		Comply with US directives
	Sorting for the recycling of electric and electronic waste		Earth Ground
	Danger Hazard		Voltage on the instrument should not exceed 770V _{RMS}

Definition of Measurement Categories (CAT)

- **CAT IV:** Test and measurement circuits connected to the source of the building's low-voltage network installation.

Example: Measurement on equipment installed upstream of the main fuse or building installation cut-off switch.

- **CAT III:** Test and measurement circuits connected to parts of the building's low voltage network installation.

Example: Measurement on distribution switchboards (including secondary meters), the circuit breakers, cabling including cables, busbars, junction boxes, circuit breakers, power outlets in the fixed installation and industrial instruments and other equipment such as motors permanently connected to the fixed installation.

- **CAT II:** Test and measurement circuits directly connected to points of use (power outlets and other similar points) on the low voltage network.

Example: Measurement on circuits in network for household appliances, portable tools and other similar instruments.

PRECAUTIONS FOR USE

Failure to comply with safety instructions can create a risk of electric shock, fire, explosion and destruction of the instrument or the installations. If the instrument is used other than as specified in this User Manual, the protection provided by the instrument may be impaired.

- The operator and/or the responsible authority must carefully read and clearly understand the various precautions to be taken in use.
- Before using the instrument, make sure it functions properly by measuring a known voltage and a known insulation resistor, and check continuity by short circuiting both test leads.
- Do not use the instrument in an explosive atmosphere or in the presence of inflammable gas or smoke.
- Do not use the instrument on networks with a rated voltage or category higher than those listed in this manual.
- Respect the maximum rated voltages and currents between terminals and in relation to the earth.
- Do not use the instrument if it seems damaged, incomplete, or incorrectly closed.
- Before each use, check the condition of the cable insulation, the instrument, and its accessories. All elements on which the insulation is damaged (even partially) must be put out of service for repair or disposed as waste.
- Use cables and accessories for voltage according to IEC 61010-031 and measurement categories at least equal to those of the instrument. If not, an accessory of a lower category reduces the category of the combined megohmmeter plus the accessory to that of the accessory.
- Respect the environmental conditions of use.
- Strictly comply with the fuse specifications. Disconnect all cables before opening the fuse access cover.
- Do not modify the instrument, and, do not replace components using equivalent parts. Repairs and adjustments must be performed by qualified, approved personnel.
- Replace the battery as soon as the  symbol appears on the display. Disconnect all cables before opening the battery access cover.
- Use personal protection equipment (PPE) when conditions require it.
- Keep your hands and fingers away from the unused instrument terminals. When handling sensors or test probes, do not place fingers beyond the physical finger guard.

TABLE OF CONTENTS

1. INTRODUCTION.....	7
1.1 Receiving Your Shipment.....	7
1.2 Ordering Information.....	7
1.3 Accessories.....	8
1.4 Replacement Parts.....	8
2. OVERVIEW	8
2.1 Description.....	8
2.2 Insulation Resistance Testing Principal of Operation.....	9
2.3 Megohmmeter Models 6528 & 6529 — Front View.....	9
2.4 TEST Button and Function Keys.....	10
2.5 Instrument Display.....	10
2.6 Terminals.....	11
2.7 Configuration Mode.....	11
2.8 Alarm Buzzer.....	12
2.9 Permanent Mode.....	12
2.10 Backlight (BL).....	12
2.11 Firmware Version.....	12
2.12 Alarm Functions and Indicators.....	12
3. OPERATION.....	14
3.1 Battery Installation.....	14
3.2 Instrument Check.....	14
3.3 Power Supply and Battery Life.....	14
3.4 Stand, Door or Magnetic Mount.....	15
3.5 AC+DC or DC Voltage.....	15
3.6 Continuity.....	16
3.7 Resistance.....	17
3.8 Insulation Resistance Tests.....	18
4. MAINTENANCE.....	24
4.1 Cleaning.....	24
4.2 200mA Fuse Test.....	24
4.3 Battery and Fuse Replacement.....	24
5. GENERAL SPECIFICATIONS.....	25
6. ELECTRICAL SPECIFICATIONS.....	26
6.1 General Condition of Reference.....	26
6.2 AC/DC Voltage Measurement.....	26
6.3 Ground Bond Continuity Measurement.....	26
6.4 Ground Bond Resistance Measurement.....	26
6.5 Insulation Resistance Specification.....	27
7. REPAIR AND CALIBRATION.....	28
8. TECHNICAL AND SALES ASSISTANCE.....	28
9. LIMITED WARRANTY.....	29

1. INTRODUCTION

1.1 Receiving Your Shipment

Upon receiving your shipment, make sure that the contents are consistent with the packing list. Notify your distributor of any missing items. If the equipment appears to be damaged, file a claim immediately with the carrier and notify your distributor at once, giving a detailed description of any damage. Save the damaged packing container to substantiate your claim.

1.2 Ordering Information

Megohmmeter Model 6528 (Digital, 250V, 500V, 1kV, 420K-Ohm, V, Continuity, Alarm & Timer)..... **Cat. #2126.54**

Megohmmeter Model 6529 (Digital, 50V, 100V, 250V, 500V, 1kV,420k-Ohm, V, Continuity, Alarm & Timer, PI/DAR)..... **Cat. #2126.55**

Both models include soft carrying case, set of (2) 5 ft color-coded silicone leads, (2) color-coded alligator clips, (2) color-coded test probes (red/black), {Rated 1000V CAT IV, UL V2}, (6) 1.5V AA batteries and a user manual.



(1) of the following Megohmmeter Models:
Model 6528 **Cat. #2126.54** or
Model 6529 **Cat. #2126.55**

(1) Pouch – replacement for Models 1026, 6528, & 6529
(7 x 8.5 x 2")
Cat. #2117.73



Lead – set of (2), 5 ft silicone color-coded (red/black) with 4mm straight/right angle banana plugs (Rated 1000V CAT IV, UL)
Cat. #5000.94



Probe – black test probe (Rated 1000V CAT IV, 15A, UL V2)
Cat. #5000.97



Probe – red test probe (Rated 1000V CAT IV, 15A, UL V2)
Cat. #5000.98



Clip – safety alligator – black (Rated 1000V CAT IV, 15A, UL V2)
Cat. #5000.99



Clip – safety alligator – red (Rated 1000V CAT IV, 15A, UL V2)
Cat. #5100.00

Also includes 6 AA batteries and a user manual.

1.3 Accessories

Continuity Probe for use with Megohmmeters and Installation

Testers **Cat. #2138.54**



1.4 Replacement Parts

Pouch – replacement for Models 1026, 6528, & 6529 (7 x 8.5 x 2”)..... **Cat. #2117.73**

Lead – set of (2), 5 ft silicone color-coded (red/black) with 4mm straight/right angle banana plugs (Rated 1000V CAT IV, UL)..... **Cat. #5000.94**

Fuse – set of 2, FF, 200mA, 1000V, 10kA, 6x32mm..... **Cat. #2971.04**

Probe – black test probe (Rated 1000V CAT IV, 15A, UL V2)..... **Cat. #5000.97**

Probe – red test probe (Rated 1000V CAT IV, 15A, UL V2) **Cat. #5000.98**

Clip – safety alligator – black (Rated 1000V CAT IV, 15A, UL V2) **Cat. #5000.99**

Clip – safety alligator – red (Rated 1000V CAT IV, 15A, UL V2)..... **Cat. #5100.00**

For accessories and replacement parts, visit our store at www.aemc.com.

2. OVERVIEW

2.1 Description

The Megohmmeter Models 6528 and 6529 are portable measuring instruments with digital displays. They are powered by batteries. These instruments can check the safety of electrical insulation. For example, they can be used to test new insulation before they are powered up, check existing insulation in a power-off condition, or troubleshoot potential faulty insulation.

Features include:

	Model 6528	Model 6529
Insulation test voltages	250, 500, and 1000V	50, 100, 250, 500, and 1000V
Insulation Resistance	✓	✓
PI and DAR ratios calculation	–	✓
Continuity measurement	✓	✓
Resistance measurement	✓	✓
Programmable alarms	✓	✓

2.2 Insulation Resistance Testing Principal of Operation

Insulation resistance measurement is based on Ohm's Law. By applying a known DC voltage and then measuring the current flowing, the instrument can determine the value of the resistance. In principle, the value of the insulation resistance is very high, but not infinite. Therefore, by measuring the low current flowing, the instrument indicates the insulation resistance value, providing a result in kΩ, MΩ, or GΩ. This resistance characterizes the quality of the insulation and provides a good indication of the risks of leakage currents.

2.3 Megohmmeter Models 6528 & 6529 – Front View

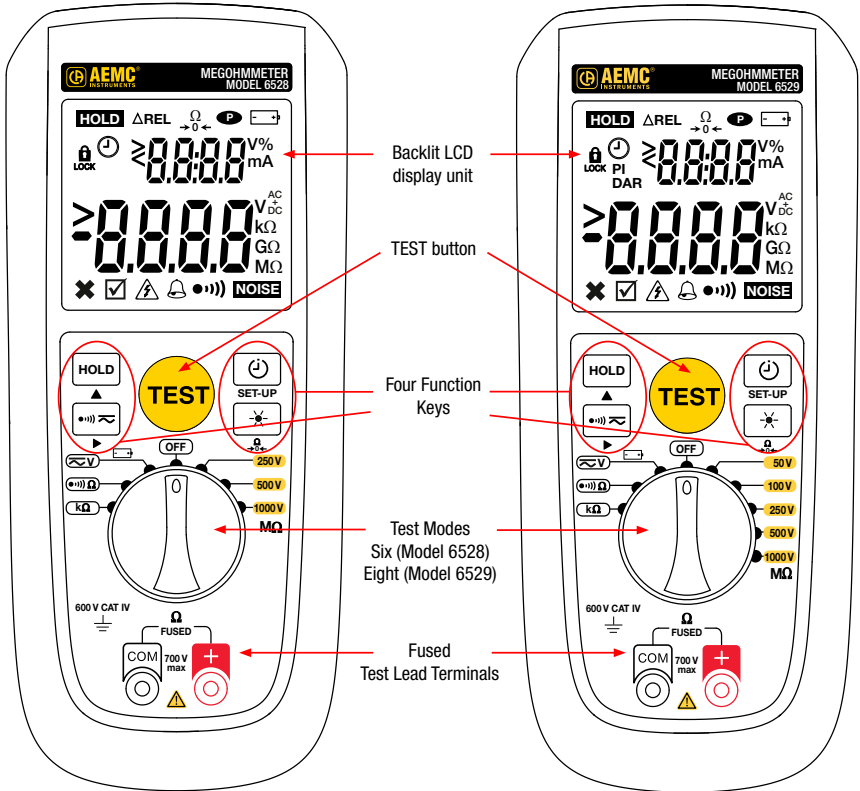

2.4 TEST Button and Function Keys

2.4.1 TEST Button

Pressing the **TEST** button starts an insulation measurement. It also serves to confirm a programmed threshold.



- Performs battery voltage check (§3.2)
- In resistance measurement, it is used to enter/exit the DMR mode and record the reference measurement (§3.7.1)
- Starts insulation resistance test (§3.8)

2.4.2 Function Keys

KEY	DESCRIPTION
	Freezes/unfreezes the measurement on the display. To unfreeze the display press HOLD key again. In SET-UP mode, the function of the key \blacktriangle is to cycle through parameters.
	Toggle between AC+DC and DC (§3.5) Activate/deactivate audible continuity indicator (§3.6) and insulation alarm (§3.7)
	Lightbulb (short press <2s) Activate/deactivate backlight (§2.10) Resistor (long press >2s) Perform lead compensation for continuity checks (§3.6.1)
	SET-UP (long >2s press): configure settings (§2.7) Clock (short press <2s): select type of insulation test (Lock , Clock), PI, DAR (Model 6529) (§3.8)
\blacktriangle , \blacktriangleright	Navigate the configuration menu (§2.7)

2.5 Instrument Display

1. Indicates the measurement is on hold.
2. Indicates the Differential Mode Resistance (DMR) or relative mode function is active in a resistance measurement.
3. Indicates the resistance of the leads is compensated in a continuity measurement.
4. Indicates auto-off is deactivated.
5. Indicates the remaining battery life.
6. Indicates that the measurement is within or outside of the alarm threshold set point.
7. Indicates the presence of a hazardous voltage.
8. Indicates the alarm is active in the insulation or DMR measurement mode.
9. Indicates the audible buzzer is activated.
10. Indicates a voltage interference in a continuity or resistance measurement.

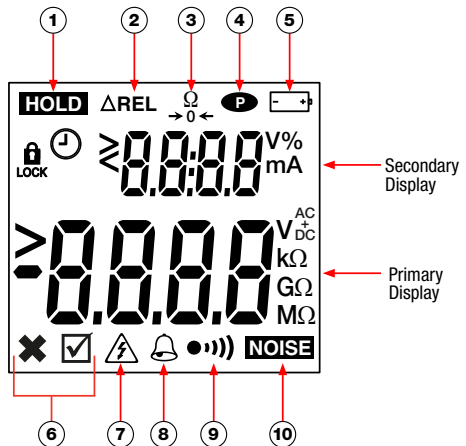

2.6 Terminals

The instrument has two measurement terminals: + (positive) and **COM** (common).

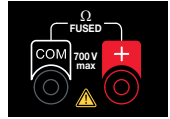



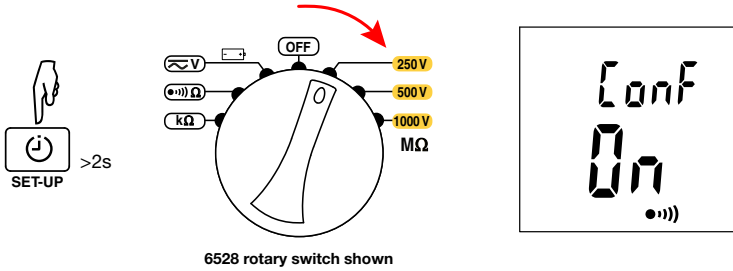

2.7 Configuration Mode

Configuration mode enables you to set several options for the instrument. To open configuration mode, turn the rotary switch to **OFF**. Then press and hold down the **SET-UP**  key for >2s while turning the rotary switch to any position. The symbol **ConF** appears on the LCD.



Pressing the **▲** key cycles through parameters, and the **▶** key selects the setting for the displayed option. Available parameters:

- | | | |
|-----------------------|---|---|
| |  | Insulation test mode buzzer enabled/disabled (§2.8) |
| 1st press on ▲ |  | Permanent mode enabled/disabled (§2.9) |
| 2nd press on ▲ |  | Backlighting enabled/disabled (§2.10) |
| 3rd press on ▲ |  | Firmware version number (display only, §2.11) |
| 4th press on ▲ | | Return to the first screen. |

Switch the instrument off by turning the rotary switch to **OFF**. All of your changes are applied the next time the instrument is turned **ON**.

2.8 Alarm Buzzer

To enable/disable the audible Alarm buzzer in Insulation mode:

1. Turn the rotary switch to **OFF**.
2. Press and hold down the **SET-UP** (⌚) key for >2s turning the rotary switch to any position. The LCD momentarily displays **ConF** to indicate the instrument is in configuration mode.
3. The (●●) symbol appears on the display. If this is set to **ON**, press ► to select **OFF**. When you restart the instrument, the Alarm Buzzer (●●) will be disabled.

2.9 Permanent Mode

To help prolong battery life, by default the instrument's auto-off is activated and turns off the display if it is idle for 10 minutes. Press the **TEST** button to awaken the instrument.

To deactivate auto-off:

1. Turn the rotary switch to **OFF**.
2. Press and hold down the **SET-UP** (⌚) key for >2s turning the rotary switch to any position. The LCD momentarily displays **ConF** to indicate the instrument is in configuration mode.
3. Press ▲ until (P) appears. If this is set to **OFF**, press ► to select **ON**.

When you restart the instrument, the auto-off is deactivated and the (P) appears on the LCD indicating the Permanent mode is active.

2.10 Backlight (BL)

To help prolong battery life, by default the instrument's Backlighting mode is deactivated (or auto-off of backlight is activated) and after 2 minutes the backlighting is switched off.

If you want the backlighting to stay on at all times:

1. Turn the rotary switch to **OFF**.
2. Press and hold down the **SET-UP** (⌚) key for >2s while turning the rotary switch to any position. The LCD momentarily displays **ConF** to indicate the instrument is in configuration mode.
3. Press ▲ until (BL) appears. If this is set to **OFF**, press ► to select **ON**. The next time the instrument is switched on, automatic switching off of the backlighting will be deactivated and the backlighting will stay on at all times once the (BL) key has been pushed while the instrument is actively on.

2.11 Firmware Version

To display the firmware version number currently running on the instrument:

1. Turn the rotary switch to **OFF**.
2. Press and hold down the **SET-UP** (⌚) key for >2s while turning the rotary switch to any position. The LCD will display **ConF**.
3. Press ▲ until **SOFT** appears; the firmware version appears in the primary display.

2.12 Alarm Functions and Indicators

2.12.1 Alarm Functions

The alarm functions make it possible to rapidly confirm that the readings are OK, without looking at the display. You can adjust the alarm function default settings by adjusting the thresholds.

There are 7 alarm thresholds:

Function	Default Threshold	Programmable Threshold
Insulation 50V*	50kΩ	from 10kΩ to 399.9MΩ
Insulation 100V*	100kΩ	from 20kΩ to 399.9MΩ
Insulation 250V	250kΩ	from 50kΩ to 3.999GΩ
Insulation 500V	500kΩ	from 100kΩ to 3.999GΩ
Insulation 1000V	1000kΩ	from 200kΩ to 9.99GΩ
Continuity	1Ω	1Ω or 2Ω
Resistance DMR	5%	from 0.1 to 3999.9%



* Model 6529 only

To program a threshold, set the switch to the desired function, long press the **SET-UP**  key for >2s and release it when the beep sounds. The instrument displays the current threshold with the first digit blinking.

Use the **▲** key to set the digit and the **▶** key to go to the next digit. When all 4 digits have been set, choose the unit number. Confirm by pressing the **TEST** button.



6528 rotary switch shown

To enable Alarm Mode, press the Alarm Buzzer  key. The symbols  and  are displayed. If the measurement is below the alarm threshold, the meter emits a continuous beep, the backlighting lights red and the **X** symbol is displayed.

3. OPERATION

3.1 Battery Installation

Place the batteries in the instrument as follows:

1. Use a Phillips screwdriver to remove the battery cover screw on the back of the instrument (see illustration on right).
2. Install the batteries, respecting polarity. Requires six AA (LR6) batteries.
3. Replace the battery cover and tighten the screw.

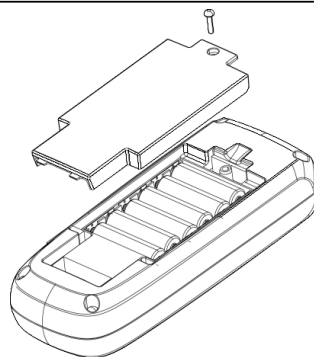

3.2 Instrument Check



We recommend performing the following steps when using the instrument for the first time, or after a long period without use.

1. Start the instrument. Ensure all display segments are displayed.
2. Perform a Continuity check (§3.6). Ensure the LCD displays $>42.0\Omega$ with no input connected. Then short circuit both terminals, the display should show 0Ω .
3. Turn the rotary switch to **V**, check a known voltage (e.g., a battery) and ensure that the measured voltage is correct.
4. Disconnect from the voltage source, and press the **TEST** button. The instrument's battery voltage is displayed. Ensure this is above 6.6V.
5. Turn the rotary switch to an insulation voltage setting (§3.7), and check a known resistor that is within the measurement range for the test voltage selected.
6. When all the steps above produce expected results, you can start using the instrument.

3.3 Power Supply and Battery Life

The power supply is six 1.5V alkaline batteries (type AA or LR6). Nominal voltage is 6.6 to 9.6V. Below 6.6V the instrument will not turn on.

- **Battery life for insulation measurements:** Average battery life for insulation measurement (according to IEC61557-2 clause 6.7) is 2000 measurements with new batteries at room temperature (5s ON, 25s OFF).
- **Battery life for voltage and resistance measurements:** Average battery life for voltage and resistance with new batteries at room temperature @ 400k Ω is $> 300h$.
- **Battery life for continuity checking:** Average battery life for continuity checking (according to IEC 61557-4 clause 6.6) is > 6000 measurements with new batteries at room temperature (5s ON, 25s OFF). For shorter continuity tests (0.8s ON, 10s OFF) battery life is $> 40,000$ tests.
- **Battery voltage:** To check the battery voltage, press and hold the **TEST** button with the switch set to the **V** position.

3.4 Stand, Door or Magnetic Mount

For convenience, the instrument can be used in different positions:

- With the stand - simply pull the back stand down to free it from its slot, then fold it and insert the end in the upper available slot.
- The stand can be placed on the top of a door or other similar surface by positioning the stand over the top edge as shown.
- The stand is equipped with magnets allowing the instrument to be attached to a metal surface.

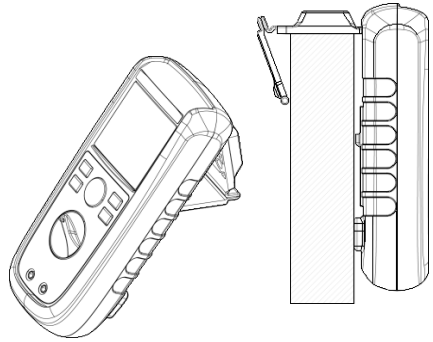

3.5 AC+DC or DC Voltage



The instrument measures AC+DC or DC voltage, to minimize risk when measuring an unknown voltage. Measure AC+DC voltage first. Be sure to respect the rated voltage and category.

If the measurement departs from the measurement range, the instrument displays **OL**.

1. Turn the rotary switch to the **V** position.
2. Toggle between AC+DC or DC voltage measurement by pressing the **●●●) ~** key.

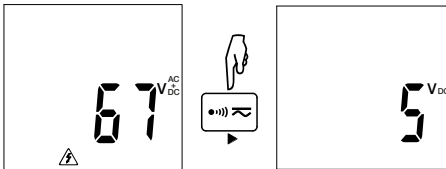

3. Connect the red test lead to the **+** terminal and the black test lead to the **COM** terminal.
4. Measure the voltage by attaching the test leads to the desired test points of the circuit.

Note: When the rotary switch is set to **V**, you can display the instrument's battery voltage by pressing and holding down the **TEST** key with no voltage present on the test leads. Releasing the key returns to voltage measurement mode.

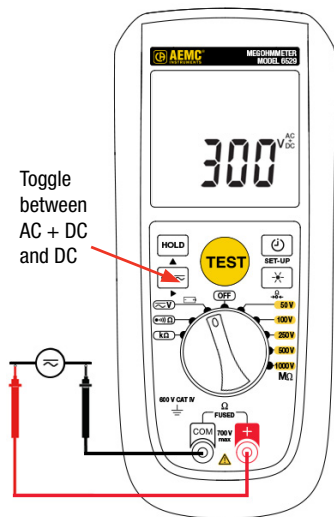

3.5.1 Voltage Error Indicators

- If the measurement is outside of the measurement range, the instrument displays **OL**.

3.6 Continuity



To avoid electrical shock and damage to the instrument when measuring resistance or continuity in a circuit, ensure power to the circuit is turned **OFF** and all capacitors are discharged.



The measurement can be affected by (1) impedances of additional operating circuits connected in parallel, or (2) transient currents.

In Continuity mode the instrument outputs a current above 200mA @ 2Ω between the + and **COM** terminals. The voltage across the circuit under test is measured by the instrument; this voltage is then used to calculate resistance ($R = V/I$).

1. Turn the rotary switch to **•••••** Ω.
2. The continuity threshold can be either 1Ω or 2Ω. To change this, press **SET-UP** for >2s. This displays the threshold setting. Press **▲** to change this, then press **TEST** to exit **SET-UP** mode.
3. Connect the red test lead to the + terminal and the black test lead to the **COM** terminal.
4. To compensate leads see §3.6.1.
5. Check continuity by connecting the leads to the desired point of the circuit. If resistance is under the threshold, the buzzer will sound, and will display on the LCD designating a short circuit. If the resistance is above the threshold, the backlight will light up red, the buzzer won't sound, and the LCD displays **×**. The LCD displays the measured continuity on its primary display and test current on the secondary display (§2.5). To activate the audible alarm signal, press the **•••••** key. The **•••••** symbol is displayed and a beep is emitted when the measurement is below the threshold. This lets you check that the continuity measurement is OK just by listening, without looking at the display.

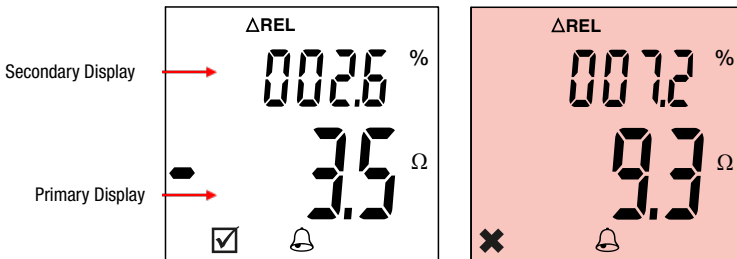

If you change the leads without redoing the compensation, the reading can become negative.

3.6.1 Compensation of the Measurement Leads

Short the input terminals by touching them together. Then press the $\rightarrow 0 \leftarrow$ key and hold it down for >2s. The LCD should display 0 Ω . If current is 0 mA when the terminals are shorted, verify the fuse is good.

NOTE: If the resistance of the leads is >5 Ω , compensation is not possible.

To remove test lead compensation, press $\rightarrow 0 \leftarrow$ for >2s with the test leads open. The buzzer can be disabled by pressing the alarm $\bullet \bullet \bullet \bullet$ key.

3.6.2 Continuity Alarm Indicators

- The alarm is always active in continuity measurement.
- The instrument gives you a choice of two alarm thresholds: 1 Ω or 2 Ω .
- If the measurement is below the threshold, the symbol is displayed.
- If the measurement exceeds the threshold, the backlighting lights turn red and the **X** symbol is displayed.

3.6.3 Continuity Error Indicators

- If the measurement is beyond the measurement range, the instrument displays >42.00 Ω .
- If during the measurement the **NOISE** symbol appears on the LCD, transient currents are affecting the measurement. Ensure the circuit under measurement is de-energized.
- When the measurement current is <200mA, the measurement is still correct but is no longer compliant with the IEC standard continuity measurements.
- The instrument displays the AC+DC voltage. If it is >30V, the Δ symbol is displayed to warn the user that the voltage on the terminals is hazardous and the instrument emits a pulsed beep.
- If there is a voltage of more than 0.4V on the object to be tested, the instrument displays **NOISE**.

3.7 Resistance

To perform a resistance test, the instrument outputs a DC voltage and measures the current across the circuit under test. The instrument then calculates the resistance.



To avoid electrical shock and damage to the instrument when measuring resistance or continuity in a circuit, ensure power to the circuit is turned **OFF** and all capacitors are discharged.

3.7.1 Differential Mode Resistance (DRM) Mode

In the resistance measurement mode, there is a very useful feature called the Differential Resistance Mode (DRM). It can be used as an incoming inspection tool, a radiant heat element qualifying tool or a quality check on production lines to name a few.

This is a valuable feature to compare successive measurements to a previously measured "reference" resistance. If the measurement falls outside a configured threshold percentage, a visual and audible alarm will occur.

Start by setting the threshold in %

1. Turn the rotary switch to the **k Ω** position.
2. Press and hold the **SET-UP** \odot key for >2s. The threshold percentage appears in the LCD secondary display area, with the first digit blinking.
3. You can adjust the percentage by pressing the \blacktriangle to increment the blinking digit and the \blacktriangleright to advance to the next digit.

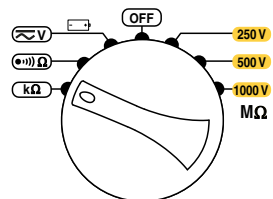

6528 rotary switch shown

- The threshold percentage can be set from 0.1% to 399.9%; default is 5%. When finished setting the threshold percentage, press **TEST** to exit **SET-UP** mode.
- Connect the red lead to the **+** terminal and the black lead to the **COM** terminal.
- Connect the test leads to the device to be used as the reference resistance. The resistance measurement will appear in the primary display area.
- Press the **TEST** button to accept that as the reference value. The **ΔRel** symbol will appear and the percentage difference will appear on the top line of the secondary display indicating the instrument is in **DRM** mode.

As you take subsequent measurements, the difference between the measurement and the reference is displayed both in ohms (primary display (§2.5)) and as a percentage (secondary display (§2.5)).

If the difference exceeds the threshold percentage, an alarm activates with a red back lit display and an audible buzzer (if enabled) indicating the out of tolerance condition.

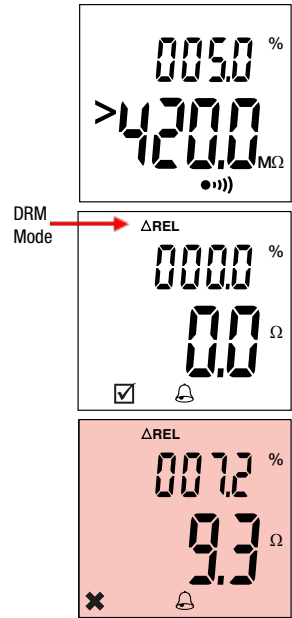

3.7.2 Resistance Mode Alarm Indicators

- Before starting an insulation measurement, pressing the **••••** key activates the alarm. The alarm threshold is displayed, along with the and **••••** symbols.
- If the measurement exceeds the threshold, the symbol is displayed.
- If the measurement is below the threshold, the instrument emits a continuous beep, the backlight turns red and the **X** symbol is displayed.

3.7.3 Resistance Mode Error Indicators

- If there is a voltage of more than 0.4V on the object to be tested, the instrument displays **NOISE**.
- If the object to be tested is at a hazardous voltage, >30V, the symbol is displayed and the instrument emits a pulsed beep.
- If the measurement is outside of the measurement range, the instrument displays >420.0kΩ.

3.8 Insulation Resistance Tests





To avoid electrical shock and damage to the instrument when measuring resistance or continuity in a circuit, ensure power to the circuit is turned **OFF** and all capacitors are discharged.



In Insulation Resistance mode the instrument outputs a DC voltage. This voltage depends on the resistance to be measured. The device measures the voltage and current present between the two terminals and determines the value of $R=V/I$.

You can perform up to five types of resistance tests, depending on instrument model. By default, the instrument is in “unlocked” untimed test mode. In this mode, the test begins when you press the **TEST** button, and ends when you release it. This mode is typically used to run short “spot” tests.

The other test types are selected via the **SET-UP**  key:

KEY	DESCRIPTION
1st press  LOCK	Lock the TEST button. In this mode, after you start the measurement, it continues without requiring you to keep the TEST button pressed. The test will run until you stop it, or when 40 minutes have passed.
2nd press 	Activate timed test mode. You can set the test duration between 1 second and 39:59 minutes.
3rd press Exit PI	Exit timed text mode (Model 6528). Enable the PI function (Model 6529). This is used to calculate the polarization index (the ratio of the measurement at T2 [default 10 minutes] to the measurement at T1 [default 1 minute]).
KEY	DESCRIPTION
4th press DAR	Enable the DAR function (Model 6529). This is used to calculate the dielectric absorption ratio (the ratio of the measurement at T2 [default 1 minute] to the measurement at T1 [default 30 seconds]).
5th press TEST	Exit timed test mode (Model 6529).

3.8.1 Untimed Test (Including Unlocked and Locked)

1. Turn the rotary switch to an insulation voltage setting, Choices are **250 V, 500 V, 1000 V** (available on both the Models 6528 and 6529), and **50 V and 100 V** (available on Model 6529 only). The test voltage to select depends on the operating voltage of the device to be tested.
2. To run an unlocked test, skip this step and continue with step 3. To lock the **TEST** button, press the **SET-UP**  key once. The  icon appears on the LCD.
3. To set an Alarm (§2.12).
4. Use the leads to connect the system to be tested to the instrument's terminals. The test sample must be powered down and discharged. When testing insulation, the typical connection is negative (black) lead to conductor and positive (red) lead to ground or the outer insulation of the test sample.
5. Press the **TEST** button to start the test.

If you are running an unlocked test, hold down the **TEST** button until the displayed measurement is stable.



If you are running a  test, release the **TEST** button.

Note that if the instrument detects a voltage greater than 30V in the system under test, pressing the **TEST** button has no effect because the test will be prohibited.

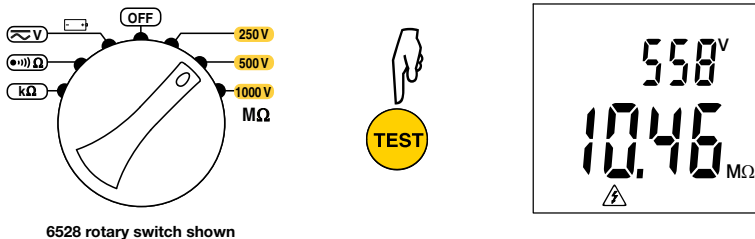
When the insulation measurement stabilizes, it appears on the primary display (§2.5). The secondary display (§2.5) shows the test voltage.



6528 rotary switch shown

- When performing insulation measurement, you can press the  key to enable the alarm feature. If the measurement falls below the alarm threshold, the alarm will activate. To set alarm threshold (§2.12).
- At the end of the test, either release the **TEST** button (for unlocked tests) or press the **TEST** button a second time (for  tests). The instrument stops generating the test voltage and discharges the device being tested. During this process the discharging voltage value is displayed to indicate residual voltage. The measured value will remain on the display until you make another measurement, press the **HOLD** key, or turn **OFF** the instrument. You can also start another measurement immediately by a long press on the **TEST** button.

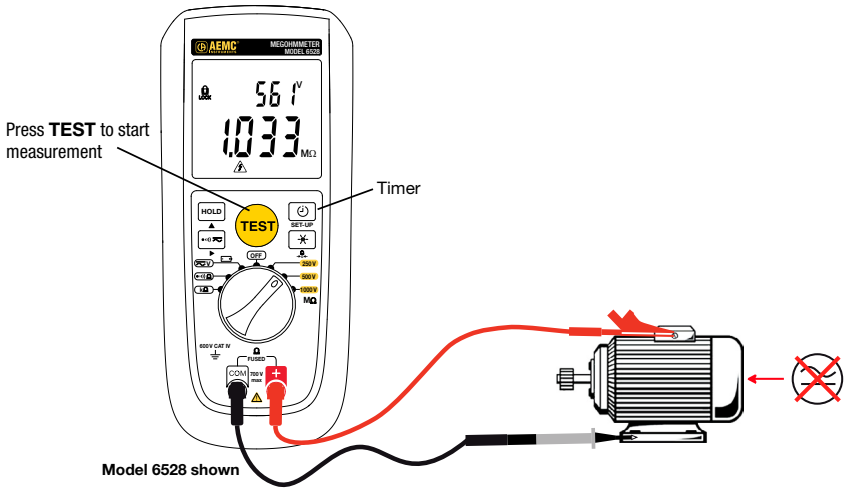

Do not disconnect the instrument while the  symbol is still displayed.

3.8.2 Timed Test (Including PI and DAR)

Both the Model 6528 and Model 6529 can perform timed tests that stop automatically after a defined duration. In addition, the Model 6529 can perform polarization index (**PI**) and dielectric absorption ratio (**DAR**) tests.

Polarization index is a useful indicator of motor insulation health. It can identify the accumulation of contaminants as well as any physical damage to the insulation itself. The test involves applying a positive charge to a motor's conductors and a negative charge to the motor frame therefore polarizing the insulation. This test essentially measures the change over time. Healthy clean insulation will charge over time resulting in the decrease of induced current and an increase in insulation resistance. Unhealthy insulation will result in a flat to decreasing insulation resistance over time.

The PI test compares the measurement of insulation resistance at two points in time. The most prominent used time points are at 1 and 10 minutes. Model 6529 defaults to these two test points labeled as T1 and T2. The instrument allows user programming of both time points if necessary. Acceptable values can be programmed between 1 second and 30 minutes for each test point. The time for T2 must be at least 1 second longer than T1.

The polarization index is calculated by dividing the insulation resistance value at point in time T2 (e.g., 10-min) by the insulation resistance value taken at point in time T1 (e.g., 1-min).



IEEE-43 recommends that good insulation will exhibit an increase in resistance at the 10-minute point that should be at least two times greater than the measurement taken at the one-minute point. Therefore, healthy insulation will exhibit a PI ratio of 2 or higher. Newer insulation material can progress through the absorption phase very quickly and therefore display a PI ratio of 1.

3.8.2.1 Conducting a Polarization Index (PI) Test (Model 6529)

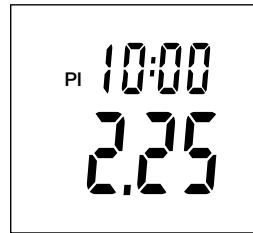
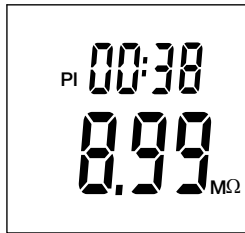
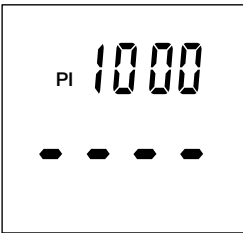
1. Select the desired insulation resistance test voltage using the rotary switch.
2. Turn the rotary switch to an insulation voltage setting. Choices are **50V**, **100V**, **250V**, **500V**, and **1000V**. The test voltage to select depends on the voltage of the installation to be tested.
3. Press the **SET-UP**  key three times until you see **PI** on the secondary display (§2.5) along with the test run time.
4. Press and hold the **TEST** button until the test begins.
5. The secondary display will then indicate a countdown timer showing the remaining time to complete the test. The primary display (§2.5) will show a real time value of the insulation resistance measurement in progress.
6. At the conclusion of the test the secondary display will show **PI** and the elapsed test time.
7. The primary display will show the **PI** ratio.



3.8.2.2 Programming the Polarization Index T1 and T2 Test Time Points

1. Select the desired insulation resistance test voltage using the rotary switch.
2. Press the **SET-UP**  key three times until you see **PI** on the top line of secondary display along with the test run time.
3. Press and hold the **SET-UP**  key >2s until the Alarm threshold is shown. Press **SET-UP** key again until **T1** appears and the leading time digit begins to blink. You can adjust the time for T1 by using the **▲** to increment the blinking digit and **▶** to advance to the next digit.
4. Once completed press the **SET-UP**  key again.
5. The time **T2** time will now appear in the display with the first digit blinking repeat the **▲** and **▶** arrow sequence to adjust the desired time for T2.
6. Press the test button **TEST** button to lock-in the new times for T1 and T2.

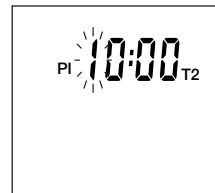
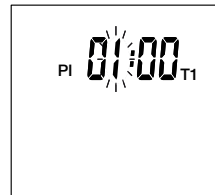

3.8.2.3 Conducting a Dielectric Absorption Ratio (DAR) Test

The dielectric absorption ratio test is typically accomplished by measuring the insulation resistance taken at the 30 second time interval and comparing it to the insulation resistance measurement at the 60 second time interval. The instrument allows user programming of both time points if necessary.

As with the PI ratio, these two time points are labeled T1 and T2.

The DAR ratio is then calculated by dividing the T2 measurement (e.g., 60 seconds) by the T1 measurement (e.g., 30 seconds).

Generally, ratios of 1.25 or less are considered questionable. Ratios between 1.25 and 1.6 are considered acceptable and ratios higher than 1.6 are considered good.

1. Turn the rotary switch to an insulation voltage setting. Choices are **250V**, **500V**, **1000V** (available on both the Models 6528 and 6529) and **50V** and **100V** (available on the Model 6529 only). The test voltage to select depends on the voltage of the installation to be tested.
2. Press the **SET-UP**  key four times until you see **DAR** in the secondary display along with the test run time.
3. Press and hold the **TEST** button until the test begins.



The top line of the secondary display will indicate a countdown timer showing the remaining time to complete the test. The bottom primary display will show a real time value of the insulation resistance measurement in progress.

At the conclusion of the test the secondary display will show **DAR** and the elapsed test time.

The bottom primary display will show the **DAR** ratio.

3.8.2.4 Programming DAR the T1 and T2 test time points

The instrument allows for user programming both time points if necessary. Acceptable values can be programmed between 1 second and 30 minutes for each test point. The time for T2 must at least 1 second longer than T1.

1. Select the desired insulation resistance test voltage using the rotary switch.
2. Press the **SET-UP**  key four times until you see **DAR** on the top line of display along with the test run time.
3. Press and hold the **SET-UP**  key >2s until the Alarm threshold is shown. Press **SET-UP** key again until **T1** appears and the leading time digit begins to blink. You can adjust the time for **T1** by using the **▲** arrow to increment the blinking digit and the **▶** arrow to advance to the next digit.
4. Once completed press the **SET-UP**  key again.
5. The time T2 will now appear in the secondary display with the first digit blinking; repeat the **▲** and **▶** arrow sequence to adjust the desired time for T2.
6. Press the **TEST** button to lock-in the new times for T1 and T2.

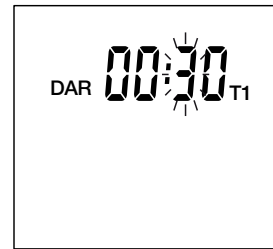



3.8.2.5 Performing a Timed Test

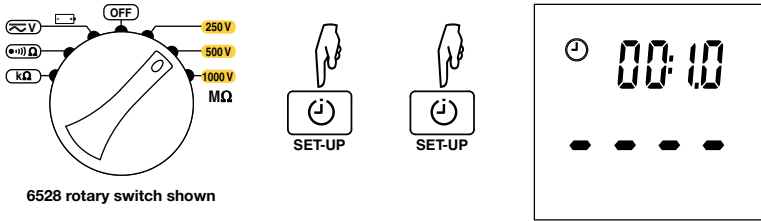

1. Turn the rotary switch to an insulation voltage setting. Choices are **250V**, **500V**, **1000V** (available on both the Models 6528 and 6529), and **50V** and **100V** (available on the Model 6529 only). The test voltage to select depends on the voltage of the installation to be tested.
2. Press the **SET-UP**  key two times to enter duration mode.

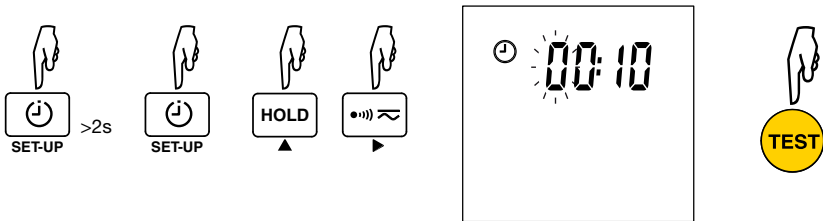

6528 rotary switch shown

3. To set an Alarm, see §2.12
4. Press and hold the **SET-UP**  key >2s until the Alarm threshold is shown. Press **SET-UP**  key again to display timer duration, with the leading time digit blinking. You can adjust the duration by using the **▲** arrow to increment the blinking digit and the **▶** arrow to advance to the next digit.



5. The insulation measurement time of duration can be programmed from 00:01 to 39:59 (from 1 second to 40 minutes) in the duration mode .
6. Press the **TEST** button to lock-in the new time duration for a timed test.
7. In the Timed Test  mode, simply long-press the **TEST** button to start the timed measurement. Test will stop automatically at the end of the programmed duration.

3.8.2.6 Insulation Resistance Mode Error Indicators

- The instrument displays the AC+DC voltage. If it is >30V, the  symbol is displayed to warn the user that the voltage on the terminals is hazardous, the instrument emits a pulsed beep and pressing the **TEST** button is restricted from performing a test.
- If the measurement is outside of the measurement range, the instrument displays **LO** (if the insulation resistance is too low to allow generation of the voltage) or >4200MΩ (for a test voltage of 50V,* 100V*, 250V or 500V) or >11.00GΩ (for a test voltage of 1000V). (*Model 6529 only.)
- If the instrument fails to generate a voltage, check the fuse (§4.3).

4. MAINTENANCE

The instrument has no parts that can be replaced by personnel who are not trained and approved. Any non-approved repair or other work, or replacement of a part by an “equivalent,” may severely compromise safety.

4.1 Cleaning

Periodically wipe the case with a damp cloth and mild detergent. Do not use abrasives or solvents. Dirt or moisture in the terminals can affect the readings. Dry the instrument thoroughly after cleaning and before use.

4.2 200mA Fuse Test



To avoid electrical shock, remove the test leads and any input signals before replacing the fuse.

1. Turn the rotary switch to **•••) Ω**.
2. Short circuit both terminals.
3. If the current measurement is 0, the fuse needs to be replaced.

4.3 Battery and Fuse Replacement



To avoid false readings, which could lead to possible electric shock or personal injury, replace the batteries with LR6 batteries as soon as the battery indicator  appears. To prevent damage or injury, install **ONLY** replacement fuses with the specified amperage, voltage, and interrupt ratings. Disconnect test leads before removing the battery cover.

Replace the batteries and fuse as follows:

1. Using a Phillips screw driver, remove the battery cover screw on the back of the instrument.
2. Remove the old batteries.
3. Install the batteries, respecting polarity.
4. Locate the fuse in its slot near the base of the instrument (indicated by the red square in the illustration to right).
5. Using a thin flathead screwdriver or similar implement, carefully remove the fuse.
6. Insert the replacement fuse (Fast Fuse 200mA 1000V 10kA size: 6.3 x 32mm), ensuring both ends are firmly pressed into the fuse holding clips.
7. Replace battery door and tighten the screw.

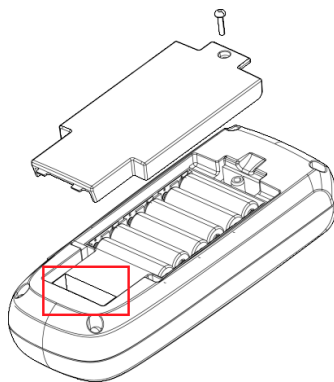

5. GENERAL SPECIFICATIONS

Maximum Voltage applied to terminals	700VRMS or DC
Storage temperature	-40 to 140°F (-40 to 60°C)
Operating temperature	14 to 122°F (-10 to 50°C)
Temperature coefficient	Insulation 4000PPM/°C, Ohm/Cont 2%/10°C+2D, V 0.3%/10°C+D
Relative humidity	10% to 90%
Operating Altitude	0 to ~6500' (0 to 2000m)
Electromagnetic compatibility	EN 61326-1, EN 61326-2-2
Safety	600V CAT IV, IEC 61010-2-034, IEC 61010-031,  us
Battery type	6x AA, NEDA 15A, IEC LR6
Battery life	See §3.3
Size (H x W x L)	8.54 x 3.54 x 2.44" (217 x 90 x 62mm)
Vibration	1mm 25Hz as per IEC61557
Weight	1.68 lbs (760g)
Conformity	CE, IEC61557-2, IEC61557-4, IEC61557-10
Mechanical conformity	IP40 with test leads connected: EN60529 IP20 without test leads connected: EN60529 Drop test according to IEC61010-1 Shock 0.5 J (IK04): IEC 68-2-27
Fuse	F1: Fast Fuse 200mA 1000V 10kA size : 6.3 x 32

6. ELECTRICAL SPECIFICATIONS

6.1 General Condition of Reference

Influencing Quantity	Conditions of Reference
Ambient temperature	73.4°F ± 5.4°F (23°C ± 3°C)
Relative humidity	[45%; 75%]
Electric field	≤ 0.1V/m AC
Power supply (batteries voltage)	8 to 9V

6.2 AC/DC Voltage Measurement

	Range	Resolution	Uncertainty ±(% of reading +Digits)
V _{AC+DC}	700V	1V	±(1.2%+1ct)
V _{DC}	700V	1V	±(1%+1ct)

Input impedance: 25MΩ
 Common mode rejection ratio: > 60dB
 Overload protection: 700VRMS or DC
 Frequency: 30 to 440Hz

6.3 Ground Bond Continuity Measurement

	Range	Resolution	Uncertainty ±(% of reading +Digits)
Continuity	40Ω	0.01Ω	±(1.2%+3cts)

Resistance of test leads: ≤ 0.01Ω (compensated)
 Overload fuse protection by fuse: 700VRMS
 Open circuit voltage: >6V and <9V
 Short circuit current: 0.02-2.00Ω: ≥ 200mA
 2.01-39.99Ω: between 100-200mA

6.4 Ground Bond Resistance Measurement

	Range	Resolution	Uncertainty ±(% of reading +Digits)
kΩ	400Ω	0.1Ω	±(1.2%+3cts)
	4kΩ	1Ω	
	40kΩ	10Ω	
	400kΩ	100Ω	

Resistance of test leads: ≤ 0.01Ω (compensated)
 Overload fuse protection by fuse: 700VRMS
 Open circuit voltage: 4.5V

6.5 Insulation Resistance Specification

Measurement range:	0.01MΩ to 10GΩ
Test voltages:	Model 6529: 50, 100, 250, 500, 1000V Model 6528: 250, 500, 1000V
Test voltage accuracy:	+25%, 0%
Nominal current:	1mA
Auto discharge:	Discharge time 2s for C=2μF
Live circuit detection:	Inhibit test if terminal voltage >30V prior to initialization of test
Maximum capacitive load:	2μF at nominal voltage and nominal current.

Output Voltage	Range	Display Range	Resolution	Test current	Uncertainty ±(% of reading + Digits)	
50V* (0% to +25%)	4MΩ	0.01 to 4.000MΩ	0.001MΩ	1mA @ 50kΩ	±(3%+10cts)	
	40MΩ	3.60 to 39.99MΩ	0.01MΩ			
	400MΩ	36.0 to 399.9MΩ	0.1MΩ			
100V* (0% to +25%)	4MΩ	0.020 to 4.000MΩ	0.001MΩ	1mA @ 100kΩ		
	40MΩ	3.60 to 39.99MΩ	0.01MΩ			
	400MΩ	36.0 to 399.9MΩ	0.1MΩ			
250V (0% to +25%)	4MΩ	0.050 to 3.999MΩ	0.001MΩ	1mA @ 250kΩ		±(1.5%+10cts)
	40MΩ	3.60 to 39.99MΩ	0.01MΩ			
	400MΩ	36.0 to 399.9MΩ	0.1MΩ			
	4GΩ	360 to 3,999MΩ	1MΩ		±(4%+10cts)	
500V (0% to +25%)	4MΩ	0.100 to 3.999MΩ	0.001MΩ	1mA @ 500kΩ	±(1.5%+10cts)	
	40MΩ	3.60 to 39.99MΩ	0.01MΩ			
	400MΩ	36.0 to 399.9MΩ	0.1MΩ			
	4GΩ	360 to 3,999MΩ	1MΩ		±(4%+10cts)	
1000V (0% to +25%)	40MΩ	0.20 to 39.99MΩ	0.01MΩ	1mA @ 1MΩ	±(1.5%+10cts)	
	400MΩ	36.0 to 399.9MΩ	0.1MΩ			
	4GΩ	360 to 3,999MΩ	1MΩ			±(4%+5cts)
	10GΩ	3.60 to 9.99GΩ	.01GΩ		±(10%+10cts)	

* Model 6529 only

Capacitance in parallel: <1nF

External voltage in series: 0.0V

Common mode voltage: 0.0V

7. REPAIR AND CALIBRATION

To ensure that your instrument meets factory specifications, we recommend that it be scheduled back to our factory Service Center at one-year intervals for recalibration, or as required by other standards or internal procedures. For instrument repair and calibration:

You must contact our Service Center for a Customer Service Authorization Number (CSA#). This will ensure that when your instrument arrives, it will be tracked and processed promptly. Please write the CSA# on the outside of the shipping container. If the instrument is returned for calibration, we need to know if you want a standard calibration, or a calibration traceable to N.I.S.T. (Includes calibration certificate plus recorded calibration data).

Ship To: Chauvin Arnoux®, Inc. d.b.a. AEMC® Instruments

15 Faraday Drive • Dover, NH 03820 USA

Phone: (800) 945-2362 (Ext. 360)

(603) 749-6434 (Ext. 360)

Fax: (603) 742-2346 or (603) 749-6309

E-mail: repair@aemc.com (Or contact your authorized distributor)

Costs for repair, standard calibration, and calibration traceable to N.I.S.T. are available.



NOTE: You must obtain a CSA# before returning any instrument.

8. TECHNICAL AND SALES ASSISTANCE

If you are experiencing any technical problems, or require any assistance with the proper operation or application of your instrument, please call, fax, or e-mail our technical support team:

Chauvin Arnoux®, Inc. d.b.a. AEMC® Instruments

Phone: (800) 343-1391

(508) 698-2115

Fax: (508) 698-2118

E-mail: techsupport@aemc.com

9. LIMITED WARRANTY

The instrument is warranted to the owner for a period of two years from the date of original purchase against defects in manufacturing. This limited warranty is given by AEMC® Instruments, not by the distributor from whom it was purchased. This warranty is void if the instrument has been tampered with, abused, or if the defect is related to service not performed by AEMC® Instruments.

The warranty does not apply in the following cases:

- Inappropriate use of the equipment or use with incompatible equipment
- Modifications made to the equipment without the explicit permission of the manufacturer's technical staff
- Work done on the device by a person not approved by the manufacturer
- Adaptation to a particular application not anticipated in the definition of the equipment or not indicated in this user's manual
- Damage caused by shocks, falls, or floods

Full warranty coverage and product registration is available on our website at: www.aemc.com/warranty.html

Please print the online Warranty Coverage Information for your records.

What AEMC® Instruments will do:

If a malfunction occurs within the warranty period, you may return the instrument to us for repair, provided we have your warranty registration information on file or a proof of purchase. AEMC® Instruments will, at its option, repair or replace the faulty material.

NOTES:

NOTES:



10/20

99-MAN 100491 v1

Chauvin Arnoux®, Inc. d.b.a. AEMC® Instruments

15 Faraday Drive • Dover, NH 03820 USA

Phone: (603) 749-6434 • Fax: (603) 742-2346

www.aemc.com