

## OVERVIEW

The Metrix Digital Proximity System (DPS) combines the performance of a fully API 670 compliant eddy-current proximity measurement system with the flexibility of digital configurability. For the first time in our industry, users can configure their transducer system in the field using a custom field-generated curve as well as factory pre-configured calibrations for a variety of probe tip diameters, manufacturers, extension cable lengths, target materials, and linear ranges. Refer to page two of this datasheet for additional details on device configurability.

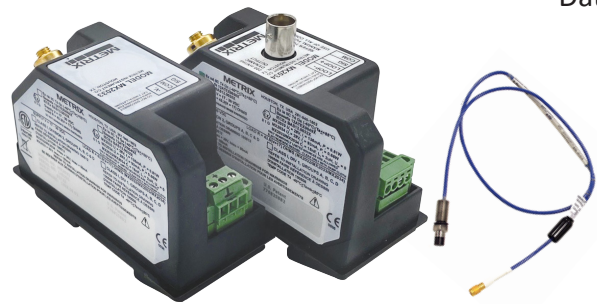

The DPS consists of three elements: a Probe, Extension Cable, and Driver or Transmitter.

### MX8030 & MX2030 PROBE SERIES

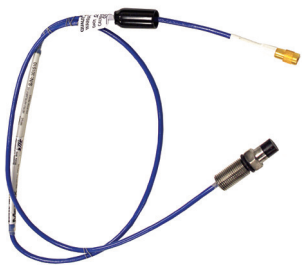

The MX8030 and MX2030 probe series consist of 5mm and 8mm tip diameter probes. The MX8030 comes standard with triaxial cable and VibeLock™5 connector. The MX2030 comes standard with a coaxial cable and rounded knurled connectors. Both probes offer a full 80 mil (2mm) range, and are designed to offer full API 670 compliance when used with a matching MX8031 or MX2031 extension cable and a MX2033 driver or a MX2034 transmitter.

MX8030 and MX2030 probes are fully interchangeable with Bently Nevada (BN)<sup>4</sup>, 3300 and 3300XL 5mm/8mm probes.

### MX8031 & MX2031 EXTENSION CABLES



Available in a variety of lengths and with optional protective cable armor. The MX8031 extension cable comes standard with triaxial cable and VibeLock™5 connector. The MX2031 comes standard with a coaxial cable and rounded knurled connectors.

The MX8031 and MX2031 Extension Cables are compatible with both Metrix MX8030 and MX2030 5mm/8mm probes and BN 3300 and 3300XL 5mm/8mm probes.

### PROBE DRIVER OR TRANSMITTER

A driver or transmitter is available, depending on the required signal output format: the MX2033 3-Wire Driver is used with monitoring systems and the MX2034 4-20 mA Transmitter is used with control systems. These models are fully compatible with a large variety of probes and cables from Metrix, BN, and other manufacturers.

#### MX2033 3-Wire Probe Driver

##### Dynamic Voltage Output (mV/μm or mV/mil)

MX2033 signal output is compatible with industry-standard continuous vibration monitoring systems and is in the format specified in API Standard 670. It uses -24Vdc excitation and provides the output signal in mV/μm, typically 7.87 mV/μm (200mV/mil).



#### MX2034 4-20 mA Transmitter

##### Static Current Output (mA/μm or mA/mil)

MX2034 signal output provides thrust, radial vibration, or shaft speed measurements directly to PLCs, DCSs, SCADA systems, or other instrumentation that accepts an ISA Standard 4-20 mA signal, without the use of a separate monitor system. The transmitter is a +24 Vdc current loop powered device.



Note: The above units can come with screwed in or push-pin terminal blocks.

FEATURES AND BENEFITS

Digitally Configurable

Metrix pioneered the patented technology used in the DPS which provides numerous performance and user-convenience benefits. Developed in 2005 for our vibration transmitters, the technology has proven itself in tens of thousands of installations worldwide. You can configure the device using the included software<sup>1</sup> in three ways:

- **METHOD #1** - By ordering per this datasheet (refer pages 7 and 8).
- **METHOD #2** - By using the included software to change the configuration to any of the available options for MX2033 drivers and MX2034 transmitters (refer to pages 7 and 8 respectively).
- **METHOD #3** - Generate a custom curve in the field<sup>2</sup> by recording the gap voltage at increments specified by the software. A custom linearization table is then generated and loaded into the device.

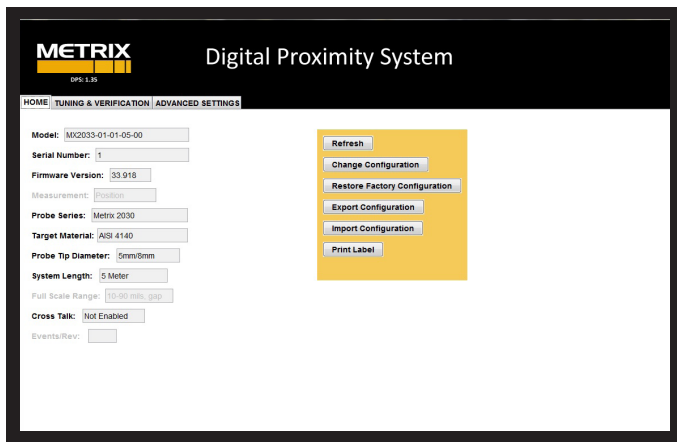

These configuration options provide the user with maximum flexibility and accuracy in adapting a single driver or transmitter device to the following parameters:

- Target material (including unknown or undetermined materials)
- Probe series and tip diameters from various manufacturers
- Extension cable lengths
- Position, thrust, radial vibration or speed measurement<sup>3</sup>
- Full scale range<sup>3</sup>
- Upscale/downscale direction<sup>3</sup>

The driver or transmitter is configurable via a USB port, protected under the baseplate of the device. The DPS configuration software is available as a free download at metrixvibration.com.

The DPS Configuration Software features a simple, intuitive user interface that makes it easy to configure the driver & transmitter in the field. Users can select from a discrete list of factory pre-configured curves using drop-down boxes, or generate a custom linearization curve in the field by entering gap voltages at increments specified by the software.

User Labels

Configured DPS units can easily be identified in the field using the DPS configuration software and our optional Metrix User Label Kit P/N 100527 (see Accessories on page 11). The kit consists of specially shaped polycarbonate overlay labels and paper labels (Avery 6570). The customized details are printed on an Avery 6570 label, and this is affixed under a clear rectangular window in the polycarbonate overlay label, providing a weatherproof seal. Target material, probe type and series, system length, and output sensitivity can be recorded. We provide user-configurable fields where you can record installation- and device-specific details such as date of last calibration, instrument loop tag numbers, probe location (machine / bearing / angular orientation), and any other details useful to machinery and instrumentation personnel.

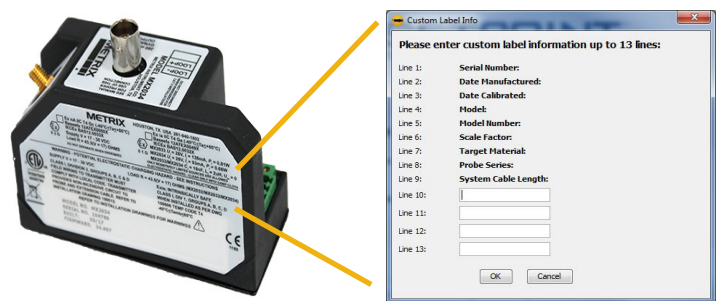

A user-generated label can be printed in the field with all device characteristics as well as user-specific tagging and installation particulars.

NOTES:

1. One can download the Metrix Digital Proximity System (DPS) software from metrixvibration.com.
2. Custom curves assume standard supported probe types (MX2033/MX2034 option BB) and system lengths (MX2033/MX2034 option CC), and that mismatched systems will not be used, such a 7200 cable with an MX2030 probe. Certain material types may limit total available linear range and other specifications. These can be quantified when a material sample is provided to the factory.
3. These settings are applicable to MX2034 transmitters only.
4. Registered trademark(s) of Bently Nevada®.
5. Registered trademark(s) of Metrix®.

## FEATURES AND BENEFITS (Continued)

### API 670 Compliance

The DPS was designed to fully comply with API 670 for linear range, interchangeability, standard probe configurations, and all other details.

### Reduced Spare Parts Inventory

The DPS reduces the requirements for spare parts by allowing a single type of driver or transmitter to be field-configured for a wide range of probe types, cable lengths, and target materials.

### Interchangeability

The Metrix 10,000 Series MX8030 and MX2030 probes and MX8031 and MX2031 extension cables are fully interchangeable with BN 3300 and 3300XL 5mm/8mm probe systems. Such compatibility provides greater choice of suppliers without the need to replace installed probes, cables and drivers.

### Support for Older Probe Systems

Replacing a complete proximity transducer system including probes/cables buried inside a machine can be expensive and impractical when a machine must keep running. The ability to support older probe systems is becoming increasingly important as users push their plant outage intervals to more and more years. Imagine being able to support not only a multitude of older probe systems, cable lengths, and target materials, but to be able to do so with just a single driver or transmitter. MX2033 drivers and MX2034 transmitters allow the user to change the configuration in the field for use with virtually any Metrix or BN proximity probe and cable (see ordering information on page 7 and 8 for currently supported probe systems).

## SPECIFICATIONS

The specifications on the following pages are based upon the following system components, target materials, gaps and temperatures<sup>1,2</sup> within the Metrix 10,000 proximity probe and cable series:

- MX2033 3-wire driver
- MX8030/MX2030 8mm probe with 0.5m cable
- MX8031/MX2031 4.5m extension cable
- AISI 4140 steel target gapped at 50 mils (1.27mm) from probe tip
- Temp = 22° C
- 17  $\mu\text{A}_{\text{RMS}}$  current loop noise floor

Specifications for MX2034 loop-powered transmitters assume the same probes, cables, target materials, temperatures, and current loop noise floor as shown above.

Interchangeability and accuracy specifications assume the above Metrix products and target materials; they may differ when components from other manufacturers are mixed with Metrix components<sup>3</sup>.

### NOTES:

1. The American Petroleum Institute (API) Standard 670 defines two temperature ranges for proximity probe systems: Testing Range and Operating Range. Except as otherwise noted, all specifications herein are for system performance at 22°C, in the middle of the API 670 Testing Range (0°C – 45°C).
2. Target materials other than AISI 4140 steel may restrict the transducer system's linear range and other specifications. Consult the factory whenever using a non-4140 target to ensure the transducer system will be suitable for the intended measurement range and accuracy requirements. The accuracy limitations on page 5 of this Datasheet should be increased by +/- 5% from the stated values when using a non-4140 target material.
3. A manufacturer's interchangeability specifications are based on statistical variations against their own reference transducer system. Because the reference transducer systems used by other manufacturers are not within the control of Metrix, interchangeability specifications for mixed systems cannot be guaranteed, but will generally be about twice as large as when all transducer system components come from a single manufacturer. However, where known, these differences can be compensated in the field using the transducer system's configurability capabilities, allowing mixed system performance to meet or exceed that of a non-mixed system.

SPECIFICATIONS (Continued)

ELECTRICAL

**Channels:** Driver or transmitter accepts one probe and extension cable

**Supported Probe Types:**

MX2033 driver and MX2034 transmitters are compatible with the probes and extension cables as shown.

PROBE SERIES	TIP DIAMETER	METRIX DATASHEET
MX8030 and MX2030	5mm/8mm	1507096
Metrix and BN 3000	.190"/.300"	1004736
Metrix and BN 7200	5mm/8mm	1009553
BN 3300 and 3300XL	5mm/8mm	N/A
Metrix 7200	11mm	1004596
BN 3300XL	11mm	N/A

Contact factory if you need other probes or cables.

**Driver or Transmitter**

**Excitation Voltage:**

(Reduced linear range will occur when voltage at the driver or transmitter terminal is more positive than -19 Vdc)

MODEL	W/O BARRIERS	W/ZENER BARRIERS	W/GALVANIC BARRIERS
MX2033	-17 to -30 Vdc	-23 to -26 Vdc	-20 to -30 Vdc
MX2034	17 to 30 Vdc	23 to 26 Vdc	20 to 30 Vdc

**Driver or Transmitter**

**Max Current Consumption:**

MODEL	I <sub>MAX</sub>
MX2033	10 mA
MX2034	23 mA

**Suggested Probe Gap:**

MODEL	VOLTS
MX2033	-9V
MX2034	+9V

**Driver or Transmitter**

**Output Types:**

MX2033 - Terminal: 5mm & 8mm (7.87 mV/μm (200 mV/mil)), 11mm (3.93 mV/μm (100 mV/mil)) (instantaneous gap)  
 MX2034 -

	TERMINAL	BNC
Radial vibration	Proportional 4-20 mA (mils pk-pk, μm pk-pk) <sup>1</sup>	Terminal: 5mm & 8mm (7.87 mV/μm (200 mV/mil)), 8mm Extended Range & 11mm (3.93 mV/μm (100 mV/mil)) (instantaneous gap)
Axial position	4-20 mA proportional to position (mils, μm) <sup>1</sup>	
RPM	4-20 mA proportional to speed	

**Field Wiring Gauge:**

Recommended: 0.8 mm<sup>2</sup> (18 AWG)  
 Allowed: 0.2 to 1.3 mm<sup>2</sup> (16 to 24 AWG)

**Field Wiring Type and Max Length:**

- MX2033: 3-conductor shielded cable, maximum length 300 m (1000 ft) driver to monitor. If the frequency content is going to be less than 2000 Hz, for example machines with fluid film bearings operating at or less than 60 Hz, then the maximum length is 600 m (2000 ft) driver to monitor.<sup>2</sup>
- MX2034: 2-conductor shielded cable for 4-20 mA and Dynamic Signal Output if applicable
- MX2034: 4-20 mA: maximum length 5000 m (16,400 ft) transmitter to Control System<sup>3</sup>, and Dynamic Signal Output: 100 m (325 ft).
- MX2034: RG-58 A/U coax cable (BNC connector), maximum length 5 m (16 ft)

**Min. Target Size:**

15.2 mm (0.6 in) diameter (assuming flat surface)

**Min. Shaft Diameter:**

Minimum: 50.8 mm (2.0 in), TightView-XY (to 12.7mm(0.5in))

**Linear Range:**

PROBE TYPE	RANGE
MX8030 and MX2030 (5mm/8mm)	2mm or 80 mils*
BN 3300 and 3300XL (5mm/8mm)	
Metrix and BN 7200 (5mm/8mm)	1mm or 40 mils*
Metrix and BN 3000 (.190 in)	
Metrix and BN 3000 (.300 in)	1.25mm or 50 mils**
BN NSv and RAM	1.5mm or 60 mils*
MX8030 Extended Range (8mm) and Metrix 7200 and BN 3300XL (11mm)	4mm or 180 mils

All Metrix proximity probes and cables fall under the 10,000 series.

\* Range starts at approx. 10 mils (250μm) gap (-1V)

\*\* Range starts at approx. 20 mils (500μm) gap (-1V)

NOTES:

1. For vibration and position the current output will be driven to the less than 3 mA if probe to target is out of 10-90 mil range for 5mm/8mm probe or 20-180 mil for MX8030 Extended Range and 11mm probe system.
2. Length limit is imposed by distributed cable capacitance and corresponding frequency response roll-off. Assumes standard 18 AWG 3-conductor cable with capacitance of 290 pF/m, no I.S. barriers. Total cable capacitance in excess of 450 nF will limit frequency response at monitor to less than published 10-kHz specification. Consult the manual (Metrix Document 100545) for further details.
3. Length limit is imposed by distributed cable resistance and corresponding voltage drop at maximum current output. Assumes 18 AWG 2-conductor cable with resistance of 20 Ω/km, 24 V<sub>dc</sub> supply voltage, 250 Ω load resistance, no I.S. barriers. Consult the manual for further details.



**Frequency Response:**

MODEL	± 3dB RESPONSE		
MX2033	0-10 kHz		
MX2034	Vibration Configuration (Option FFF=001-049)	Position Configuration (Option FFF=050-098)	Speed Configuration (Option FFF=103-753)
	4-20 mA: 5 Hz - 5 kHz	4-20 mA: 0 - 1.2 Hz	4-20 mA: 0 -XXXXX rpm
	Buffered: 0 - 5 kHz	Buffered: 0 - 5 kHz	Buffered: 0 - 5 kHz

**4 - 20 mA Update Rate:** 150 ms (applies to MX2034 only)

**Incremental Scale Factor (ISF)<sup>1-4</sup> and Deviation from Best-Fit Straight Line (DSL):**

PROBE TYPE	ISF (Incremental Scale Factor)	DSL (Deviation from Straight Line)
MX8030 and MX2030 (5mm/8mm)	7.87 mV/μm ± 5% (200 mV/mil)	± 0.025 mm (± 1 mil)
BN 3300 and 3300XL (5mm/8mm)		
Metrix and BN 7200 (5mm/8mm)	7.87 mV/μm ± 10% (200 mV/mil) <sup>5,6</sup>	± 0.06 mm (± 2.4 mil) <sup>5,6</sup>
Metrix and BN 3000 (.190")		
Metrix and BN 3000 (.300")	7.87 mV/μm ± 20% (200 mV/mil)	± 0.1 mm (± 3.9 mil) <sup>5,6</sup>
MX8030 Extended Range (8mm), 7200 and BN 3300XL (11mm)		
BN NSv and RAM	3.93 mV/μm ± 10% (100 mV/mil) <sup>5</sup>	± 0.075 mm (± 3 mil) <sup>5</sup>
	7.87 mV/μm ± 20% (200 mV/mil) <sup>5</sup>	± 0.06 mm (± 2.4 mil) <sup>5</sup>

**NOTES:**

1. Values shown are for 5m systems. For 9m systems, allow an additional ±1.5% ISF and DSL variance. These variances assume a 4140 Target Material, see note 2 page 3 for other materials.
2. Use of proximity probe system components from other manufactures may introduce measurement errors. For other manufacturer Interchangeability errors, when measured in increments of 0.25 mm (10 mils) over the linear range between 65°C and -35°C (API Operating Range), allow an additional ±1.5% ISF and DSL variance.
3. ISF shown assumes mV-type output and is valid for MX2033 and BNC connector on MX2034.
4. Above ISF values for MX2034 transmitter pertain only to the BNC connector, however, the API 670 standard for ISF for the transmitter’s 4-20mA proportional output is attainable when configured for Position and Vibration (for vibration calibration checks, the design and calibration errors on the vibration input device must be included, typically for a shaker up to 8%). When an MX2034 transmitter is configured for speed, proportional output error is less than 1%.
5. For these legacy systems, the ISF variance stated is for the API 670 Test Range -0°C to +45°C (+32°F to +110°F) with a 10-point custom calibration. Outside the Test Range, but within the API 670 Operating Range -35°C to +65°C (-30°F to +150°F) the allowable variance is ±25%.
6. To meet the accuracy of the above table, for 7200 and 3000 series probe systems, a two point tuning step using the DPS software may be required.

**MECHANICAL**

**Driver and Transmitter Case Material:** PBT thermoplastic polymer blend (contains PBT, carbon fiber, and glass beads)

**Connector Torque:** Maximum: 0.565 N-m (5 in-lb)  
Recommended: finger tight

**ENVIRONMENTAL**

**Working and Storage Temperature:** Driver or Transmitter: -40°C to +85°C (-40°F to +185°F)

**Relative Humidity:** 95%, non-condensing

**Patents:** Digital performance curve technology in driver and transmitter: US patent number 7768258.

**RECOMMENDED BARRIERS**

**Passive Zener:** MX2033: MTL 7796- (or equivalent)  
MX2034: MTL 7787+ (or equivalent)

**Active Galvanic:** MX2033: MTL 5531, P&F KFD2-VR4-Ex1.26, or equivalent  
MX2034 (DD=5/6): Loop Power: MTL 5541, P&F KFD2-STC4-Ex1, or equivalent  
MX2034 (DD=7/8): Loop Power: P&F KFD1-STC4-Ex1, or equivalent for terminals 1+ & 3-  
Dynamic Signal: P&F KFD2-VR-EX1.19-Y109129, or equivalent for terminals 4+ & 5-

**WEIGHT AND DIMENSIONS**

**Dimensions:**  
MX2033 Driver: See Fig 1, page 6  
MX2034 Transmitter: See Fig 2, page 9

**Weight:**  
MX2033 Driver: 247 g (8.7 oz)  
MX2034 Transmitter: 247 g (8.7 oz)

**ACCESSORIES**

**Mounting Options for MX2033 and MX2034:**

- 35mm DIN rail (standard)
- 4-hole flat base with 2" x 2" and 2.5" x 2.75" hole patterns (requires optional adapter P/N 9647)



HOW TO ORDER MX2033

MX2033-AA-BB-CC-DD (DPS 3-WIRE PROBE DRIVER)					
A	A	Material Calibration <sup>1,3</sup>	B B Probe Type	C C System Length*	D D Approvals**
0	1	AISI-SAE 4140 CrMo Steel <sup>1</sup>	0 1 5mm & 8mm – MX2030/BN 3300/BN 3300XL	0 5 5 meter <sup>4,9</sup>	0 0 None
0	2	17-4 Stainless Steel	0 2 5mm & 8mm – Metrix 7200/BN 7200	0 7 7 meter <sup>5</sup>	0 5 Multiple Approvals <sup>8</sup> (No Dynamic Signal)
0	3	Incoloy 901	0 3 0.190" – Metrix 3000/BN 3000	0 9 9 meter <sup>6,9</sup>	0 6 Custom Union & KOSHA Approval (No Dynamic Signal)
0	4	K500 Monel	0 4 0.300" – Metrix 3000/BN 3000	1 5 15 feet <sup>7</sup>	
0	5	Inconel 625	0 5 BN NSv and RAM	2 0 20 feet <sup>7</sup>	
0	6	410 Stainless Steel	0 6 11mm Metrix 7200 (CC option 05 and 09 only)		
0	7	316 Stainless Steel	0 7 11mm BN 3300XL (CC option 05 and 09 only)		
0	8	AISI-SAE 1040/1045 Plain Carbon Steel	0 8 5mm & 8mm – MX8030/BN 3300/BN 3300XL		
0	9	416 Stainless Steel	0 9 8mm – TightView MX8030 <sup>10</sup>		
1	0	42CrMo4	1 0 5mm – TightView MX2030 <sup>10</sup>		
1	1	18CrNiMo7-6			
1	2	31CrMoV9			
1	3	ST52-3			
X	X	Other materials see page 11	1 8 8mm – Extended Range MX8030 (CC Option 05 and 09 only)		

\*Systems up to 12 meters available for vibration. Systems up to 20 meters available for thrust and speed. For system lengths other than listed contact factory.

\*\*For a SIL rating replace the first digit in the DD option with an S.

Figure 1: Dimensions in inches [mm] for the MX2033 3-wire digital proximity driver.

Note: optional 4-hole baseplate mounting adapter shown (P/N 9647). 35mm din rail mount is standard.

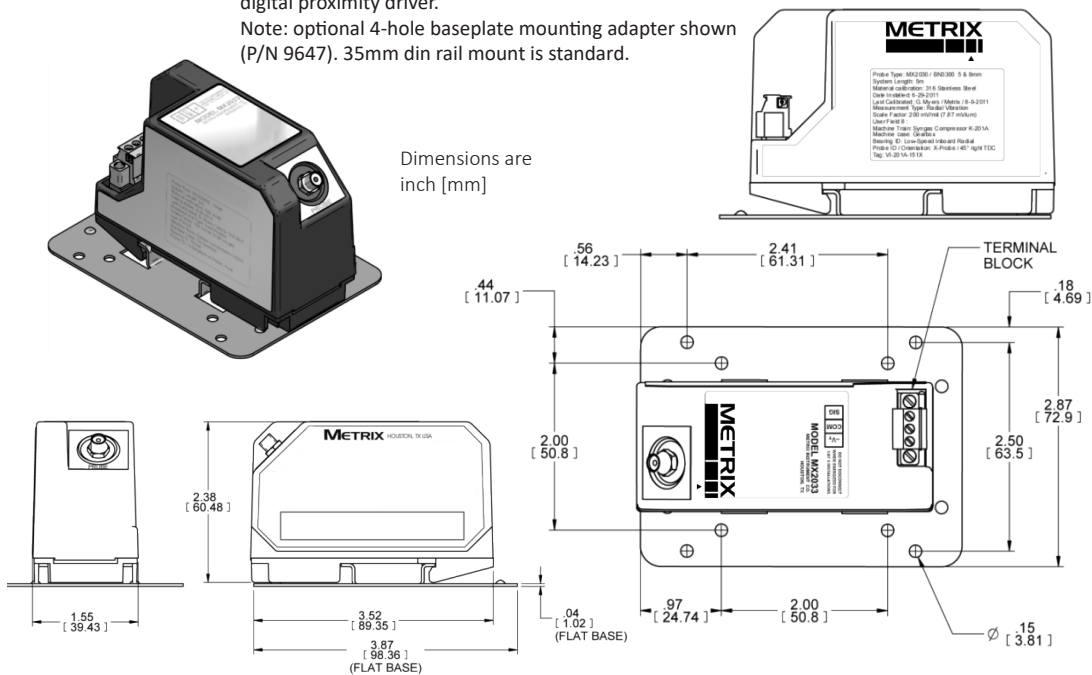

NOTES:

1. AISI-SAE 4140 chromium molybdenum steel is the standard default calibration per API 670. If no material type is specified at time of ordering, a factory-standard AISI 4140 target will be used. Calibration to target materials other than 4140 may restrict linear range and other specifications. Consult the factory.
2. Due to the electrical properties of this material, vibration measurement accuracy may be affected when using this target.
3. Calibration to other material types is available upon request. Metrix will normally request that the customer supply a suitable sample of the material, allowing a machined target with appropriate surface finish to be produced.
4. Compatible with BN 7200, 3300, 3300XL, NSv, and Metrix MX2030, MX8030 probes only.
5. Compatible with BN NSv and RAM probes (BB=05), MX2030 (BB=01, 10), MX8030 (BB=08, 09).
6. Compatible with BN 7200, 3300, 3300XL, and MX2030, MX8030 probes only.
7. Compatible with 3000 series probes only.
8. ETL, ATEX and IECEx hazardous area approvals.
9. Can be used with the MX2030 and MX8030 TightView Probe System.
10. Used to prevent cross talk when paired with an option BB=09 DPS (Shaft diameters <1.5 inches (37.5 mm)).



MX2034-AA-BB-CC-DD-EE-FFF-GG (DPS 4-20 MA TRANSMITTER)												
A	A	Material Calibration <sup>1,3</sup>	C	C	System Length <sup>13</sup>	F	F	F	Full Scale Range <sup>8</sup>			
0	1	AISI-SAE 4140 CrMo Steel <sup>1</sup>	0	5	5 meter <sup>4,9</sup>	0	0	8	30 mils, pk-pk (Vibration)			
0	2	17-4 Stainless Steel	0	7	7 meter <sup>5</sup>	0	0	9	40 mils, pk-pk (Vibration)			
0	3	Incoloy 901	0	9	9 meter <sup>6,9</sup>	0	2	1	100 μm, pk-pk (Vibration)			
0	4	K500 Monel	1	2	12 meter <sup>11</sup>	0	2	2	150 μm, pk-pk (Vibration)			
0	5	Inconel 625	1	5	15 feet <sup>7</sup>	0	2	3	200 μm, pk-pk (Vibration)			
0	6	410 Stainless Steel	2	0	20 feet <sup>7</sup>	0	2	4	250 μm, pk-pk (Vibration)			
0	7	316 Stainless Steel	<b>D D Approvals<sup>14</sup></b>			0	2	5	300 μm, pk-pk (Vibration)			
0	8	AISI-SAE 1040/1045 Carbon Steel	0	0	None	0	2	6	400 μm, pk-pk (Vibration)			
0	9	416 Stainless Steel	0	5	Multiple Approvals (No Dynamic Signal)	0	2	7	500 μm, pk-pk (Vibration)			
1	0	42CrMo4	0	6	Custom Union & KOSHA Approval (No Dynamic Signal)	0	2	8	750 μm, pk-pk (Vibration)			
1	1	18CrNiMo7-6	0	7	Multiple Approvals (Dynamic Signal)	0	2	9	1000 μm, pk-pk (Vibration)			
1	2	31CrMoV9	0	8	Custom Union & KOSHA Approval (Dynamic Signal)	0	5	0	30-70 mils, avg gap (Position)			
1	3	ST52-3	<b>E E Measurements</b>			0	5	1	20-80 mils, avg gap (Position)			
X	X	Other materials see page 11	0	1	Vibration - 2 wire	0	5	2	10-90 mils, avg gap (Position)			
<b>B B Probe Type</b>			0	2	Position - 2 wire	0	5	3	10-50 mils, avg gap (Position)			
0	1	5mm & 8mm – Metrix MX2030/BN 3300/BN3300XL	0	3	Speed - 2 wire	0	5	4	20-70 mils, avg gap (Position)			
0	2	5mm & 8mm – Metrix 7200/BN 7200	0	4	Vibration - 4 wire <sup>12</sup>	0	5	5	10-60 mils, avg gap (Position)			
0	3	0.190" – Metrix 3000/BN 3000	0	5	Position - 4 wire <sup>12</sup>	0	5	7	20-160 mils, avg gap (Position)			
0	4	0.300" – Metrix 3000/BN 3000	0	6	Speed - 4 wire <sup>12</sup>	0	5	8	20-180 mils, avg gap (Position)			
0	5	BN NSv and RAM	<b>F F F Full Scale Range<sup>8</sup></b>			0	7	0	750-1750 μm, avg gap (Position)			
0	6	11mm Metrix 7200 (CC option 05 and 09 only)	0	0	1	3 mils, pk-pk (Vibration)	0	7	1	500-2000 μm, avg gap (Position)		
0	7	11mm BN 3300XL (CC option 05 and 09 only)	0	0	2	4 mils, pk-pk (Vibration)	0	7	2	250-2250 μm, avg gap (Position)		
0	8	5mm & 8mm – MX8030/ BN 3300/ BN3300XL	0	0	3	5 mils, pk-pk (Vibration)	0	7	3	250-1250 μm, avg gap (Position)		
0	9	8mm – TightView MX8030 <sup>10</sup>	0	0	4	6 mils, pk-pk (Vibration)	0	7	4	500-1750 μm, avg gap (Position)		
1	0	5mm – TightView MX2030 <sup>10</sup>	0	0	5	10 mils, pk-pk (Vibration)	0	7	5	250-1500 μm, avg gap (Position)		
1	8	8mm – Extended Range MX8030 (CC Option 05 and 09 only, FFF Option 057, 058, 077, and 078)	0	0	6	15 mils, pk-pk (Vibration)	0	7	7	500-4000 μm, avg gap (Position)		
			0	0	7	20 mils, pk-pk (Vibration)	0	7	8	500-4500 μm, avg gap (Position)		
<b>For Speed Options Go To Next Page</b>												

NOTES:

1. AISI-SAE 4140 chromium molybdenum steel is the standard default calibration per API Standard 670. If no material type is specified at time of ordering, a factory-standard AISI 4140 target will be used. Calibration to target materials other than 4140 may restrict linear range and other specifications; consult the factory.
2. Due to the electrical properties of this material, vibration measurement accuracy may be affected when using this target.
3. Calibration to other material types is available upon request. Metrix will normally request that the customer supply a suitable sample of the material, allowing production of a machined target with appropriate surface finish.
4. Compatible with 7200, 3300, 3300XL, NSv, MX2030 and MX8030 probes only.
5. Compatible with BN NSv and RAM probes (BB=05), MX2030 (BB=01, 10), MX8030 (BB=08, 09).
6. Compatible with 7200, 3300, 3300XL, MX2030 and MX8030 probes only.
7. Compatible with 3000 series probes only.
8. Refer to Page 8 - 10 for probe (BB), measurement (EE), and full scale range (FFF) compatibility details.
9. Can be used with the MX2030 and MX8030 Tight View Probe System.
10. Used to prevent cross talk when paired with an option BB=09 DPS (Shaft diameters <1.5 inches (37.5 mm)).
11. Compatible with MX8030 and MX2030 probes only.
12. Two wires are for the 4-20 mA loop power and two wires are for the Dynamic Signal Output (raw signal).
13. Systems up to 12 meters available for vibration. Systems up to 20 meters available for thrust and speed. For system lengths other than listed contact factory.
14. For a SIL rating replace the first digit in the DD option with an S.

HOW TO ORDER MX2034

MX2034-AA-BB-CC-DD-EE-FFF-GG (DPS 4-20 MA TRANSMITTER)

F	F	F	Full Scale Range <sup>8</sup> (Continued)
5	0	1	500 RPM (Speed)
2	0	2	2000 RPM (Speed)
3	6	2	3600 RPM (Speed)
4	0	2	4000 RPM (Speed)
5	0	2	5000 RPM (Speed)
6	0	2	6000 RPM (Speed)
7	5	2	7500 RPM (Speed)
1	0	3	10000 RPM (Speed)
1	5	3	15000 RPM (Speed)
5	0	3	50000 RPM (Speed)
6	0	3	60000 RPM (Speed)
7	5	3	75000 RPM (Speed)
1	0	4	100000 RPM (Speed)
2	5	4	250000 RPM (Speed)
4	0	4	400000 RPM (Speed)

G	G	Pulses / Revolution
0	0	N/A (for vibration or position)
X	X	XX= number of pulses per revolution (keyways), valid entries are two digit numbers from 01-99, with a maximum value of RPM x # Keyways ≤ 400,000

Both the MX2033 driver and MX2034 transmitter has the ability to remove cross talk. The ability to change the frequency of the Oscillator Demodulator is enabled in the DPS Software by selecting Cross Talk Elimination. Using the MX2034 transmitter one can take manual control of the threshold and hysteresis settings to improve speed measurement performance. See DPS Installation Manual for more information.

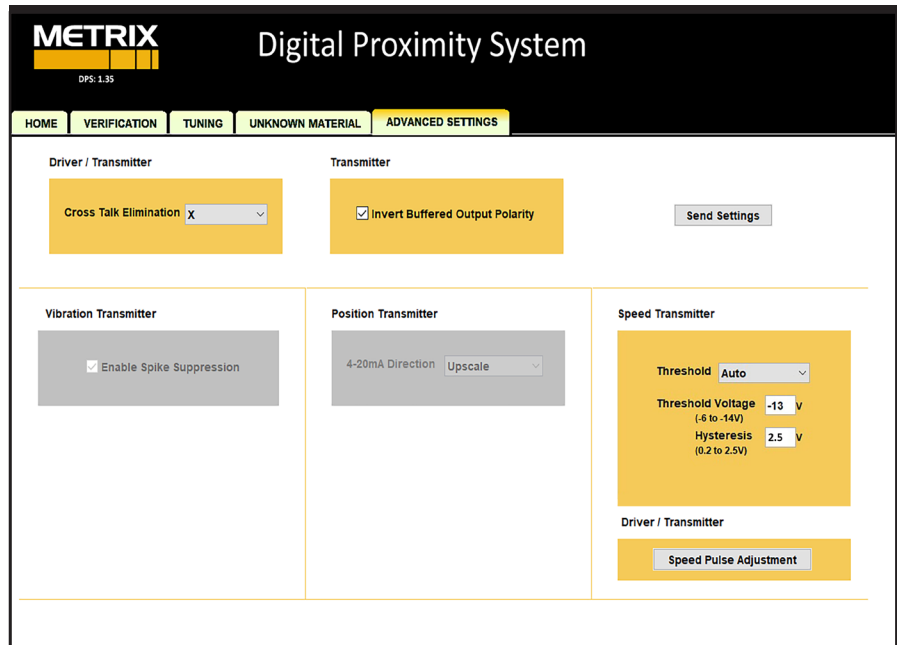

If the pulse height from the MX2033 Driver is not large enough for the Monitoring System to provide a reliable speed indication, or the MX2034 Transmitter is not providing a large enough pulse to have a reliable 4-20 mA speed output, then take advantage of the "Speed Pulse Adjustment" in the DPS Software "Advanced Features" tab. See DPS Installation Manual for more information.

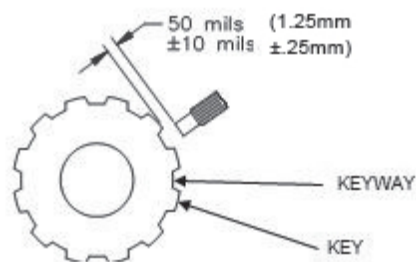



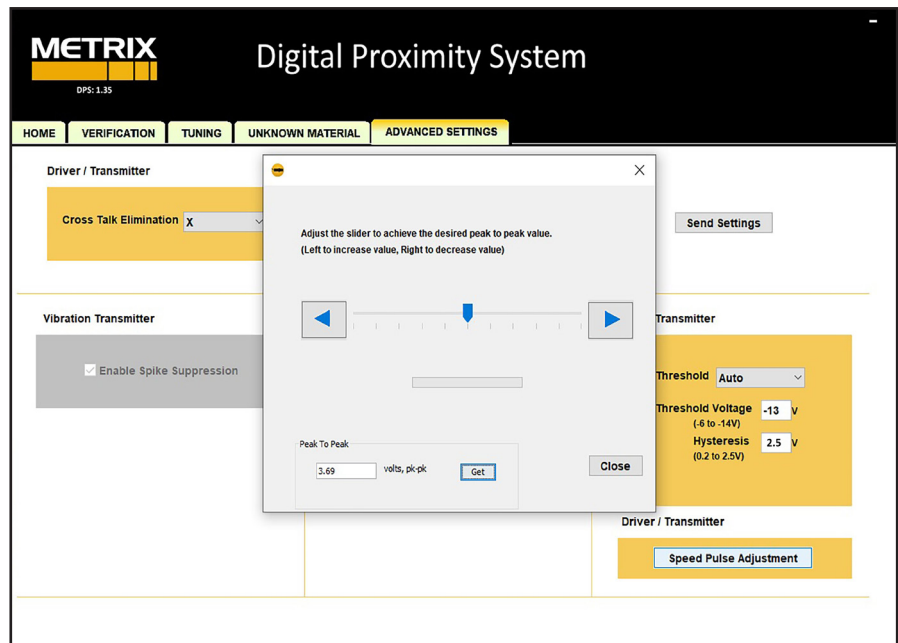













The minimum keyway width and key width is the diameter of the probe. The keyway depth should be a minimum of 1250 um (50mils) with a preferred depth of 2500 um (100 mils)





HAZARDOUS AREA APPROVALS

AREA	PROBE/CABLE	DRIVER/TRANSMITTER
North America	Class I, Div 1, Grps A,B,C,D -40°C to +177°C Intrinsically Safe and Non-Incendive	Class I, Div 1, Grps A,B,C,D, T4 -40°C ≤Ta≤ +85°C Intrinsically Safe 
		Class I, Div 2, Grps A,B,C,D, T4 -40°C ≤Ta≤ +85°C Non-Incendive 
International ATEX/IECEX KOSHA/Custom Union	 II 1G Ex ia IIC T3 Ga -40°C ≤Ta≤ +177°C	 II 1G Ex ia IIC T4 Ga -40°C ≤Ta≤ +85°C
	 II 1G Ex ia IIC T4 Ga -40°C ≤Ta≤ +110°C Intrinsically Safe	 17-AV4BO-0223  0Ex ia IIC T3/T4 Ga X Intrinsically Safe
   	 II 3G Ex nA IIC T3 Gc -40°C ≤Ta≤ +177°C	 II 3G Ex nA/ec IIC T4 Gc -40°C ≤Ta≤ +85°C
	 II 3G Ex nA IIC T4 Gc -40°C ≤Ta≤ +110°C Non-Incendive or Increased Safety	 17-AV4BO-0224  2Ex nA IIC T3/T4 Gc X Non-Incendive or Increased Safety

All Metrix proximity probes and cables fall under the 10,000 series.

SAFETY INTEGRITY LEVEL

SIL is a method or measurement unit to determine the reliability of electrical, electronic and programmable systems.

The purpose of the SIL certification is to measure safety system performance and the likelihood of failure. Achieving SIL certification, based on the IEC61508 Functional Safety Standard, signifies that the product has been thoroughly assessed and is a reliable electronic device ready to use across a wide range of industries.

Metrix DPS products have been thoroughly evaluated by an independent third party agency on the basis of IEC61508 Functional Safety standards to obtain SIL certification.

Table 1 - MX2034 Compatibility Probe Type vs. Measurement Range

Measurement Type	Full Scale Range	5mm & 8mm - MX8030/MX2030/ BN2300/3300XL, 8mm - MX8030 Tight View Probe Syst. 5mm - MX2030 Tight View Probe Syst 5mm & 8mm - MX7200/BN7200 0.190" - MX3000/BN3000 0.300" - MX3000/BN3000 5.26mm - BN NSV & RAM 11mm - MX7200/BN7200, 11mm - BN2300XL, 8mm - MX8030 Extended Range					
		BB=01, 08, 09, 10	BB=02	BB=03	BB=04	BB=05	BB=06, 07, 18
EE=01 (Vibration)	FFF=001 3 mils, pk-pk	YES	YES	YES	YES	YES	NO
	FFF=002 4 mils, pk-pk						
	FFF=003 5 mils, pk-pk						
	FFF=004 6 mils, pk-pk						
	FFF=005 10 mils, pk-pk						
	FFF=006 15 mils, pk-pk						
	FFF=007 20 mils, pk-pk						
	FFF=008 30 mils, pk-pk						
	FFF=009 40 mils, pk-pk						
	FFF=021 100 μm, pk-pk						
	FFF=022 150 μm, pk-pk						
	FFF=023 200 μm, pk-pk						
	FFF=024 250 μm, pk-pk						
	FFF=025 300 μm, pk-pk						
	FFF=026 400 μm, pk-pk						
	FFF=027 500 μm, pk-pk						
	FFF=028 750 μm, pk-pk						
FFF=029 1000 μm, pk-pk							

**Table 1 - MX2034 Compatibility  
Probe Type vs. Measurement Range**

		5mm & 8mm - MX8030/MX2030/ BN3300/33300XL, 8mm - MX8030 Tight View Probe Syst., 5mm - MX2030 Tight View Probe Syst. 5mm & 8mm - MX7200/BN7200 0.190" - MX3000/BN3000 0.300" - MX3000/BN3000 5.26mm - BN Vsv & rAM 11mm - MX7200/BN7200, 11mm - BN3300XL, 8mm - MX8030 Extended Range						
Measurement Type	Full Scale Range	BB=01, 08, 09, 10	BB=02	BB=03	BB=04	BB=05	BB=06, 07, 18	
EE=02 (Position)	FFF=050 30-70 mils, avg gap	YES	YES	NO	YES	YES	NO	
	FFF=051 20-80 mils, avg gap			NO	NO	NO		
	FFF=052 10-90 mils, avg gap			YES	YES	YES		
	FFF=053 10-50 mils, avg gap			NO	YES	NO		
	FFF=054 20-70 mils, avg gap			YES	YES	YES		
	FFF=055 10-60 mils, avg gap			NO	NO	NO		
	FFF=057 20-160 mils, avg gap	NO	NO	NO	NO	NO	YES	
	FFF=058 20-180 mils, avg gap							
EE=02 (Position)	FFF=070 750-1750 μm, avg gap	YES	YES	NO	YES	NO	NO	
	FFF=071 500-2000 μm, avg gap			NO	NO	NO		
	FFF=072 250-2250 μm, avg gap			YES	YES	YES		
	FFF=073 250-1250 μm, avg gap			NO	YES	NO		
	FFF=074 500-1750 μm, avg gap			YES	YES	YES		
	FFF=075 250-1500 μm, avg gap			NO	NO	NO		NO
	FFF=077 500-4000 μm, avg gap	NO	NO	NO	NO	NO	NO	YES
	FFF=078 500-4500 μm, avg gap							
EE = 03 (Speed)	FFF=501 500 RPM	YES	YES	YES	YES	YES	YES	
	FFF=202 2000 RPM							
	FFF=362 3600 RPM							
	FFF=402 4000 RPM							
	FFF=502 5000 RPM							
	FFF=602 6000 RPM							
	FFF=752 7500 RPM							
	FFF=103 10000 RPM							
	FFF=153 15000 RPM							
	FFF=503 50000 RPM							
	FFF=603 60000 RPM							
	FFF=753 75000 RPM							
	FFF=104 100000 RPM							
	FFF=254 250000RPM							
	FFF=404 400000 RPM							

Figure 2: Dimensions in inches [mm] for MX2034 digital proximity transmitter  
 Note: optional 4-hole baseplate mounting adapter shown (P/N 9647). 35mm din rail mount is standard.

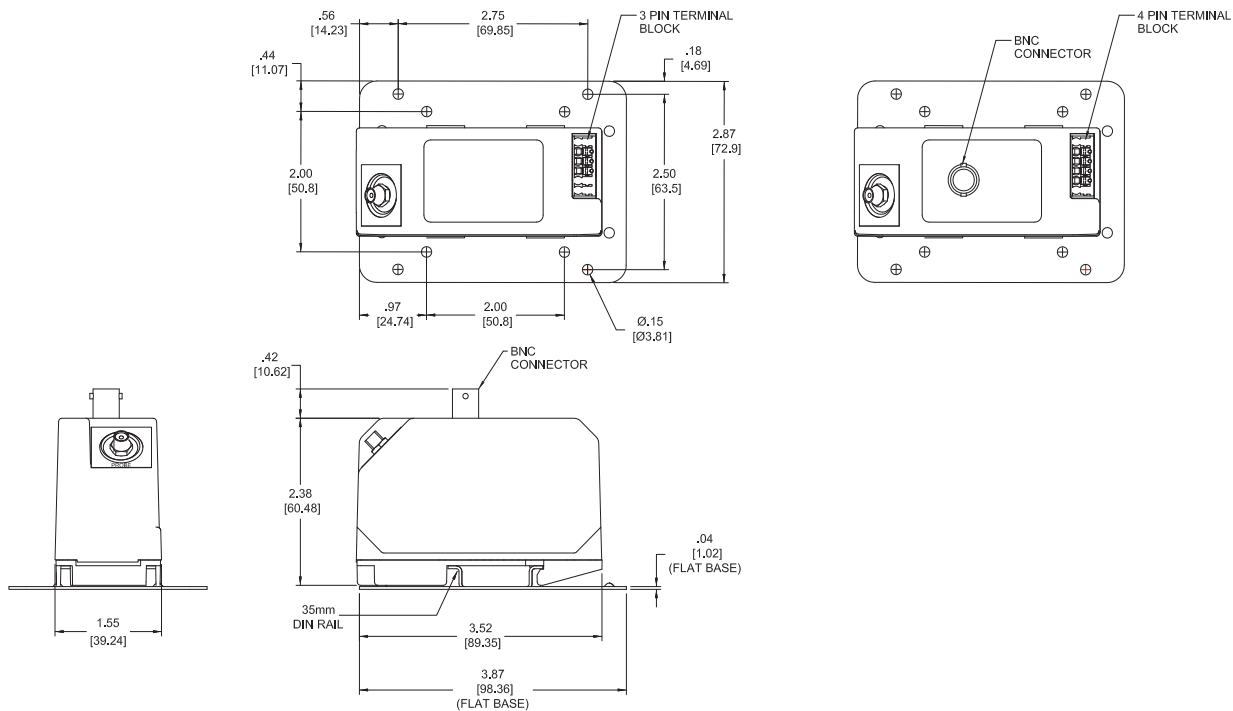

**MX2033 & MX2034-AA Options (Continued from page 6 or 7):**

A	A	Material Calibration
1	4	F6NM
1	5	7075-T6 Aluminum
1	6	Aluminized Steel
1	7	AISI-SAE 1018 Steel
1	8	15CrNi6
1	9	Tungsten Carbide
2	0	304 Stainless Steel
2	1	AISI-SAE 4320 Steel
2	2	AISI-SAE 4340 Steel
2	3	420 Stainless Steel
2	4	40NiCrMo7
2	5	6061-T6 Aluminium
2	6	UNS S32760, SUPER DUPLEX ALLOY
2	7	28CrMoNiV4-9
2	8	12CrNi4 Nickel Chromium Steel
2	9	QT600-3
3	0	BS 970: 1991 709M40T (SAME AS 5140)
3	1	AISI-SAE E9310 STEEL; BS 58E
3	2	UNS S31803, DUPLEX STAINLESS STEEL

**MX2033 & MX2034-AA Options (Continued from page 6 or 7):**

A	A	Material Calibration
3	3	15-5 Stainless Steel
3	4	Nickel Coating 1.0mm over 17-4
3	5	Tungsten Carbide coating 0.4mm over 17-4PH
3	6	Tungsten Carbide coating 0.4mm over 20Cr13
3	7	Tungsten Carbide coating 0.4mm over 42CrMoE
3	8	SUS403 Stainless Steel (AISE-SAE 403)
3	9	Tungsten Carbide coating 0.25mm over 17-4PH
4	0	Tungsten Carbide coating 0.29mm over 20Cr13
4	1	Tungsten Carbide coating 0.27mm over 42CrMoE
4	2	METCO 52
4	3	XM-19 (NITRONIC 50)
4	4	n/a
4	5	320 STAINLESS STEEL
4	6	X35CrMo17 / X39CrMo17-1
4	7	BS970 070M55
4	8	A276 Type S32760
4	9	15NiCr13

ACCESSORIES

DPS User Label Kit for up to 16 devices (P/N 100527)

Each MX2033 driver and MX2034 transmitter comes with the four factory-applied labels summarized below. The *DPS User Label Kit* allows the Left Sidewall Label to be replaced with a customized label containing installation-specific data, as depicted on page 3 of this datasheet. The User Label Kit contains enough materials for labeling up to 16 signal conditioners as follows:

- 16 specially-shaped polycarbonate adhesive labels with a clear rectangular window and the Metrix logo.
- A sheet of 32 standard 1.75" W x 1.25" H labels (Avery 6570).

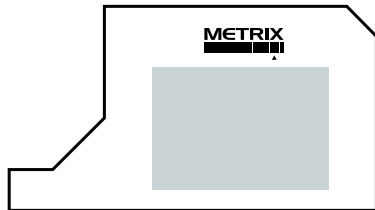

Using the Metrix DPS Configuration Software, the desired information is printed directly onto the Avery 6570 sheet using any Windows-compatible inkjet or laser printer. The printed Avery label is removed from the sheet, placed behind the window on the polycarbonate label, and both are then affixed to the left sidewall of the DPS signal conditioner. The polycarbonate label uses the same finish as all other factory-applied labels, providing protection from the elements and giving a clean, durable, and professional finish.

**NOTE:** The User Label Kit must be ordered separately and is not automatically included with driver or transmitter.

Of the four labels affixed to each DPS signal conditioner, only the Left Sidewall Label is intended for customization and field replacement. The others are designed to remain permanently affixed to the device during its life and contain information that does not change with device configuration.

1. Left Sidewall Label (*Configured Devices*)

All devices ordered in a configured state will have this label affixed. The label will reflect the as-ordered configuration data.

2. Right Sidewall Label

This is a factory-applied permanent label with the serial number, date of manufacture, model number and all approvals data.

3. Front Label

This is a factory-applied permanent label that indicates the connector for the probe and extension cable.

4. Top Label

This is a factory-applied permanent label that indicates the wiring terminals, model number, and (MX2034 only) BNC connection details. A machine tag label can be placed in an open space here.

\* Registered trademark(s) of Bently Nevada®.

DIN to 4-Hole Flat Base Mounting Adapter (P/N 9647)

This adapter allows the 35mm DIN rail clip on MX2033 driver, and MX2034 transmitters to be compatible with a 4-hole flat base mounting method. The adapter has industry-standard hole patterns for both a 2" x 2" square and a 2.75" x 2.5" rectangle. The 2" x 2" pattern matches the holes on Metrix 5533 drivers and BN\* 3300, 7200, and 3000 series Proximitors\* devices. The 2.75" x 2.5" pattern matches the holes on Metrix 5465/5488 transmitters and BN\* 990/991 transmitters. Material is 19 gauge mild steel (ASTM A366 or equal) with gold chromate zinc plating.

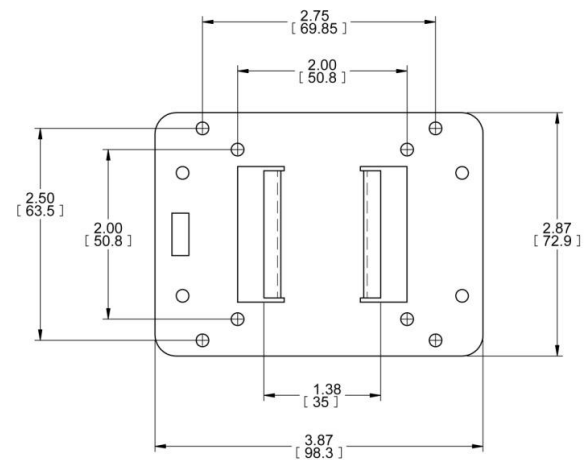
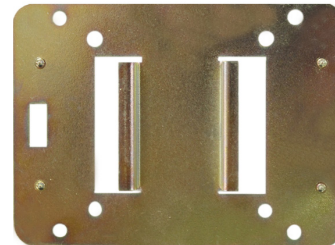

Dimensions are inch [mm]

MANUALS AND SOFTWARE

The most recent versions of the Metrix DPS Configuration Software and the DPS user manual can be downloaded from the Metrix website, [www.metrixvibration.com](http://www.metrixvibration.com).

**NOTE:** Manuals are published electronically in Adobe® PDF format and may be printed and freely distributed. Adobe Reader is required and can be downloaded free from [www.adobe.com](http://www.adobe.com).

**Note:** Metrix is continuously improving our products. Please refer to our website to download the latest version of this datasheet.

