

Trident Series PD765 Process & Temperature Meters

Instruction Manual



 **TRIDENT**



- 1/8 DIN Digital Panel Meter with NEMA 4X, IP65 Front
- 4-20 mA, ± 10 V, TC & RTD Field Selectable Inputs
- Easy Field Scaling in Engineering Units without Applying an Input
- Full 4-Digit Display, 0.56" (14.2 mm) or 1.20" (30.5 mm)
- Shallow Depth Case Extends Only 3.6" (91 mm) Behind Panel
- Isolated 24 VDC @ 200 mA Transmitter Power Supply Option (AC Powered Models Only)
- 2 Relays + Isolated 4-20 mA Output Options
- Free PC-Based MeterView Programming & Monitoring Software
- No Assembly Required
- Sunlight Readable Display
- Operating Temperature Range: -40 to 65°C (-40 to 149°F)
- UL & C-UL Listed. E160849; UL 508 Industrial Control Equipment
- Input Power Options: 85-265 VAC / 90-265 VDC or 12-36 VDC / 12-24 VAC
- Duplex Pump Controller with Alternation Capability
- External Contacts for Remote Button Operation (Trident X2 Only)
- USB, RS-232, & RS-485 Serial Communication Adapters Options
- Modbus RTU Communication Protocol Standard
- Copy Meter Settings to Other Trident Meters
- Password Protection
- Max/Min Display
- High & Low Alarms with Multiple Reset Actions
- Wide Assortment of NEMA 4X Enclosures for up to Ten Meters
- Light/Horn & Button Accessory for Trident X2
- Control Station Accessory for Remote Operation of Trident X2
- Stainless Steel Sun Hood Accessory Available
- 3-Year Warranty

PRECISION DIGITAL CORPORATION

233 South Street • Hopkinton MA 01748 USA
Tel (800) 343-1001 • (508) 655-7300

www.predig.com

**PRECISION
DIGITAL** 

Disclaimer

The information contained in this document is subject to change without notice. Precision Digital makes no representations or warranties with respect to the contents hereof and specifically disclaims any implied warranties of merchantability or fitness for a particular purpose. See Warranty Information and Terms & Conditions on www.predig.com for complete details.

CAUTION

- Read complete instructions prior to installation and operation of the meter.

WARNINGS

- Risk of electric shock or personal injury.
- This product is not recommended for life support applications or applications where malfunctioning could result in personal injury or property loss. Anyone using this product for such applications does so at his/her own risk. Precision Digital Corporation shall not be held liable for damages resulting from such improper use.

WARNING
Cancer and Reproductive Harm - www.P65Warnings.ca.gov

Limited Warranty

Precision Digital Corporation warrants this product against defects in material or workmanship for the specified period under "Specifications" from the date of shipment from the factory. Precision Digital's liability under this limited warranty shall not exceed the purchase value, repair, or replacement of the defective unit. See Warranty Information and Terms & Conditions on www.predig.com for complete details.

Registered Trademarks

All trademarks mentioned in this document are the property of their respective owners.

© 2024 Precision Digital Corporation.
All rights reserved.



FREE MeterView Programming Software



Note: Trident meter is not powered from USB connection and requires external power to be programmed.

The easiest and quickest way to program your Trident meter is to use the FREE MeterView software. We will even send you a PDA8006 USB adapter, normally sold for \$47.00, at no cost if you register your meter at www.predig.com/free8006 (limit one per customer). You can program the Trident meter you just bought with the front panel buttons and have the PDA8006 on hand for programming future meters.

MeterView software is intuitive, and most customers can get their meter programmed as they like without even looking in the manual.

Watch MeterView Software Video at
<https://www.predig.com/meterview>

In addition to programming, the software, with additional devices, may be used for:

- Monitoring up to 100 Trident meters
- Datalogging using your PC
- Generating and saving programming files for later use

Once your meter is programmed the way you want it, you can wire it up for your application per the instructions in this manual and install it. If you find that you need to make adjustments to the programming after the meter is installed, you can use the front panel buttons and the instructions in this manual to do so.

Table of Contents

Introduction.....	6
Ordering Information.....	6
Specifications	8
General	9
Process Input.....	9
Temperature Inputs	9
Relays Option.....	10
Serial Communications	10
Isolated 4-20 mA Transmitter Output.....	10
External Button Contacts (X2 Models Only).....	10
MOD-LH Light/Horn	10
Compliance Information.....	11
Safety	11
Electromagnetic Compatibility	11
EU Declaration of Conformity.....	12
Safety Information	12
Installation.....	13
Unpacking	13
Panel Mounting.....	13
Mounting Dimensions	13
Connections	14
Connector Labeling	14
Power Connections	16
Signal Connections	16
Serial Communication	17
Relays and 24 V Output Connections	18
Switching Inductive Loads.....	18
4-20 mA Output & Input Signal Connections.....	19
Isolated 4-20 mA Signal Splitters & Converters.....	20
Isolated 4-20 mA Signal Splitter	20
4-20 mA to 0-10 VDC Signal Converter.....	20
External Button Contacts on Trident X2.....	20
Four-Position Control Station for Remote Operation of Trident PD765 X2 Buttons.....	20
Setup and Programming.....	21
Overview.....	21
Front Panel Buttons and Status LED Indicators	21
Display Functions and Messages	22
Main Menu	23
Setting Numeric Values.....	23
Setting Up the Meter (SEtU).....	23
Setting the Input Signal (iNPT)	23
Setting the Decimal Point (dcPt).....	24
Setting the Temperature Scale (F °C).....	24
Programming the Meter (PrOg)	24
Scaling the Meter (ScAL)	24
Calibrating the Meter (CAL).....	25
Recalibrating Temperature Inputs (CAL)	25
Recalibrating Process Inputs (iCAL).....	25
Setting the Relay Operation (rELy)	26
Relay and Alarm Operation	27
Scaling the 4-20 mA Analog Output (RAUt).....	31
Isolated 4-20 mA Signal Splitters & Converters.....	31
Program the Sensor Break Output Value (SEbr).....	31
Analog Output when Display is Out of Range	31

- Setting Up the Password (PASS) 32**
 - Locking the Meter 32
 - Unlocking the Meter 32
- Advanced Features Menu 32**
 - Advanced Features Menu & Display Messages 32
 - Offset Adjustment (Adj) 33
 - Noise Filter (FLtr) 33
 - Noise Filter Bypass (bYP5) 33
 - Serial Communications (SERL) 34
 - Protocol Selection Menu (Prot) 34
 - Select Menu (SELC) 34
 - Linear or Square Root Function (Linr or SqRt) 34
 - Low-Flow Cutoff (cutf) 34
 - Display Intensity (int5) 35
 - Meter Copy Function (cOPY) 35
- MeterView Software 36**
 - Remote Programming 36
 - Data Acquisition 36
 - Monitoring 36
 - Monitoring System Parts..... 36
 - MeterView Installation 36
 - Running MeterView the First Time 36
 - Enable Meter and Select Meter Address 36
 - MeterView Main Window 37
 - Main Window Menus 37
 - Configuration Window..... 38**
 - File Menu..... 38
 - Tools Menu..... 38
 - Password Menu..... 39
 - Input Tab 39
 - Set Up Input Type 39
 - Set Up Decimal Point 39
 - Set Up Temperature Unit..... 39
 - Set Up Temperature Sensor..... 39
 - Scaling Tab 40
 - Relays/Alarms Tab 40
 - Advanced Tab 40
 - Info Tab 40
 - Customize Window 40
 - Serial Communication Setup 41
 - Relays/Alarms Status 41
 - Logging Meter Data to File..... 41
 - Log File Sample 41
 - Internal Calibration (ICPL) 42
- Operation..... 43**
 - Front Panel Buttons Operation..... 43
 - Maximum/Minimum Readings 43
 - Remote Operation of Trident X2 Front Panel Buttons..... 43
- Troubleshooting 44**
 - Diagnostics Menu (dRG)..... 44**
 - Determining Software Version 44
 - Reset Meter to Factory Defaults 44
 - Factory Defaults & User Settings 45
 - Troubleshooting Tips 46
- Quick Interface Reference Guide 47**

Table of Figures

Figure 1. Panel Cutout and Mounting	13
Figure 2. Meter Dimensions – Side View	13
Figure 3. Case Dimensions – Top View	13
Figure 4. Connector Labeling for PD765-#R0-00	14
Figure 5. Connector Labeling for PD765-6R0-10	14
Figure 6. Connector Labeling for PD765-#R2-00	14
Figure 7. Connector Labeling for PD765-6R2-10	14
Figure 8. Connector Labeling for PD765-#R3-00	14
Figure 9. Connector Labeling for PD765-6R3-10	14
Figure 10. Connector Labeling for PD765-6R3-20	14
Figure 11. Connector Labeling for PD765-7R5-00	15
Figure 12. Connector Labeling for PD765-6R5-10	15
Figure 13. Connector Labeling for PD765-#X0-00.....	15
Figure 14. Connector Labeling for PD765-6X0-10.....	15
Figure 15. Connector Labeling for PD765-#X2-00.....	15
Figure 16. Connector Labeling for PD765-6X2-10.....	15
Figure 17. Connector Labeling for PD765-#X3-00.....	15
Figure 18. Connector Labeling for PD765-6X3-10.....	15
Figure 19. Connector Labeling for PD765-6X3-20.....	16
Figure 20. Connector Labeling for PD765-7X5-00.....	16
Figure 21. Connector Labeling for PD765-6X5-10.....	16
Figure 22. Power Connections	16
Figure 23. Transmitter Powered by Internal Supply (Optional)	16
Figure 24. Transmitter Powered by External Supply or Self-Powered.....	16
Figure 25. Voltage Input Connections	16
Figure 26. Thermocouple Input Connections.....	17
Figure 27. Three-Wire RTD Input Connections	17
Figure 28. Two-Wire RTD Input Connections.....	17
Figure 29. Four-Wire RTD Input Connections	17
Figure 30. Relay & 24 V Output Connections.....	18
Figure 31. AC and DC Loads Protection.....	18
Figure 32. Low Voltage DC Loads Protection	18
Figure 33. 4-20 mA Output & Input Signal Powered by Meter	19
Figure 34. 4-20 mA Output Powered by Meter	19
Figure 35. 4-20 mA Output Powered Externally	19
Figure 36. Trident X2 Powers Both the Heater and 4-20 mA Input Signal	19
Figure 37. Passive 4-20 mA Output from Trident Meter Split into Two Isolated 4-20 mA Signals	20
Figure 38. Passive 4-20 mA Output from Trident Meter Converted to 0-10 VDC Signal	20
Figure 39. Meter Copy Connection	35

Introduction

The PD765 Trident digital panel meter is one of the most versatile digital panel meters on the market and will satisfy a wide variety of process and temperature applications. The Trident can be field programmed to accept process voltage (0-5V, 1-5V, etc) and current (4-20 mA) inputs, 100 Ohm RTDs, and the four most common thermocouple types.

One of the most useful features of the Trident PD765 when it is AC powered is its ability to provide 24 VDC to power the transmitter's 4-20 mA signal. This reduces costs and simplifies wiring. The Trident is housed in a shallow-depth, 1/8 DIN enclosure that features a NEMA 4X front panel and convenient mounting hardware. There are two power options for the Trident: 85 to 265 VAC or 12-36 VDC and certain configurations of the AC powered meter can provide 24 VDC to power the transmitter, if needed.

Programming and setup can be performed with the four front panel pushbuttons, free MeterView software, or using the Copy function.

Two relays and isolated 4-20 mA output options increase the utility of the Trident meter. The relays can be used for alarm or control applications. The 4-20 mA output provides an isolated retransmission of the input signal; especially useful for temperature inputs like thermocouples and RTDs.

The display height on the standard Trident meter is 0.56" (14.2 mm) and on the Trident X2 the display height is an astounding 1.2" (30.5 mm). The Trident X2 can be read easily from distances of up to 30 feet!

The intensity of the display on both versions of the Trident can be adjusted to compensate for various lighting conditions, especially direct sunlight.

Ordering Information

Trident

85-265 VAC Model	12-36 VDC Model	Options Installed
PD765-6R0-00	PD765-7R0-00	No options
PD765-6R0-10		24 V supply
PD765-6R2-00	PD765-7R2-00	2 relays
PD765-6R2-10		2 relays 24 V supply
PD765-6R3-00	PD765-7R3-00	4-20 mA output
PD765-6R3-10		4-20 mA output 24 V supply
PD765-6R3-20		4-20 mA output dual 24 V supplies
	PD765-7R5-00	2 relays 4-20 mA output
PD765-6R5-10		2 relays 4-20 mA output 24 V supply

Trident X2

85-265 VAC Model	12-36 VDC Model	Options Installed
PD765-6X0-00	PD765-7X0-00	No options
PD765-6X0-10		24 V supply
PD765-6X2-00	PD765-7X2-00	2 relays
PD765-6X2-10		2 relays 24 V supply
PD765-6X3-00	PD765-7X3-00	4-20 mA output
PD765-6X3-10		4-20 mA output 24 V supply
PD765-6X3-20		4-20 mA output dual 24 V supplies
	PD765-7X5-00	2 relays 4-20 mA output
PD765-6X5-10		2 relays 4-20 mA output 24 V supply

Accessories

Model	Description
PDA1024-01	24 VDC Power Supply for DIN Rail
PDA18DINSH	Stainless Steel Sun Hood
PDA7420	Trident Meter Copy Cable, 7' (2.1 m)
PDA7422	Trident RS-485 Serial Adapter
PDA7232	Trident RS-232 Serial Adapter
PDA7485-I	RS-232 to RS-485 Isolated Converter
PDA8006	USB Serial Adapter for Programming Meter with MeterView Software*
PDA8232-N	USB to RS-232 Non-Isolated Converter
PDA8485-I	USB to RS-485 Isolated Converter
MOD-LH	Light/Horn / Enclosure Modification
PD659	Signal Isolators, Splitters, & Conditioners
PDA2360	Plastic Control Stations
PD9501	Multi-Function Calibrator
PD9502	Low-Cost Signal Generator
PDX6901	Snubber: 0.01 µF/470 Ω, 250 VAC

*See [Free 8006](#) to receive PDA8006 at no charge.

Light/Horn Accessories for Trident X2



Model	Description
MOD-LHRB1	Red Light/Horn and Button with Holes Drilled in Enclosure ⁽¹⁾
MOD-LHGB1	Green Light/Horn and Button with Holes Drilled in Enclosure ⁽¹⁾
MOD-LHYB1	Yellow Light/Horn and Button with Holes Drilled in Enclosure ⁽¹⁾
MOD-LHBB1	Blue Light/Horn and Button with Holes Drilled in Enclosure ⁽¹⁾
MOD-LHWB1	White Light/Horn and Button with Holes Drilled in Enclosure ⁽¹⁾
MOD-LH5CB1	Light/Horn with User Choice of Red, Green, Yellow, Blue or White Light, Button, and Holes Drilled in Enclosure ⁽¹⁾
PDA-BUTTON1R	Red Button
PDA-BUTTON1G	Green Button
PDA-BUTTON1B	Blue Button
PDA-LHR	Red Light/Horn
PDA-LHG	Green Light/Horn
PDA-LHY	Yellow Light/Horn
PDA-LHB	Blue Light/Horn
PDA-LHW	White Light/Horn
PDA-LHW	White Light/Horn
PDA-LH5C	Light/Horn with User Choice of Red, Green, Yellow, Blue or White Light

Note:

- The enclosure comes pre-drilled with holes for Light/Horn and Button to be installed by user. Meter / controller and enclosure are sold separately. The Light/Horn hole is located on the top in the back left corner of the enclosure and the button hole is centered on the front of the enclosure about an inch off the bottom of the door. For mounting in different locations, order items separately and drill holes and mount as desired.

PDA2360 Control Stations for Trident X2



Model	Description
PDA2360-E	Emergency Stop Button
PDA2361-A	1 Black Ack Button
PDA2361-Q	1 Black Silence Button
PDA2364-MRUE	4 Black Buttons: Menu, Right, Up, Enter

Signal Splitter & Conditioner Accessories



Model	Description
PD659-1MA-1MA	Signal Isolator with One 4-20 mA Input and One 4-20 mA Output
PD659-1MA-2MA	Signal Splitter with One 4-20 mA Input and Two 4-20 mA Outputs
PD659-1V-1MA	Signal Conditioner with One 0-10 VDC Input and One 4-20 mA Output
PD659-1MA-1V	Signal Conditioner with One 4-20 mA Input and One 0-10 VDC Output

Enclosures

Series	Meters	Material
PDA2300	1-10	Plastic NEMA 4X
PDA2500	1-6	Plastic NEMA 4X
PDA2600	1-6	Stainless Steel NEMA 4X
PDA2700	1-6	Painted Steel NEMA 4
PDA2800	1-2	Plastic NEMA 4X
PDA3400	1-3	Plastic NEMA 4X

**Need help selecting the right enclosure?
Go to www.prediq.com/esu**

No More Sun Glare On Your Panel Meter Display!

NEW PDA18DINSH Sun Hood

The PDA18DINSH Sun Hood improves the readability of 1/8 DIN digital panel meters when they are mounted in direct sunlight by shading the instrument from the sun.

The Sun Hood is made from 18 gauge 316 stainless steel and mounts between the 1/8 DIN digital panel meter and the panel. In addition, a gasket is provided that installs between the Sun Hood and the panel to provide a NEMA 4X seal to the panel. The whole assembly is held in place by the panel meter's mounting brackets.

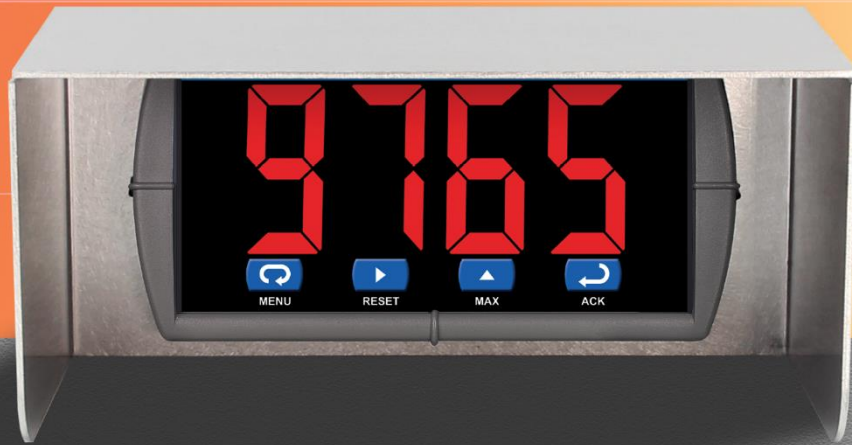
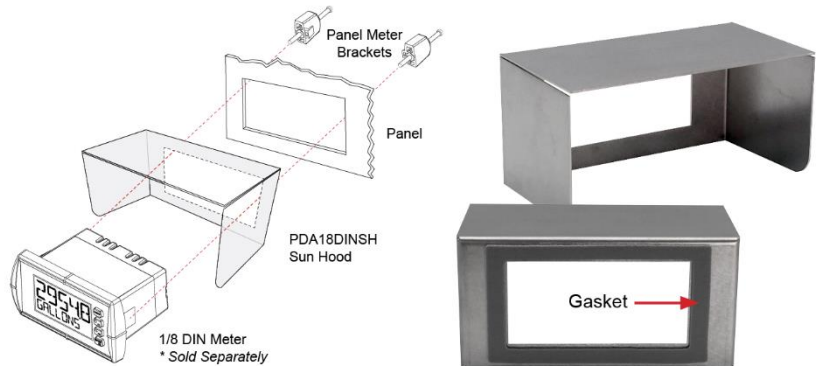

- Provides Shade for 1/8 DIN Digital Panel Meters
- Made from 18 Gauge 316 Stainless Steel
- Easy Mounting Requires no Drilled Holes in the Panel
- Includes Gasket to Maintain NEMA 4X Seal

SPECIFICATIONS

Model	PDA18DINSH
Material	18 gauge 316 stainless steel
Overall Dimensions	2.99" x 5.68" x 2.99" (H x W x D)
Weight	(75 mm x 144 mm x 75 mm)
Gasket Material	0.9 lb (0.4 kg)
	Silicone Foam

Visit predig.com/pda18dinsh for more information.

Specifications

Except where noted all specifications apply to operation at +25°C.

General

Display	Trident: 0.56" (14.2 mm); Trident X2: 1.20" (30.5 mm) red LED, 4 digits (-1999 to 9999)
Display Intensity	Eight user selectable levels. Default intensity is 6.
Front Panel	NEMA 4X, IP65; panel gasket provided
Programming Methods	Four front panel buttons, cloning with Copy feature, PC with MeterView software, and Modbus registers .
Noise Filter	Programmable from 2 to 199 (0 will disable filter)
Display Update Rate	Process/RTD: 3.7-5/second Thermocouple: 1.8-2.5/second
Overrange	Display flashes 9999
Underrange	Display flashes - 1999
Recalibration	All ranges are calibrated at the factory. Recalibration is recommended at least every 12 months.
Max/Min Display	Stored until reset by user or meter is turned off.
Password	Restricts modification of programmed settings.
Non-Volatile Memory	Settings stored for a minimum of 10 years.
Power Options	85-265 VAC, 50/60 Hz; 90-265 VDC, 20 W max or 12-36 VDC; 12-24 VAC, 6 W max.
Required Fuse	UL Recognized, 5 A max, slow-blow; up to 6 meters may share one fuse.
Normal Mode Rejection	64 dB at 50/60 Hz
Isolation	4 kV input/output-to-power line; 500 V input-to-output or output-to-24 VDC supplies. For -6R5 & -6X5 models only: 100 V output-to-24 VDC supply
Environmental	Operating temperature range: -40 to 65°C (-40 to 149°F) Storage temperature range: -40 to 85°C (-40 to 185°F) Relative humidity: 0 to 90% non-condensing
Connections	Power & Signal: removable screw terminal blocks accept 12 to 22 AWG. Serial: RJ11 header, standard on all meters.
Enclosure	1/8 DIN, high impact plastic, UL 94V-0, color: gray
Front Panel Mounting	NEMA 4X, IP65 1/8 DIN panel cutout required: 3.622" x 1.772" (92 mm x 45 mm) Two panel mounting bracket assemblies are provided.
Tightening Torque	Screw terminal connectors: 5 lb-in (0.56 Nm)
Overall Dimensions	4.68" x 2.45" x 4.19" (119 mm x 62 mm x 106 mm) (W x H x D)
Weight	9.5 oz. (269 g) (including options)
UL File Number	E160849; UL 508 Industrial Control Equipment
Warranty	3 years parts & labor. See Warranty Information and Terms & Conditions on www.prediq.com for complete details.

Process Input

Inputs	0-20 mA, 4-20 mA, 1-5 V, ±10 V	
Transmitter Supply	(AC Powered Models Only) Isolated, one or two transmitter supplies P1: 24 VDC ±10% @ 200 mA max (-10 option) P1 & P2: 24 VDC ±10% @ 200 mA & 40 mA max (-20 option)	
Accuracy	±0.05% FS ±1 count; ±0.1% FS ±2 counts for square root	
Function	Linear or square root	
Low-Flow Cutoff	0 to 9999 (0 disables cutoff function) Point below at which display always shows zero.	
Decimal Point	Up to 3 decimals.	
Calibration	Scale without signal or calibrate with signal source	
Calibration Range	User programmable over entire range of meter	
Input Impedance	Voltage range: greater than 1 MΩ, Current range: 50-100 Ω, varies with resettable fuse impedance	
Input Overload	Protected by automatically resettable fuse	
Temperature Drift	0 to 65°C ambient Current: ±0.20% FS (50 PPM/°C) Voltage: ±0.02% FS (1.7 PPM/°C)	-40 to 0°C ambient Current: ±0.80% FS Voltage: ±0.06% FS

Temperature Inputs

Inputs	Factory calibrated, field selectable: type J, K, T, or E thermocouples and 100 Ω platinum RTD (0.00385 or 0.00392 curve)
Resolution	1°; type T TC & RTD: 1° or 0.1°
Cold Junction Reference	Automatic
Temperature Drift	±2°C maximum
Offset Adjustment	Programmable to ±19.9°. This parameter allows the user to apply an offset value to the temperature being displayed.
Input Impedance	Greater than 100 kΩ

Accuracy

Input Type	Range	Accuracy (0 - 65 C)	Accuracy (-40 - 0 C)	Resolution
J	-58 to 1382°F -50 to 750°C	±2°F ±1°C	±5°F ±3°C	1°
K	-58 to 2300°F -50 to 1260°C	±2°F ±1°C	±4°F ±2°C	1°
T	-292 to 700°F -180 to 371°C	±2°F ±1°C	±13°F ±7°C	1° or 0.1°
E	-58 to 1700°F -50 to 927°C	±2°F ±1°C	±11°F ±6°C	1°
RTD	-328 to 1382°F -200 to 750°C	±1°F ±1°C	±5°F ±3°C	1° or 0.1°

Relays Option

Rating	2 Form C (SPDT); rated 3 A @ 30 VDC or 3 A @ 250 VAC resistive load; 1/14 HP (≈ 50 watts) @ 125/250 VAC for inductive loads such as contactors, solenoids, etc.
Deadband	0-100% FS, user selectable
Electrical Noise Suppression	A snubber should be connected to each relay contact switching inductive loads to prevent disruption to the microprocessor's operation. Recommended snubber value: 0.01 μF/470 Ω, 250 VAC (PDX6901).
High or Low Alarm	User may program any alarm for high or low
Relay Operation	<ul style="list-style-type: none"> Automatic (non-latching) and/or manual reset Latching (requires manual acknowledge) with/without clear Pump alternation control Off (disable unused relays)
Relay Reset	Front panel button, terminal at back of meter (X2 models only), or through serial communications
Time Delay	0 to 199 seconds, on and off delays; programmable
Sensor Break Relay Operation	The sensor break relay condition may be programmed for each relay as On (alarm) or Off (nonalarm). The relays will enter these states when a sensor break is detected for RTD or thermocouple inputs. These settings have no effect when current or voltage inputs are selected.
Fail-Safe Operation	Programmable, independent for each relay. Relay coils are energized in non-alarm condition. In case of power failure, relays will go to alarm state.
Auto Initialization	When power is applied to the meter, relays will reflect the state of the input to the meter.

Serial Communications

Compatibility	EIA-232, and EIA-485 with PDA7232 and PDA7422 Trident adapters.
Protocol	Modbus RTU
Meter Address	PDC protocol: 0 - 99 Modbus protocol: 1 - 247
Baud Rate	300 – 19,200 bps
Transmit Time Delay	Programmable 0 to 199 ms
Data	8 bit (1 start bit, 1 stop bit)
Parity	None (1 or 2 stop bits), even, or odd (Modbus only; PDC protocol does not use parity)
Turn Around Delay	Less than 2 ms (fixed)

Refer to PDC and Modbus Serial Communication Protocol manuals for details.

Isolated 4-20 mA Transmitter Output

Scaling Range	1.00 to 23.00 mA; reverse scaling allowed.		
Calibration	Factory calibrated for 4-20 mA		
Accuracy	±0.1% FS ±0.004 mA		
Temperature Drift	50 PPM/°C Note: Analog output drift is separate from input drift.		
Isolation	4 kV output-to-power line; 500 V input-to-output or output-to-24 VDC supplies. For -6R5 & -6X5 models only: 100 V output-to-24 VDC supply		
External Power	35 VDC maximum		
Output Loop Resistance	Power supply	Minimum	Maximum
	24 VDC	10 Ω	700 Ω
	35 VDC (external)	100 Ω	1200 Ω
Additional 4-20 mA Outputs	The PD659-1MA-2MA can split the optional 4-20 mA output into two isolated 4-20 mA outputs		
0-10 VDC Output	The PD659-1MA-1V can convert the optional 4-20 mA output to a 0-10 VDC signal		

PDA8006 Trident USB Adapter

Purpose	To be used only for programming the Trident meter
Compatibility	USB 1.1, USB 2.0
Connectors	RJ11, and USB Type B
Cable	One 7' (2.1 m) standard modular cable and one 3.28' (1.0 m) USB A-B Male cable provided with adapter
Dimension	1.7" x 0.8" x 3.3" 43 mm x 21 mm x 83 mm (W x H x D)
Distance	Adapter to: PD765/PD8-765 meter: 7' (2.1 m) max; USB connection to PC: 10' (3 m) max
Driver Compatibility	Microsoft® Windows® 7/10/11
Power	USB Port
Status Indication	Separate LEDs for Power (P), Transmit (TX), and Receive (RX)

External Button Contacts (X2 Models Only)

Number	Four
Function	Remote operation of front-panel buttons: programming, reset relays or view/reset max/min readings.
Open State	+5 VDC open contact on button input terminals
Closed State	Closed contact button input terminal to common/ground, active low 0 to 0.4 VDC

MOD-LH Light/Horn

Available for these Models	Trident X2 only		
Light Colors	MOD-LH Models: Red, green, yellow, blue or white. MOD-LH5CB1: User selectable: red, green, yellow, blue, or white.		
Light Action	Can be wired to flash (not available on MOD-LH5CB1) or stay steady on		
Light/Horn & Button Installation	When MOD-LH is ordered with an enclosure, the user performs installation and wiring of Light/Horn and Button in predrilled holes.		
Horn	85 dB		
Rating	IP65		
Light/Horn Independence	Light and horn can be controlled via separate relays		
Power Requirement	No additional power required when wired to a Trident X2 meter. When mounted remote: 24 VDC		
Transmitter Power Supply	The Trident X2's internal transmitter power supply is capable of supplying 24 VDC @ 200 mA to power the transmitter and other devices such as the Light/Horn. The following table illustrates how much of this current is required to drive various Light/Horns. If more current is needed, then consider the PDA1024-01.		
<i>MOD-LH and MOD-LH5CB1 Models:</i>			
Color	Current Required	Color	Current Required
Red	17 mA	Blue	15 mA
Green	15 mA	White	42 mA
Yellow	23 mA	Horn	20 mA
<i>Example: 17 mA (Red Light) + 20 mA (Horn) = 37 mA total current needed from the 200 mA supply. Available current = 163 mA</i>			
Reset / Silence Button	NEMA 4X; may be wired to the external button contacts on Trident X2. The Ack front panel button can be used to reset / acknowledge the relays.		
Button Labels	The Light/Horn accessory comes with 9 pre-printed message labels the user can affix under the red button: RESET, BATCH, ACK, TARE, SILENCE, STOP, START, PAUSE, START/STOP.		
Light/Horn Mounting Connection	M22		
Hole Sizes	Light/Horn: 0.875" (22 mm) Button: 0.630" (16 mm)		
Cable Length	3.28 feet (1 meter)		
Operating Temperature Range	-5 to 40°C (23 to 104°F)		

Compliance Information Safety

UL Listed	USA and Canada UL 508 Industrial Control Equipment
UL File Number	E160849
Front Panel	UL Type 4X, NEMA 4X, IP65; panel gasket provided
Low Voltage Directive	EN 61010-1 Safety requirements for measurement, control, and laboratory use

Electromagnetic Compatibility

Emissions	EN 55011 Group 1 Class A ISM emissions requirements
Radiated Emissions	Class A
AC Mains Conducted Emissions	Class A
Immunity	EN 61326-1 Measurement, control, and laboratory equipment EN 61000-6-2 EMC heavy industrial generic immunity standard
RFI - Amplitude Modulated	80 -1000 MHz 10 V/m 80% AM (1 kHz) 1.4 - 2.0 GHz 3 V/m 80% AM (1 kHz) 2.0 - 2.7 GHz 1 V/m 80% AM (1 kHz)
Electrical Fast Transients	±2kV AC mains, ±1kV other
Electrostatic Discharge	±4kV contact, ±8kV air
RFI - Conducted	10V, 0.15-80 MHz, 1kHz 80% AM
AC Surge	±2kV Common, ±1kV Differential
Surge	1KV (CM)
Power-Frequency Magnetic Field	30 A/m 70%V for 0.5 period
Voltage Dips	40%V for 5 & 50 periods 70%V for 25 periods
Voltage Interruptions	<5%V for 250 periods

Note:

Testing was conducted on meters installed through the covers of grounded metal enclosures with cable shields grounded at the point of entry representing installations designed to optimize EMC performance.

EU Declaration of Conformity

For shipments to the EU and UK, a Declaration of Conformity was printed and included with the product. For reference, a Declaration of Conformity is also available on our website www.predig.com/docs.

Safety Information

CAUTION

- Read complete instructions prior to installation and operation of the meter.

WARNINGS

- Risk of electric shock.
 - Hazardous voltages exist within enclosure.
 - Installation and service should be performed only by trained service personnel.
-

Installation

There is no need to remove the meter from its case to complete the installation, wiring, and setup of the meter.

Unpacking

Remove the meter from box. Inspect the packaging and contents for damage. Report damages, if any, to the carrier.

If any part is missing or the meter malfunctions, please contact your supplier or the factory for assistance.

Panel Mounting

- Prepare a standard 1/8 DIN panel cutout – 3.622" x 1.772" (92 mm x 45 mm). Refer to *Mounting Dimensions* for more details.
- Clearance: allow at least 4" (102 mm) behind the panel for wiring.
- Panel thickness: 0.04" - 0.25" (1.0 mm - 6.4 mm). Recommended minimum panel thickness to maintain Type 4X rating: 0.06" (1.5 mm) steel panel, 0.16" (4.1 mm) plastic panel.
- Remove the two mounting brackets provided with the meter (back-off the two screws so that there is ¼" (6.4 mm) or less through the bracket. Slide the bracket toward the front of the case and remove).
- Insert meter into the panel cutout.
- Install mounting brackets and tighten the screws against the panel. To achieve a proper seal, tighten the mounting bracket screws evenly until meter is snug to the panel along its short side. **DO NOT OVER TIGHTEN**, as the rear of the panel may be damaged.

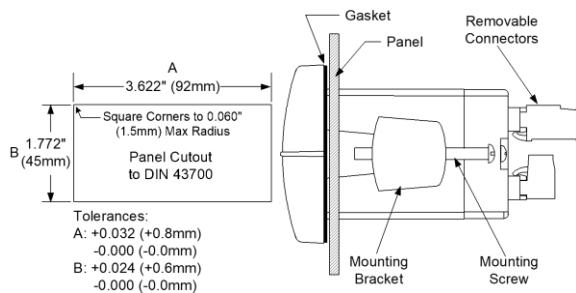

Figure 1. Panel Cutout and Mounting

Mounting Dimensions

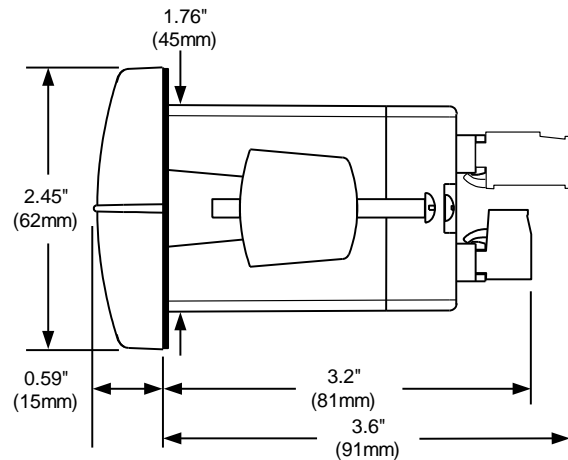

Figure 2. Meter Dimensions – Side View

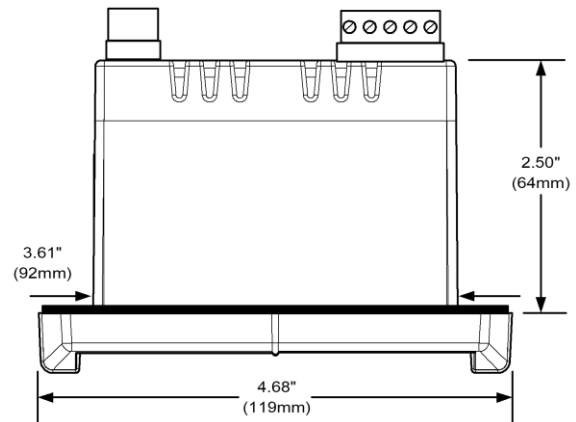

Figure 3. Case Dimensions – Top View



Download free 3-D CAD files of these instruments to simplify your drawings!

predig.com/documentation-cad

Connections

All connections are made to removable screw terminal connectors located at the rear of the meter.

CAUTION

- Use copper wire with 60°C or 60/75°C insulation for all line voltage connections. Observe all safety regulations. Electrical wiring should be performed in accordance with all applicable national, state, and local codes to prevent damage to the meter and ensure personnel safety.

Connector Labeling

The connectors label, affixed to the meter, shows the location of all connectors available with requested configuration. It also identifies the location of the RTD/TC selector switch. The images below show all connector configurations for the PD765. Note that the connector in the upper left of the diagram has different configurations based on the model.

Note: # on the following figures refers to power options. (Example: PD765-6R0-00)

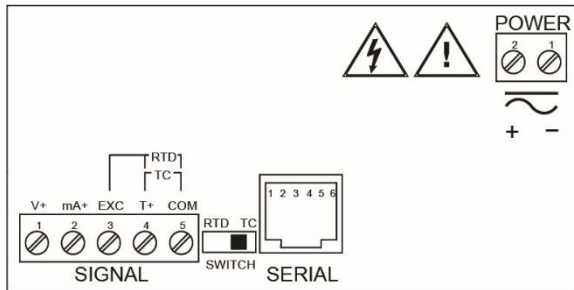

Figure 4. Connector Labeling for PD765-#R0-00

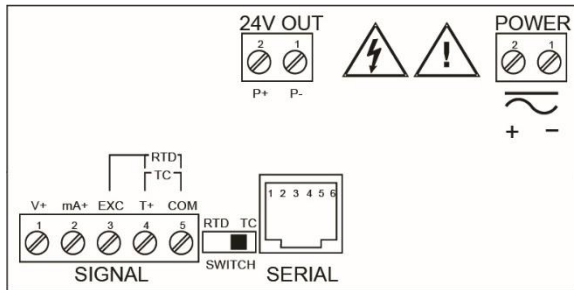

Figure 5. Connector Labeling for PD765-6R0-10

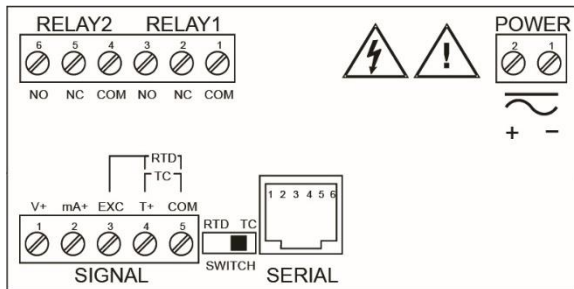

Figure 6. Connector Labeling for PD765-#R2-00

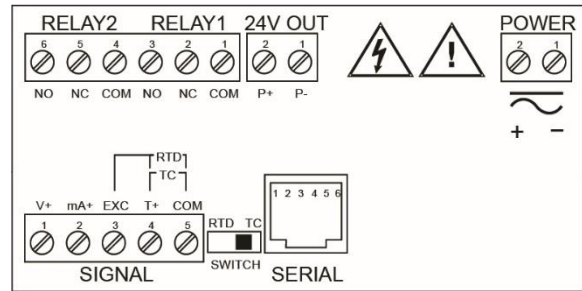

Figure 7. Connector Labeling for PD765-6R2-10

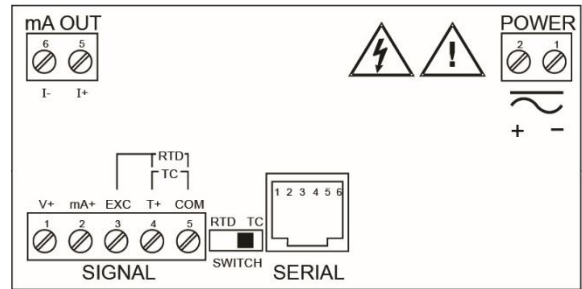

Figure 8. Connector Labeling for PD765-#R3-00

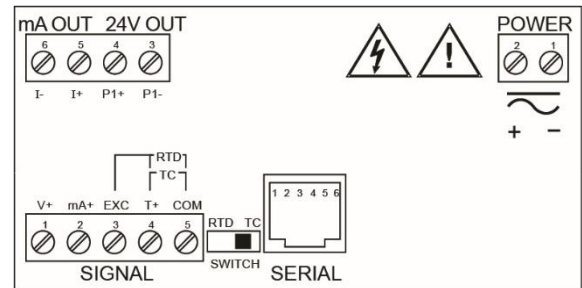

Figure 9. Connector Labeling for PD765-6R3-10

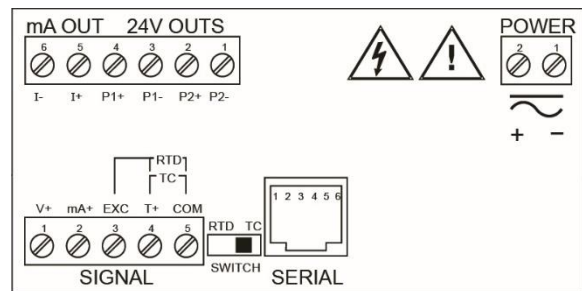

Figure 10. Connector Labeling for PD765-6R3-20

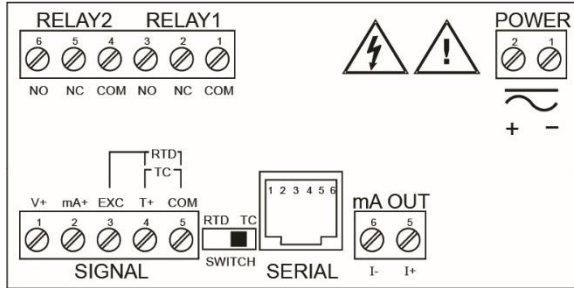

Figure 11. Connector Labeling for PD765-7R5-00

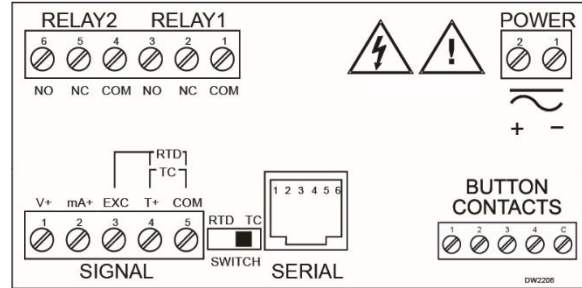

Figure 15. Connector Labeling for PD765-#X2-00

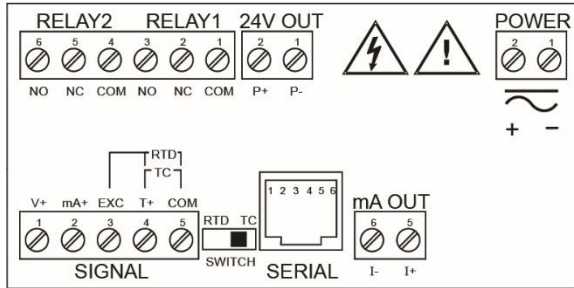

Figure 12. Connector Labeling for PD765-6R5-10

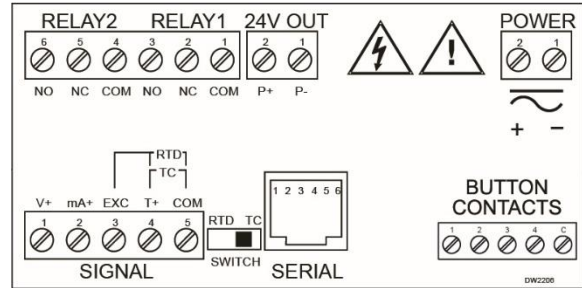

Figure 16. Connector Labeling for PD765-6X2-10

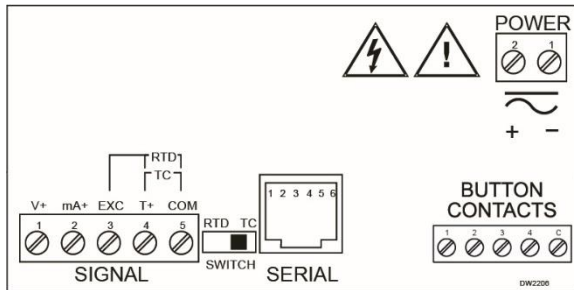

Figure 13. Connector Labeling for PD765-#X0-00

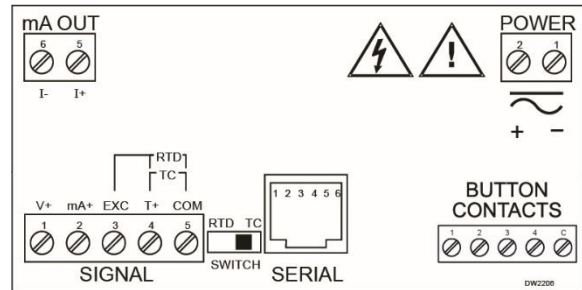

Figure 17. Connector Labeling for PD765-#X3-00

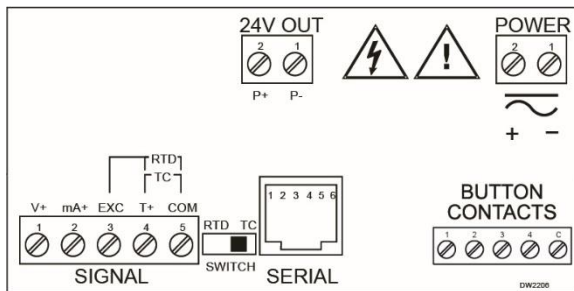

Figure 14. Connector Labeling for PD765-6X0-10

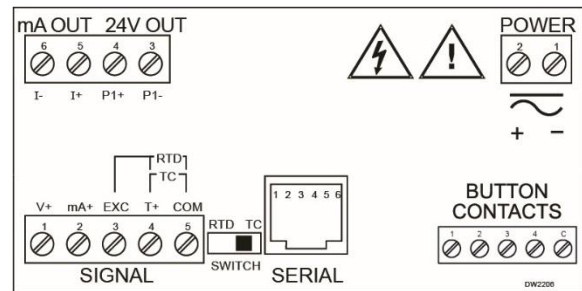

Figure 18. Connector Labeling for PD765-6X3-10

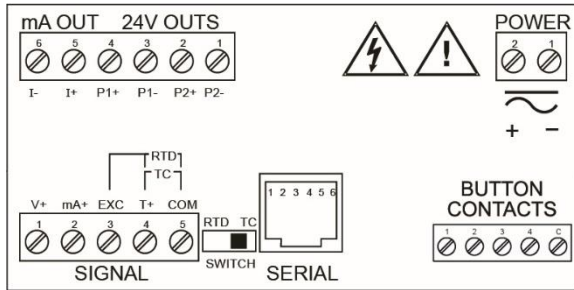

Figure 19. Connector Labeling for PD765-6X3-20

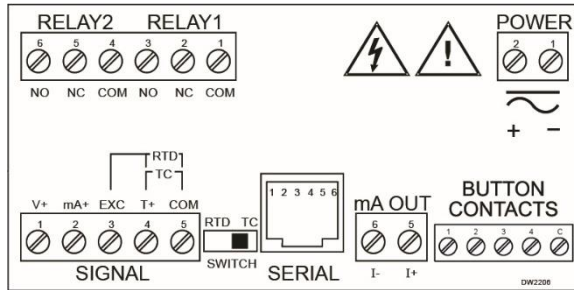

Figure 20. Connector Labeling for PD765-7X5-00

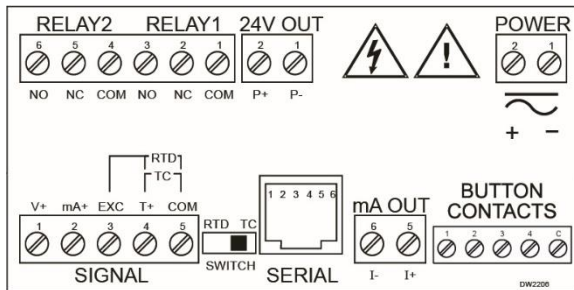

Figure 21. Connector Labeling for PD765-6X5-10

Power Connections

Power connections are made to a two-terminal connector labeled POWER on Figures 4-21. See *Connector Labeling* on page 14. The meter will operate regardless of DC polarity connection. The + and - symbols are only a suggested wiring convention.

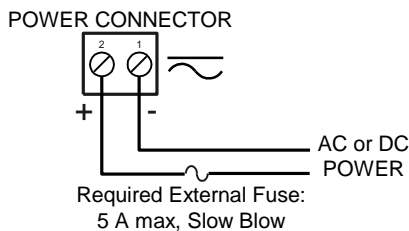

Figure 22. Power Connections

Signal Connections

Signal connections are made to a five-terminal connector labeled SIGNAL shown in Figures 4-21. See page 14. *Connector Labeling*. The COM (common) terminal is the return for all types of input signals.

Current and Voltage Connections

The following figures show examples for current and voltage connections.

There are no switches or jumpers to set up for current and voltage inputs. Setup and programming is performed through the front panel buttons.

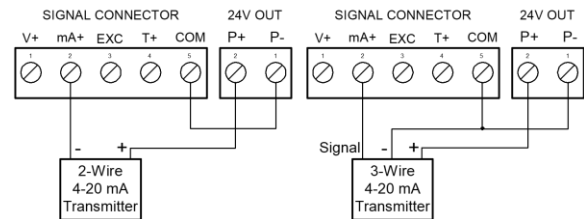

Figure 23. Transmitter Powered by Internal Supply (Optional - AC powered units only)

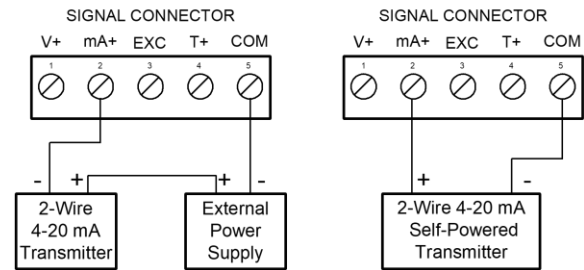

Figure 24. Transmitter Powered by External Supply or Self-Powered (Optional - AC powered units only)

The current input is protected against current overload by a resettable fuse. The display may or may not show a fault condition depending on the nature of the overload.

The fuse limits the current to a safe level when it detects a fault condition, and automatically resets itself when the fault condition is removed.

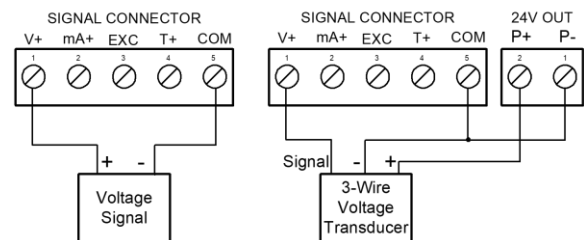

Figure 25. Voltage Input Connections

The meter is capable of accepting any voltage from -10 VDC to +10 VDC.

Thermocouple and RTD Connections

The following figures show examples for thermocouple and RTD connections. The RTD/TC selector switch must be set to the proper position for the meter to accept the selected temperature input. The input type is selected using the *Setup* menu. The selected thermocouple input must correspond to the thermocouple sensor and wire type used.

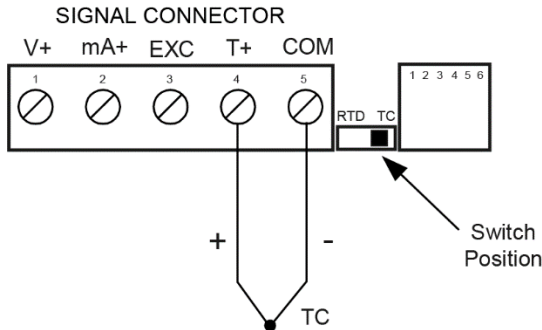

Figure 26. Thermocouple Input Connections

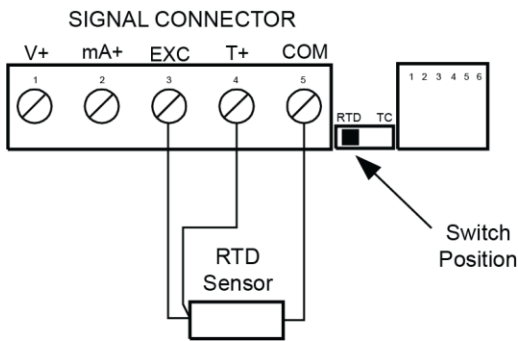

Figure 27. Three-Wire RTD Input Connections

The meter accepts two, three, or four-wire RTDs. The three-wire RTD connection has built-in lead wire compensation.

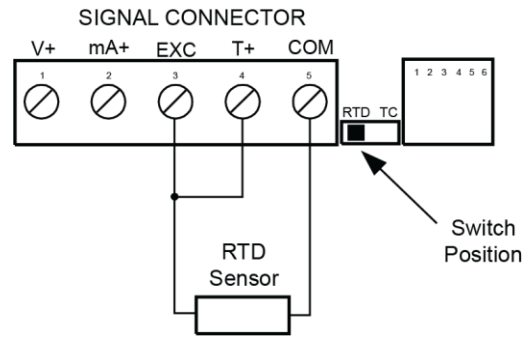

Figure 28. Two-Wire RTD Input Connections

Lead wire compensation for two-wire RTDs can be applied using the *Adjust* menu. See *Offset Adjustment (Adj)* on page 33.

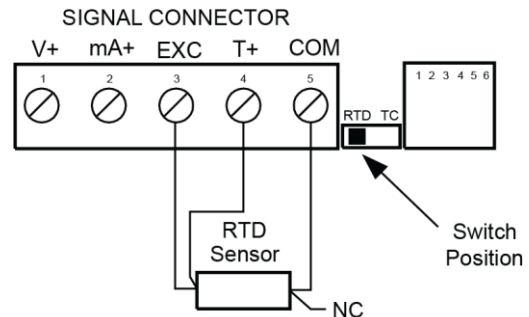

Figure 29. Four-Wire RTD Input Connections

The four-wire RTD connection is similar to the three-wire. One of the leads of a four-wire RTD is not connected and may be clipped off. The three-wire connection provides sufficient lead wire compensation to provide accurate readings even with long leads.

Serial Communication

Serial communication connection is made to an RJ11 connector labeled SERIAL. See Figures under *Connector Labeling* on page 14. Use [PDA7232](#) for RS-232 interfacing. Use [PDA7422](#) for RS-485 interfacing. Use [PDA7420](#) for meter-to-meter interfacing for cloning purposes (*i.e.* copying programmed settings from one meter to other meters).

Relays and 24 V Output Connections

Relay connections are made to a six-terminal connector labeled RELAY1, RELAY2. See Figures under *Connector Labeling* on page 14. The COM (common) terminals of the relays should not be confused with the COM (common) terminal of the SIGNAL connector. The 24 VDC output is available at the connector labeled 24V OUT, next to the relays connector.

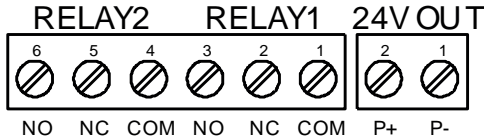

Figure 30. Relay & 24 V Output Connections

Switching Inductive Loads

The use of snubbers to suppress electrical noise is strongly recommended when switching inductive loads to prevent disrupting the microprocessor's operation. The snubbers also prolong the life of the relay contacts. Suppression can be obtained with resistor-capacitor (RC) networks assembled by the user or purchased as complete assemblies. Refer to the following circuits for RC network assembly and installation:

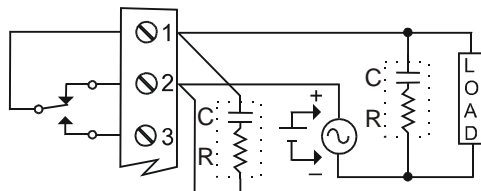

Figure 31. AC and DC Loads Protection

Choose R and C as follows:

R: 0.5 to 1 Ω for each volt across the contacts

C: 0.5 to 1 μF for each amp through closed contacts

Notes:

1. Inductive relay rating is 1/14 HP (50 W) at 115/230 VAC
2. Use capacitors rated for 250 VAC.
3. RC networks may affect load release time of solenoid loads. Check to confirm proper operation.
4. Install the RC network at the meter's relay screw terminals. An RC network may also be installed across the load. Experiment for best results.

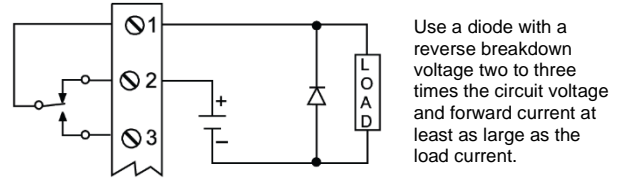

Use a diode with a reverse breakdown voltage two to three times the circuit voltage and forward current at least as large as the load current.

Figure 32. Low Voltage DC Loads Protection

RC Networks Available from Precision Digital

RC networks are available from Precision Digital and should be applied to each relay contact switching an inductive load. Part number: [PDX6901](#).

Note: Relays are de-rated to 1/14th HP (50 watts) with an inductive load.

4-20 mA Output & Input Signal Connections

The Trident X2, with an optional 4-20 mA output, can be used as an isolated temperature transmitter with a big display by converting the thermocouple or RTD input into an isolated 4-20 mA output.

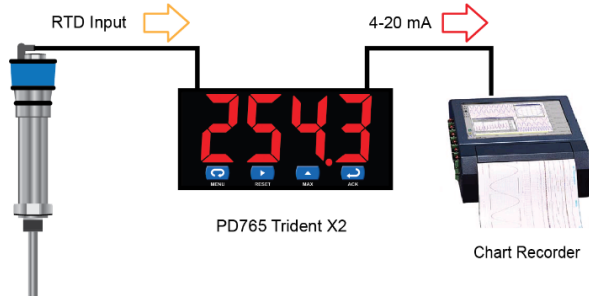

Connections for the 4-20 mA transmitter output are made to the connector terminals labeled "mA OUT: I-, I+". The 4-20 mA output may be powered from an internal power supply (optional) or from an external power supply.

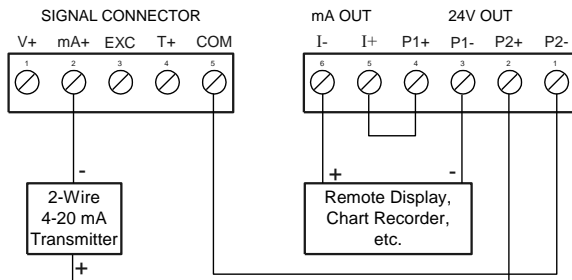

Figure 33. 4-20 mA Output & Input Signal Powered by Meter

Models include PD765-6R3-20 and PD765-6X3-20

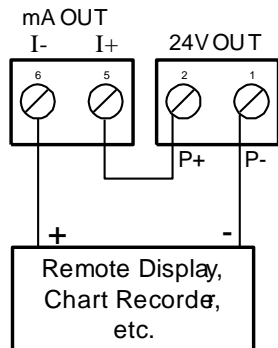

Figure 34. 4-20 mA Output Powered by Meter

Models include PD765-6R5-10, PD765-6X5-10

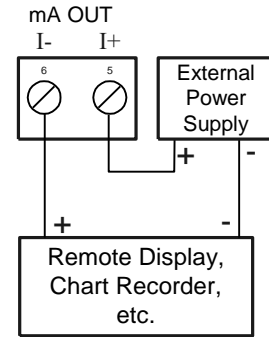

Figure 35. 4-20 mA Output Powered Externally

Models include PD765-6R3-00, PD765-6X3-00, PD765-7R3-00, PD765-7X3-00, PD765-7R5-00, PD765-7X5-00

Other Uses for Transmitter Power Supplies

The most common use for the Trident's two power supplies is for the 200 mA transmitter power supply to power the field transmitter and the other power supply to power the 4-20 mA output from the meter. However, the power supplies can be used in other ways. For instance, for level transmitters that require the use of a heated lens, the Trident's 200 mA power supply could be used to power both the heated lens and the 4-20 mA signal from the transmitter.

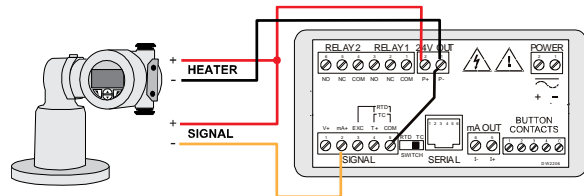

Figure 36. Trident X2 Powers Both the Heater and 4-20 mA Input Signal

Isolated 4-20 mA Signal Splitters & Converters

Precision Digital offers DIN rail mountable signal splitters and converters to split the optional 4-20 mA signal into two isolated 4-20 mA signals or into a 0-10 VDC signal.



Isolated 4-20 mA Signal Splitter

The Trident's optional 4-20 mA output can be split into two isolated 4-20 mA signals by using the model [PD659-1MA-2MA](#) 4-20 mA signal splitter.

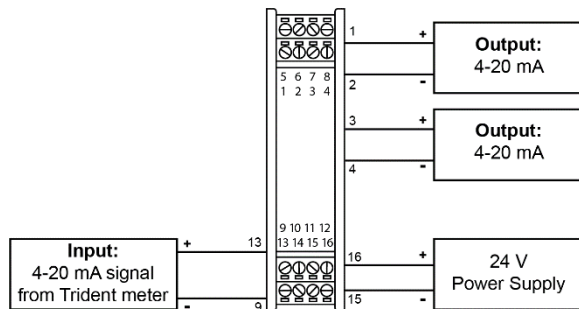

Figure 37. Passive 4-20 mA Output from Trident Meter Split into Two Isolated 4-20 mA Signals

4-20 mA to 0-10 VDC Signal Converter

The Trident's optional 4-20 mA output can be converted into a 0-10 VDC signal by using the model [PD659-1MA-1V](#) 4-20 mA to 0-10 VDC signal converter.

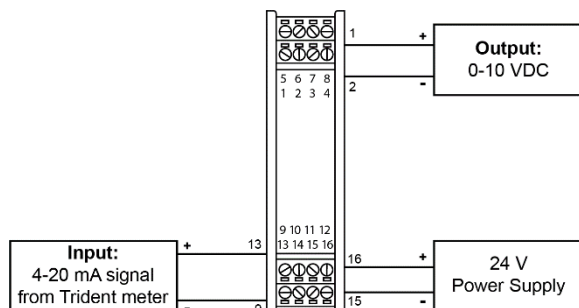

Figure 38. Passive 4-20 mA Output from Trident Meter Converted to 0-10 VDC Signal

External Button Contacts on Trident X2

The Trident X2 is equipped with four external button contacts that can be used to remotely operate the Trident X2's front panel buttons. For instance, these button contacts can be used to program the meter and to remotely acknowledge/reset the relays:



The external button contacts are particularly useful for wiring up a [remote button](#) to reset the relays as shown here:



Four-Position Control Station for Remote Operation of Trident PD765 X2 Buttons

The Trident PD765 X2's four programming and operations buttons can be remotely controlled by using the [PDA2364-MRUE](#) 4-button control station accessory as shown in the diagram below.

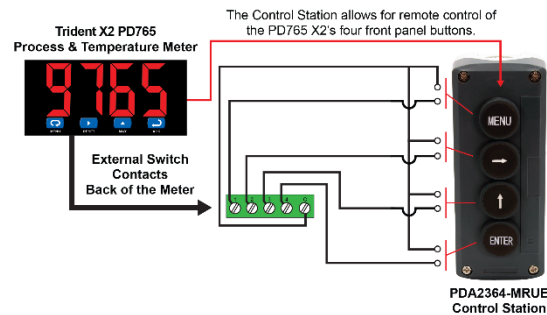

Setup and Programming

This section describes how to program the Trident meter using the front panel buttons. The Trident meter can also be programmed using *Meterview Software* as described on page 36, or by copying the programming from meter to the next as described on page 35.

- There is **no need to recalibrate** the meter when first received from the factory.
- The meter is **factory calibrated** prior to shipment, for all input types, in milliamps, volts, and degrees. The calibration equipment is certified to NIST standards.

Overview

There are no jumpers involved in the setup process of the meter. The RTD/TC selector switch, located between the SIGNAL and SERIAL connectors, must be set accordingly for the meter to accept RTD or thermocouple inputs. See Figures under *Connector Labeling* on page 14.

Setup and programming is done through the front panel buttons.

After power and signal connections have been completed and verified, apply power to the meter.

For Quick Interface Reference Guide go to page 47.

For Interactive Virtual Meter Demo visit predig.com/tvm

Trident Virtual Meter

Virtual Meter Instructions
Programming 4-20 mA input

These instructions will show you how to program the Trident Virtual Meter to accept a 4-20 mA input and display a value between 0 and 100.

- Click **[MENU]** to enter Programming Mode, then click **[1]** to access the **SEU** (Setup) menu and again to access the **mPS** (Input) menu.
- Select **Y-Ω** (4-20 mA) and click **[2]** to confirm input selection. This should be the default option, but if it is not, click **[2]** to scroll through the choices.
- Click **[.]** to access the **dSP** (Decimal Point) menu. Click **[.]** until the **0** (one decimal place) is displayed, then click **[2]** to confirm decimal point location.
- Click **[P]** to access the **PrOg** (Program) menu and again to access the **ScR** (Scale) menu.
- Click **[0]** to access **uP** (Input 1). This is the input which represents 0% of the process variable. The default value of **100** (4.00 mA) should be sufficient for most applications. Click **[0]** to accept this input value.
- Click **[5]** to access **d** (Display 1). This is the value that will be displayed on the meter when the current input is at 4 mA. Click **[4]** until the **1** digit is brighter than the others (meaning it is selected) and then click **[2]** to increment the digit until it displays **0**. Click **[2]** to accept the display value of **0000**.
- Repeat steps 5 and 6 for **mPS** (Input 2) and **d** (Display 2). Accept the default input value of **0000** for Input 2 and change the display 2 value to **0000** using the **[2]** and **[0]** buttons.
- Click **[2]** to exit Programming Mode and return to Run Mode. Slide the input slider to the right of the meter to the left and right. Notice that when the input slider is all the way to the left, the meter now displays **0000** and when the slider is all the way to the right, the meter displays **0000**.

Disclaimer: The Virtual Meter is not identical to its real counterpart. It cannot demonstrate all of the functionality, nor does it exactly resemble the physical meter.

Please note: The Virtual Meter closely approximates the functionality of the actual product. Both the real and virtual meters have additional functionality beyond that explained in the step-by-step instructions.

Front Panel Buttons and Status LED Indicators

Trident Standard Display



Trident X2 Display



Button Symbol	Description	LED	Status
	Menu	1	Alarm 1
	Right arrow / Reset	2	Alarm 2
	Up arrow / Max	S*	Set point indicator
	Enter / Ack	R*	Reset point indicator

*S and R indicators do not appear on X2 versions.

- Press the **Menu** button to enter or exit the Programming Mode at any time.
- Press the **Right** arrow button to move to the next digit during digit programming.
- Press the **Up** arrow button to scroll through the menus, decimal point, or to increment the value of a digit.
- Press the **Enter/Ack** button to access a menu or to accept a setting.
- Press the **Right** arrow and **Menu** button simultaneously or hold the **Menu** button for approximately 3 seconds to access the *Advanced Features Menu* of the meter.

Display Functions and Messages

The meter displays various functions and messages during setup/programming and operation. The following table shows the displayed functions and messages with their action/setting description.

Display	Parameter	Action/Setting
SEtU	Setup	Enter Setup menu
INPt	Input	Enter Input menu
4-20	4-20 mA	Set meter for 4-20 mA input
0-10	0-10 VDC	Set meter for ±10 VDC input
RTD	RTD	Set meter for RTD input
R385	Alpha 385	Set $\alpha = 0.00385$ European curve 100 Ω RTD
R392	Alpha 392	Set $\alpha = 0.00392$ American curve 100 Ω RTD
TC	TC	Set meter for TC input
0 J	0 J	Type J
1 K	1 K	Type K
2 T	2 T	Type T
3 T.0	3 T.0	Type T, 0.1° resolution
4 E	4 E	Type E
F C	°F or °C	Set temperature scale
°F	°F	Set meter to Fahrenheit
°C	°C	Set meter to Celsius
dEcP	Decimal point	Set decimal point
PrOG	Program	Enter the Program menu
ScAL	Scale	Enter the Scale menu
CL	Calibrate	Enter the Calibrate menu
INP 1	Input 1	Calibrate input 1 signal or program input 1 value
d IS 1	Display 1	Program display 1 value
INP 2	Input 2	Calibrate input 2 signal or program input 2 value
d IS 2	Display 2	Program display 2 value
Err	Error	Error, calibration not successful, check signal
RELY	Relay	Enter the Relay menu
RLY 1	Relay 1	Relay 1 setup
Act 1	Action 1	Set relay 1 action (automatic, latching, etc.)
Auto	Automatic	Set relay for automatic reset
Auto-manual	Auto-manual	Set relay for automatic + manual reset any time
Latching	Latching	Set relay for latching operation
Latching-cleared	Latching-cleared	Set relay for latching operation with manual reset only after alarm condition has cleared
ALter	Alternate	Set relays for pump alternation control
OFF	Off	Disable relay and front panel status LEDs Disable relay's fail-safe operation

Display	Parameter	Action/Setting
SEt 1	Set 1	Program set point 1
rSE 1	Reset 1	Program reset point 1
RLY 2	Relay 2	Setup relay 2
Act 2	Action 2	Set relay 2 action (automatic, latching, etc.)
SEt 2	Set 2	Program set point 2
rSE 2	Reset 2	Program reset point 2
FLSF	Fail-safe	Enter Fail-safe menu
FLS 1	Fail-safe1	Set relay 1 fail-safe operation
On	On	Enable fail-safe operation
OFF	Off	Disable fail-safe operation
FLS 2	Fail-safe2	Set relay 2 fail-safe operation
dLRY	Delay	Enter Time Delay menu
dLY 1	Delay 1	Enter relay 1 time delay setup
On 1	On 1	Set relay 1 On time delay
OFF 1	Off 1	Set relay 1 Off time delay
dLY 2	Delay 2	Enter relay 2 time delay setup
On 2	On 2	Set relay 2 On time delay
OFF 2	Off 2	Set relay 2 Off time delay
brEH	Break	Set RTD/TC input break relay behavior
brH 1	Relay 1 Break	Set relay 1 input break relay behavior
OFF	Off	Set relay to non-alarm condition at break
On	On	Set relay to alarm condition at break
brH 2	Relay 2 Break	Set relay 2 input break relay behavior
Rowt	Analog output	Enter the Analog output menu
ScAL	Scale	Enter the Scale menu
d IS 1	Display 1	Program display 1 value
out 1	Output 1	Program output 1 value (e.g. 4 mA)
d IS 2	Display 2	Program display 2 value
out 2	Output 2	Program output 2 value (e.g. 20 mA)
SEbr	Sensor break	Program TC or RTD sensor break value for analog out
PASS	Password	Enter the Password menu
unLC	Unlocked	Program password to lock meter
LoCd	Locked	Enter password to unlock meter
9999 - 1999	Flashing display	Overrange condition
oPEN	Open TC or RTD sensor	Underrange condition

Main Menu

The main menu consists of the most commonly used functions: *Setup* and *Password*.

- Press **Menu** button to enter Programming Mode then press **Up** arrow button to scroll main menu.

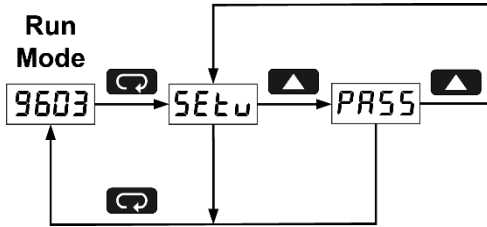

- Press **Menu**, at any time, to exit and return to Run Mode. Changes made to settings prior to pressing **Enter/Ack** are not saved.
- Changes to the settings are saved to memory only after pressing **Enter/Ack**.
- The display moves to the next menu every time a setting is accepted by pressing **Enter/Ack**.

Setting Numeric Values

The numeric values are set using the **Right** and **Up** arrow buttons. Press **Right** arrow to select next digit and **Up** arrow to increment digit value.

The digit being changed is displayed brighter than the rest.

Press the **Enter/Ack** button, at any time, to accept a setting or **Menu** button to exit without saving changes.

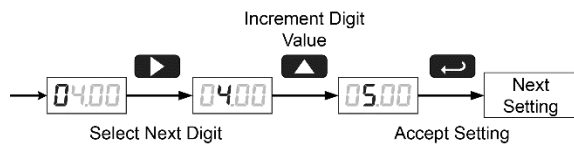

The decimal point is set using the **Up** arrow button in the *Setup-decimal point* menu.

Setting Up the Meter (SETUP)

The *Setup* menu is used to select:

- Input signal the meter will accept
- Decimal point position for process inputs
- Units (°F or °C) for temperature inputs
- Relay operation
- 4-20 mA analog output setup

Press the **Enter/Ack** button to access any menu or press **Up** arrow button to scroll through choices. Press the **Menu** button to exit at any time.

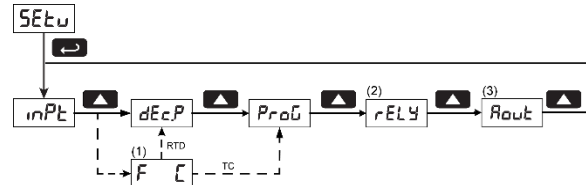

Notes:

- Selecting RTD or TC mode from the Input menu will include the Fahrenheit/Celsius menu in the setup menu structure. RTD will allow the selection of a decimal point location after this menu and TC has a fixed decimal point location and will not allow the selection of a decimal point location.
- Relay menu is always available even if relays option is not installed. Visual alarm indication is available through front panel LEDs and MeterView software.
- Analog Output menu is available if selected in the Advanced Features menu. 4-20 mA output option board is installed and set up at the factory.

Setting the Input Signal (inPt)

Enter the *Input* menu to set up the meter to display current (4-20), voltage (0-10), thermocouple (tC), or RTD (rtd) inputs.

The voltage input is capable of accepting any signal from -10 to +10 VDC. Select voltage input to accept 0-5, 1-5, 0-10, or ±10 VDC signals.

The current input is capable of accepting any signal from -20 to 20 mA. Select current input to accept 0-20 or 4-20 mA signals.

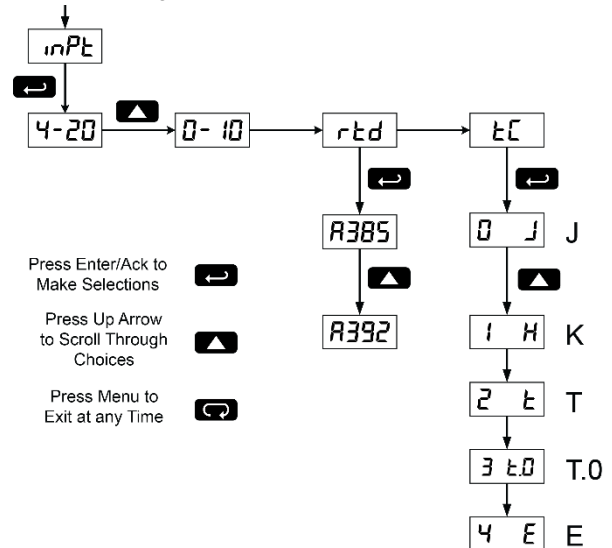

If RTD is selected, the display shows **R385** or **R392**. Select the coefficient to match the RTD sensor, either 0.00385 (**R385**, European curve) or 0.00392 (**R392**, American curve). The display then shows the decimal point menu, **dEcP**. Select the decimal point resolution as shown on page 24.

If TC is selected, scroll through the thermocouple types and select the type matching the TC sensor. The input signal must be connected to the appropriate input terminals and the RTD/TC selector switch must be set, see *Figure 26. Thermocouple Input Connections* on page 17.

For thermocouple inputs, allow at least 30 minutes warm-up time for meter to reach specified accuracy.

Setting the Decimal Point (d.c.Pt)

The decimal point for process inputs may be set with up to three decimal places or with no decimal point at all.

The decimal point for RTD inputs may be set with 1 decimal place or none.

The decimal point for thermocouple inputs is fixed per input selection.

Pressing the **Up** arrow moves the decimal point one place to the right until no decimal point is displayed, it then moves to the leftmost position.

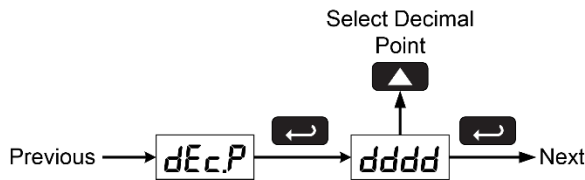

Setting the Temperature Scale (F C)

Meters with a thermocouple or RTD input can be set to display temperature in degrees Fahrenheit or Celsius.

Press **Up** arrow to change selection.

Press **Enter/Ack** to accept.

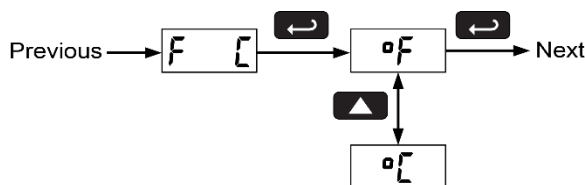

Programming the Meter (Prog)

The meter may either be scaled (**ScAL**) without applying an input or calibrated (**Cal**) by applying an input. The meter comes factory calibrated to NIST standards, so for initial setup, it is recommended to use the (**ScAL**) function.

The Program menu contains the Scale (**ScAL**) and the Calibrate (**Cal**) menus.

Process inputs may be scaled or calibrated to any display within the range of the meter.

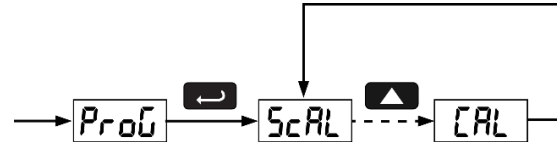

Scaling the Meter (ScAL)

The process inputs (4-20 mA and ±10 VDC) can be scaled to display the process in engineering units.

A signal source is not needed to scale the meter; simply program the inputs and corresponding display values.

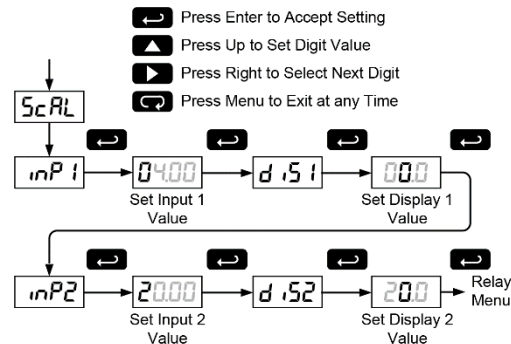

For instructions on how to program numeric values see *Setting Numeric Values*, page 23.

Note: The *Scale* menu is not available for temperature inputs.

Error Message (Err)

An error message indicates that the calibration or scaling process was not successful.

After the error message is displayed, the meter reverts to input 1, allowing the appropriate input signals to be applied.

The error message might be caused by any of the following conditions:

1. Input signal is not connected to the proper terminals or it is connected backwards.
2. Wrong signal selection in *Setup* menu.
3. Minimum input span requirements not maintained.
4. Input 1 signal inadvertently applied to calibrate input 2.

Minimum Input Span

The minimum input span is the minimum difference between input 1 and input 2 signals required to complete the calibration or scaling of the meter.

Input range	Input 1 & input 2 span
4-20 mA	0.40 mA
±10 VDC	0.20 VDC
TC	100°F (56°C)
RTD	50°F (28°C)

Calibrating the Meter (CAL)

The meter can be calibrated to display the process in engineering units by applying the appropriate input signals and following the calibration procedure.

The use of a calibrated signal source is required to calibrate the meter.

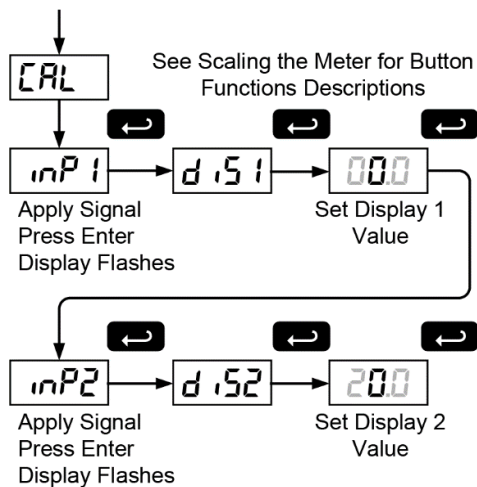

Recalibrating Temperature Inputs (CAL)

Remember, the meter is **calibrated** at the factory prior to shipment. Recalibration is recommended at least every twelve months.

The *Calibration (CAL)* menu is used to **recalibrate** the thermocouple and RTD inputs.

Allow at least 30 minutes warm-up time before performing recalibration procedure to ensure specified accuracy.

Recommended Calibration Points

To recalibrate the meter, it is recommended to use the Fahrenheit scale; this will give a greater degree of accuracy to the calibration. The scale can be changed to the Celsius scale after calibration is completed. The meter will display temperature accurately in any scale. The following table shows the recommended low and high calibration points for all types.

Type of input	Input 1 (Low)	Input 2 (High)	Check (Middle)
Type J T/C	32°F	1182°F	600°F
Type K T/C	32°F	1893°F	960°F
Type T T/C	32°F	693°F	360°F
Type T T/C	32.0°F	693.0°F	360.0°F
Type E T/C	32°F	1652°F	840°F
100 Ω RTD (0.00385)	32°F 100Ω	1148°F 320.12Ω	590°F 215.61Ω
100 Ω RTD (0.00392)	32°F 100Ω	1127°F 320.89Ω	580°F 215.87Ω

Recalibration Procedure for Temperature Inputs

1. Connect signal to the meter using the appropriate wire (e.g. type J thermocouple wire to recalibrate type J input), see page 17.
2. Set up the meter to accept the selected input (e.g. type J T/C), see page 23.
3. Set up the meter to display temperature in degrees Fahrenheit, see page 24.
4. Apply signal corresponding to input 1 (32°F) and program display 1 to 32, see page 25.
5. Apply signal corresponding to input 2 (1182°F for type J) and program display 2 accordingly, see page 25.
6. After the meter accepts input 2, the display flashes the message [J- that indicates the meter is sensing the cold junction reference. This completes the recalibration procedure for the selected input.

Recalibrating Process Inputs (iCAL)

The *Internal Calibration (iCAL)* menu, located in the Advanced features menu, is used to recalibrate the current and voltage inputs. Recalibration is recommended at least every twelve months.

Refer to *Internal Calibration (iCAL)*, page 42 for instructions.

Setting the Relay Operation (rELY)

This menu allows you to set up the operation of the relays:

1. Relay action (REL)
 - a. Automatic reset only (non-latching)
 - b. Automatic + manual reset at any time (non-latching)
 - c. Latching (manual reset only)
 - d. Latching with Clear (manual reset only after alarm condition has cleared)
 - e. Pump alternation control (automatic reset only)
 - f. Off (relay and status LED disabled)
2. Set point
3. Reset point
4. Fail-safe operation
 - a. On (enabled)
 - b. Off (disabled)
5. Time delay
 - a. On delay (0-199 seconds)
 - b. Off delay (0-199 seconds)
6. Break Condition Behavior
 - a. Off (non-alarm condition)
 - b. On (alarm condition)

Refer to page 22 for a description of *Display Functions and Messages*

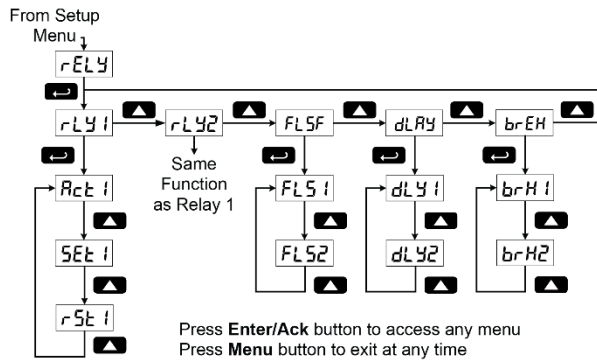

Setting the Relay Action

The relays' Action menu allows the user to set up the operation of the relays. The relays may be set up for any of the following modes of operation:

1. Automatic reset (non-latching)
2. Automatic + manual reset at any time (non-latching)
3. Latching (manual reset only, at any time)
4. Latching with Clear (manual reset only after alarm condition has cleared)
5. Pump alternation control (automatic reset only)
6. Off (relay and status LED disabled)

The following graphic shows relay 1 action setup; relay 2 is set up in a similar fashion.

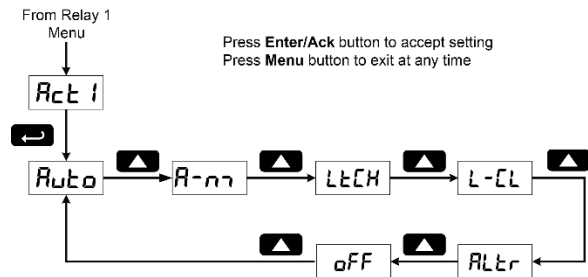

Programming Set and Reset Points

High alarm indication: program set point above reset point.

Low alarm indication: program set point below reset point.

The deadband is determined by the difference between set and reset points. Minimum deadband is one display count. If set and reset points are programmed the same, relay will reset one count below set point.

Quick Set Points

Press **Up** arrow and **Menu** at the same time to access set/reset points quickly.

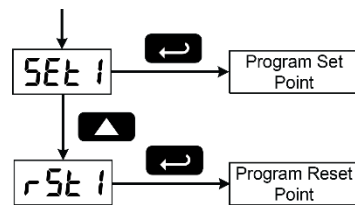

Setting Fail-Safe Operation

The fail-safe operation is set independently for each relay. Select **on** to enable or select **off** to disable fail-safe operation.

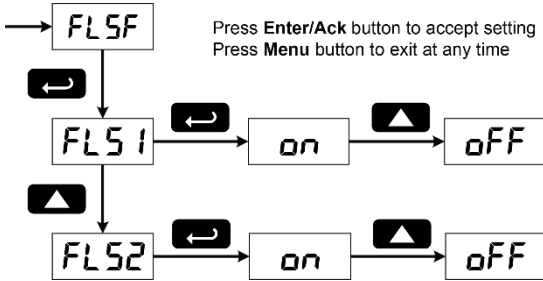

Programming Time Delay

The On and Off time delays may be programmed for each relay between 0 and 199 seconds. The relays will transfer only after the condition has been maintained for the corresponding time delay.

The On time delay is associated with the set point.
The Off time delay is associated with the reset point.

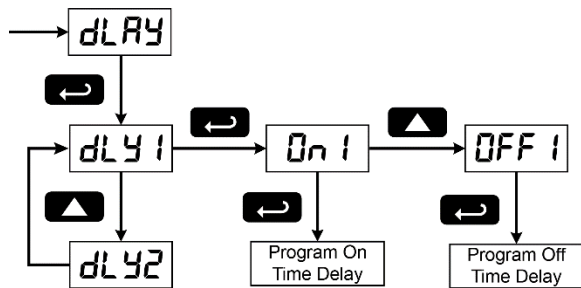

Setting Sensor Break Condition

The sensor break relay condition may be programmed for each relay as On (alarm) or Off (non-alarm). The relays will enter these states when a sensor break is detected for RTD or thermocouple inputs. These settings have no effect when current or voltage inputs are selected.

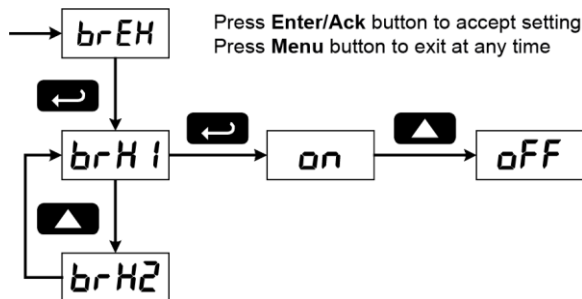

Sensor Break Operation

The following graphs illustrate the operation of how the meter reacts when a sensor break is detected.

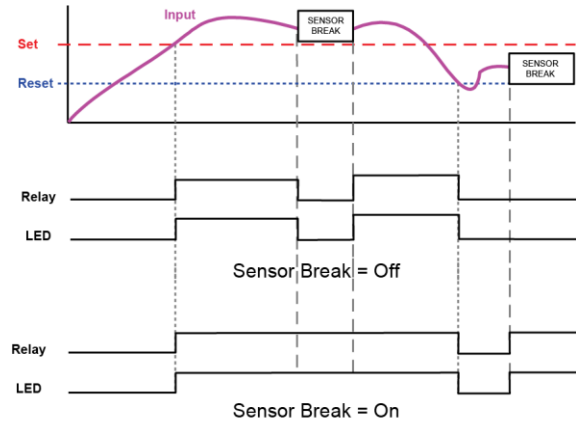

Relay and Alarm Operation

The following graphs illustrate the operation of the relays, status LEDs, and ACK button.

High Alarm Operation (Set > Reset)

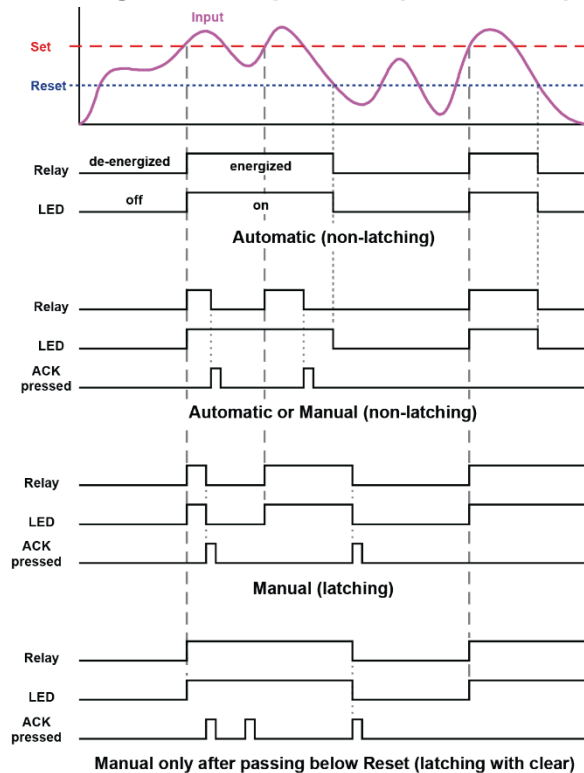

For Manual reset mode, ACK can be pressed anytime to turn "off" relay. For relay to turn back "on", signal must go below set point, and then go above it.

Low Alarm Operation (Set < Reset)

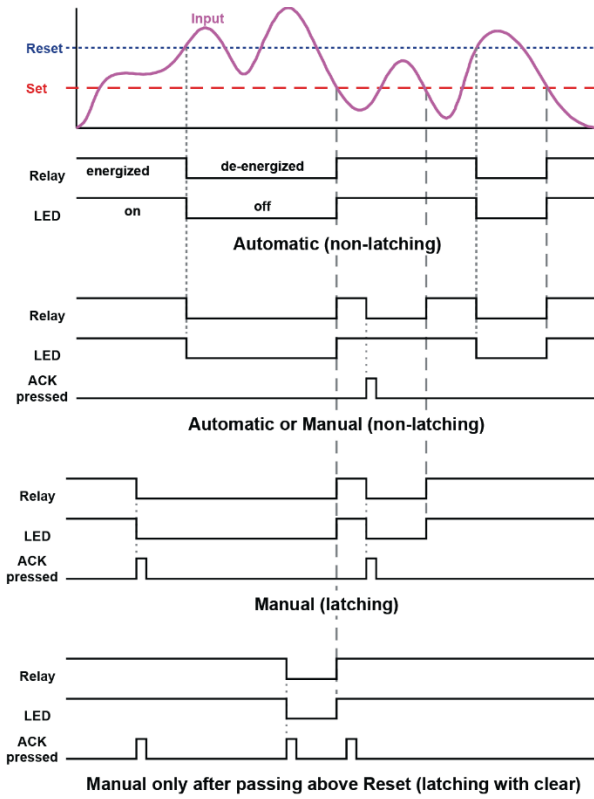

For Manual reset mode, ACK can be pressed anytime to turn "off" relay. For relay to turn back "on", signal must go above set point, and then go below it.

Time Delay Operation

The following graphs show the operation of the time delay function.

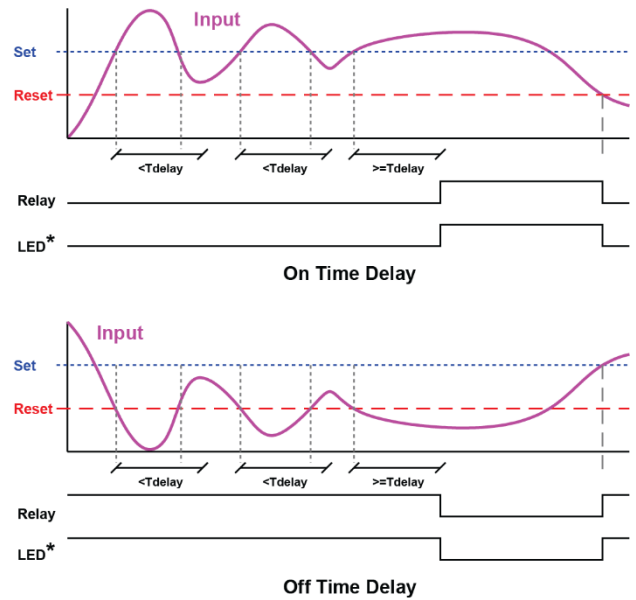

If the signal crosses the set point, the *On* time delay timer starts and the relay trips when the time delay has elapsed. If the signal drops below the set point (high alarm) before the time delay has elapsed, the *On* time delay timer resets and the relay does not change state. The same principle applies to the *Off* time delay.

* **Note:** The LED is not affected by Time Delay when "Automatic or Manual" reset mode is selected. Rather the LED follows the set and reset points.

High Alarm with Fail-Safe Operation (Set > Reset)

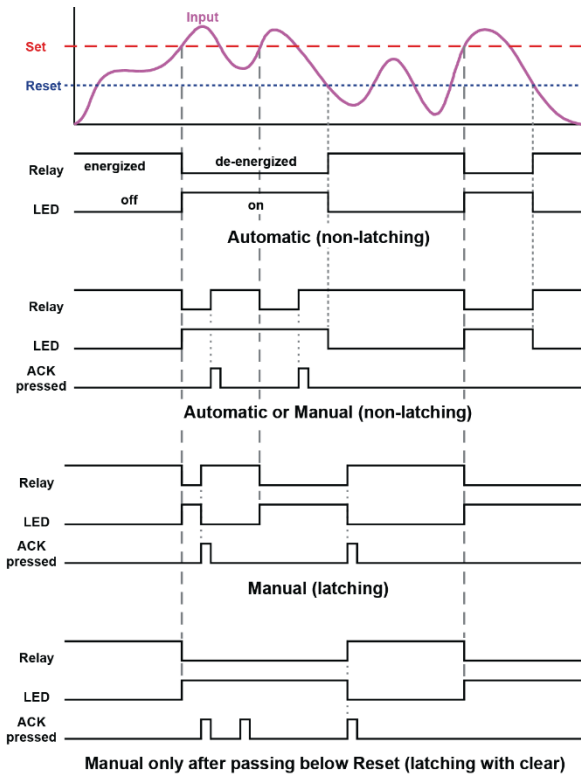

Fail-safe operation: relay coil is energized in non-alarm condition. In case of power failure, relay will go to alarm state.

Low Alarm with Fail-Safe Operation (Set < Reset)

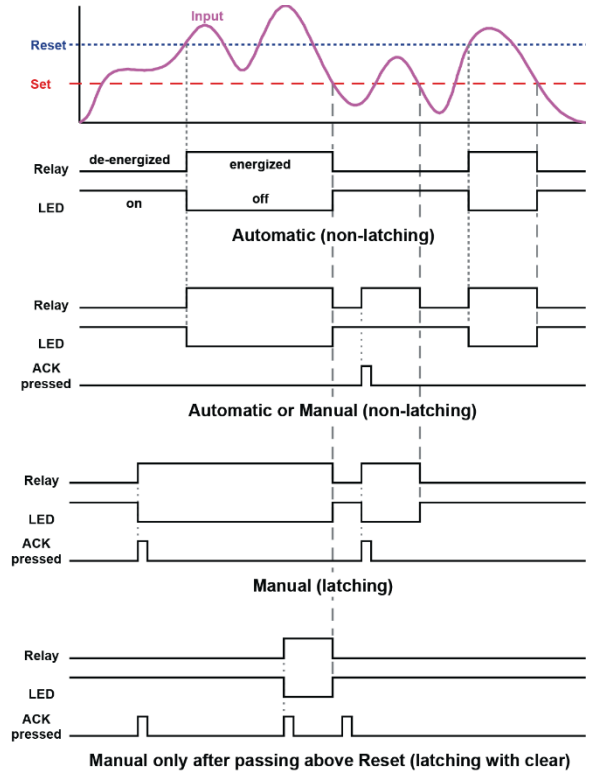

Fail-safe operation: relay coil is energized in non-alarm condition. In case of power failure, relay will go to alarm state.

Pump Controller with Dual-Pump Alternation

The PD765 can be used as a low-cost pump controller when combined with a continuous level transmitter. One of the most common pump control application is shown below: controlling and alternating two pumps. The goal is to control the level between 1000 and 6000 gallons. The main pump turns on when the level reaches 6000 gallons and pumps down to 1000 gallons and then shuts the pump off. The next cycle, the backup pump turns on at 6000 gallons and shuts off at 1000 gallons. If at any time the active pump can't keep the level below 7000 gallons, the other pump would come on also.

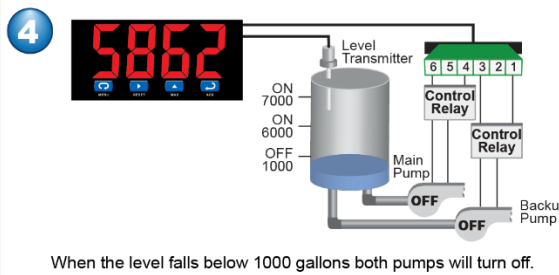
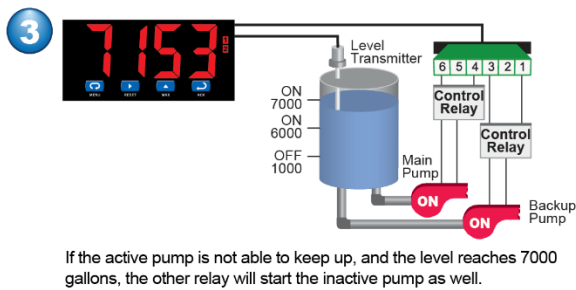
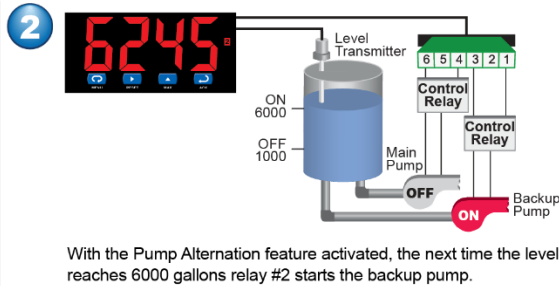
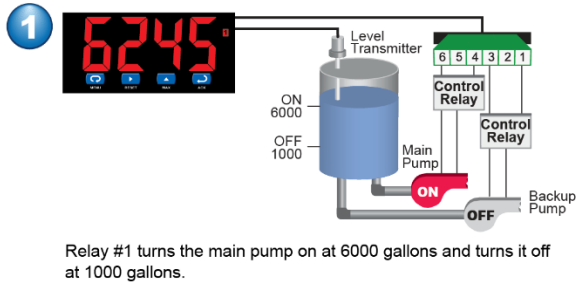

Pump Alternation Control Operation

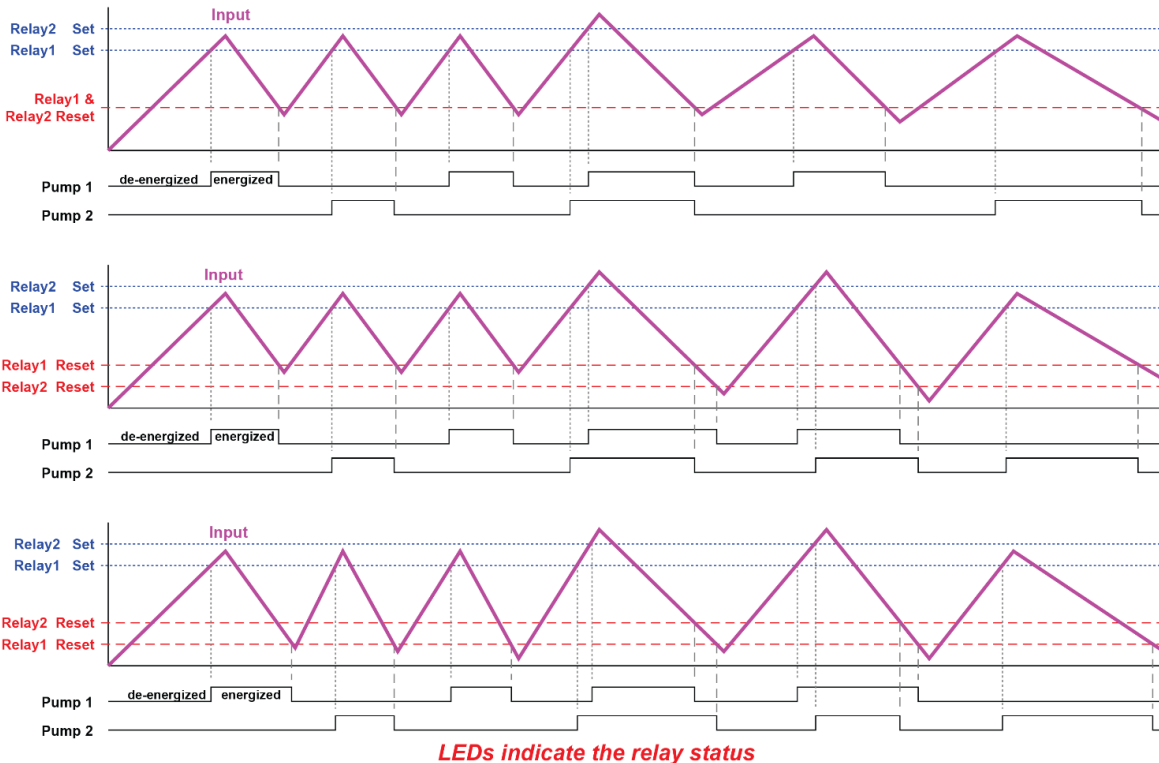

Scaling the 4-20 mA Analog Output (Rout)

The 4-20 mA analog output can be scaled to provide a 4-20 mA signal for any display range selected.

No equipment is needed to scale the analog output; simply program the display values to the corresponding mA output signal.

The *Analog Output* menu appears in the *Setup* menu only on meters that are equipped with a 4-20 mA output. This menu is enabled or disabled at the factory via the *Advanced Features* menu. For more information on the *Advanced Features Menu* see page 32.

The *Analog Output* menu is used to program:

1. 4-20 mA output based on display values
2. Sensor break value in mA

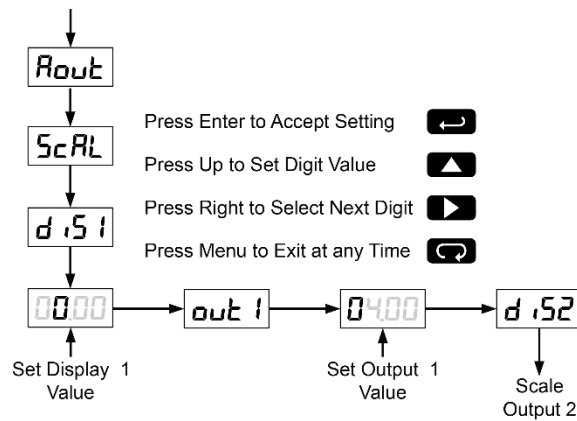

For instructions on how to program numeric values see *Setting Numeric Values*, page 23.

Isolated 4-20 mA Signal Splitters & Converters

Precision Digital offers DIN rail mountable signal splitters and converters to split the optional 4-20 mA signal into two isolated 4-20 mA signals or into a 0-10 VDC signal.



For more information see page 20.

Program the Sensor Break Output Value (SEbr)

The sensor break value corresponds to the output signal generated when the meter detects a sensor break for thermocouple and RTD inputs.

For example if there is an open thermocouple, the meter displays the message "oPEr" and the analog output goes to the programmed sensor break value (e.g. 3.00 mA).

The sensor break value can be programmed from 0.00 to 23.99.

The typical output signal range is 1.00 to 23.00 mA (e.g. If sensor break value is programmed to 0.00, the actual output will not be greater than 1.00 mA).

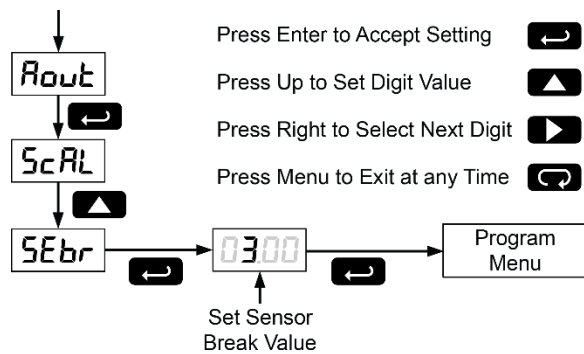

Analog Output when Display is Out of Range

The analog output reflects the display out of range conditions as follows:

Input Condition	Display	Analog Output
Underrange	Flashing -1999	3.00 mA
Overrange	Flashing 9999	21.00 mA
Open TC or RTD	Flashing oPEr	Sensor break value

Setting Up the Password (PASS)

The *Password* menu is used to program a four-digit password to prevent unauthorized changes to the programmed parameter settings.

Locking the Meter

Enter the *Password* menu and program a four-digit password.

For instructions on how to program numeric values see *Setting Numeric Values*, page 23.

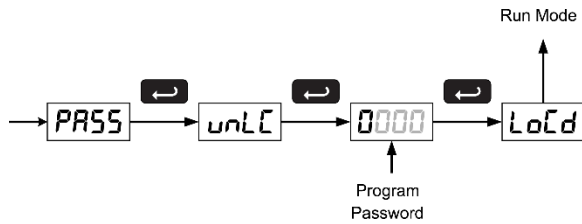

Record the password for future reference. If appropriate, it may be recorded in the space provided.

Model:	
Serial Number:	
Password:	__ __ __ __

Unlocking the Meter

If the meter is password protected, the correct password must be entered in order to make changes to the parameter settings.

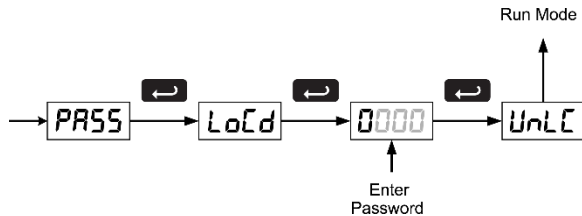

Entering the correct four-digit number sets the password to 0000, disabling the protection.

Changes to the programmed parameter settings are allowed only with the password set to 0000.

If the password entered is incorrect, the meter displays *LoCd* (Locked) for about two seconds, then it returns to Run Mode. To try again, press **Enter/Ack** while the *Locked* message is displayed.

Forgot the Password?

The password may be disabled by the following procedure:

1. Note display reading prior to pressing the Menu button. Ignore decimal point and sign.
2. Access the *Password* menu, add 2 to the noted reading and enter that number as the password (e.g. display reading = -1.23, password = 0125)

Advanced Features Menu

To simplify the setup process, functions not needed for most applications are located in the *Advanced Features* menu.

Press the **Right** arrow and **Menu** button simultaneously or hold the Menu button for approximately 3 seconds to access the *Advanced Features Menu* of the meter.

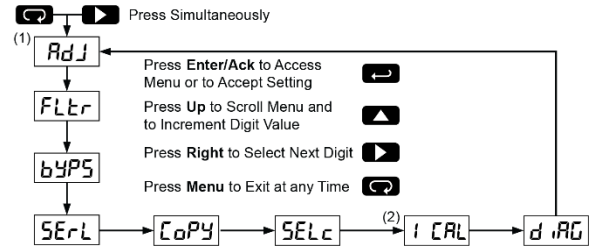

1. Available for temperature inputs only
2. Available for process inputs only

Advanced Features Menu & Display Messages

Display Functions and Messages		
Display	Parameter	Action/Setting
RdJ	Adjust	Set offset adjustment for temperature, not available for process inputs
FLtr	Filter	Set noise filter value
bYP5	Bypass	Set filter bypass value
SErL	Serial	Set serial communication parameters
PrOt	Protocol	Enter the Protocol menu
PdC	PDC	Select PDC protocol
m b5	Modbus	Select Modbus protocol
Rddr	Address	Set meter address
bRud	Baud rate	Select baud rate
t r dE	Transmit delay	Set transmit delay for serial communication
Pr tY	Parity	Select none, even, or odd (Modbus only)
t bYt	Byte-to-byte	Program byte-to-byte timeout (silent time – Modbus only)
CoPY	Copy	Enter copy function
SEnd	Send	Send meter settings to

Display Functions and Messages		
Display	Parameter	Action/Setting
		another meter
<i>donE</i>	<i>Done</i>	Copy function completed
<i>SElc</i>	<i>Select</i>	Enter the Select menu (function, cutoff, out)
<i>Func</i>	<i>Function</i>	Select linear or square root function
<i>Linr</i>	<i>Linear</i>	Set meter for linear function
<i>SqrE</i>	<i>Square root</i>	Set meter for square root extraction
<i>cUtF</i>	<i>Cutoff</i>	Set low-flow cutoff
<i>out</i>	<i>Output</i>	Set meter for either relay or analog output (factory set only; only included in certain models)
<i>Rout</i>	<i>Analog output</i>	Set meter for analog output option
<i>rELY</i>	<i>Relay</i>	Set meter for relay option
<i>Rout</i>	<i>Analog output</i>	Enable or disable analog output (factory set only; only included in certain models)
<i>YES</i>	<i>Yes</i>	Enable analog output
<i>no</i>	<i>No</i>	Disable analog output
<i>intY</i>	<i>Intensity</i>	Select display intensity
<i>ICAL</i>	<i>Initial calibration</i>	Enter initial calibration for process inputs
<i>Cur</i>	<i>Current</i>	Calibrating current input
<i>lLo</i>	<i>l low</i>	Calibrate low current input
<i>lHi</i>	<i>l high</i>	Calibrate high current input
<i>volt</i>	<i>Volt</i>	Calibrating voltage input
<i>vLo</i>	<i>V low</i>	Calibrate low voltage input
<i>vHi</i>	<i>V high</i>	Calibrate high voltage input
<i>d iRG</i>	<i>Diagnostics</i>	Display parameter settings
<i>LEd</i>	<i>LED</i>	Test display
<i>CJC</i>	<i>CJC</i>	Display cold junction compensation voltage
<i>CFG</i>	<i>CFG</i>	Display meter configuration
<i>PtS</i>	<i>Points</i>	Display calibration points for process inputs
<i>rELY</i>	<i>Relays</i>	Display relay settings
<i>Rout</i>	<i>Analog output</i>	Display analog output settings
<i>GOFF</i>	<i>Gain/offset</i>	Display gain and offset for process inputs
<i>SErL</i>	<i>Serial</i>	Display serial communication settings
<i>inFo</i>	<i>Information</i>	Display software version and S/N information

Offset Adjustment (*Adj*)

This parameter allows the user to select an offset adjustment to the temperature being displayed. Offset adjustment values can be either positive or negative and can be any number within $\pm 19.9^\circ$. The offset adjustment value is programmed through the *Adjust* menu.

The offset adjustment feature can be useful to compensate for errors due to thermocouple junctions or excessive lead wire resistance in RTDs.

The offset adjustment value is automatically reset to zero whenever the type of temperature sensor is changed (*i.e.* Thermocouple type or RTD curve).

Celsius/Fahrenheit conversion of the offset adjustment value is automatic, see note 2 below for important limitations.

Notes:

1. Offset adjustment is available only when TC or RTD input is selected.
2. If adjustment value is greater than 11°C and the temperature scale is changed to Fahrenheit, the maximum applied adjustment will be 19.9°F .

Noise Filter (*FLtr*)

Most applications do not require changing this parameter. It is intended to help attain a steady display with an unsteady (noisy) input signal.

The field selectable noise filter averages any minor or quick changes in the input signal and displays the reading with greater stability.

Increasing the filter value will help stabilize the display, however this will reduce the display response to changes on the input signal.

The filter level may be set anywhere from 2 to 199.

Setting filter value to zero disables filter function, and bypass setting becomes irrelevant.

Noise Filter Bypass (*bYP5*)

The meter can be programmed to filter small input changes, but allow larger input changes to be displayed immediately, by setting the bypass value accordingly.

If the input signal goes beyond the bypass value, it will be displayed immediately with no averaging done on it.

The noise filter bypass value may be set anywhere from 0.2 to 99.9. It corresponds to percentage of full scale for process inputs and to degrees Fahrenheit for temperature inputs.

Increasing the bypass value may slow down the display response to changes on the input signal.

Serial Communications (SErL)

The meter is equipped with serial communications capability as a standard feature using PDC protocol and MeterView software or using the Modbus RTU protocol. The Modbus RTU protocol is included on all models after 5/1/2010. To communicate with a computer or other data terminal equipment, an RS-232, RS-485, or USB adapter option is required; see *Ordering Information* on page 6 for details.

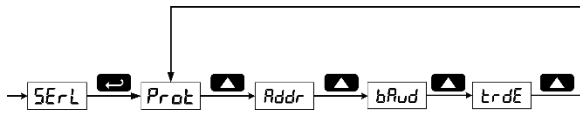

When using more than one meter in an RS-485 multi-drop mode, each meter must be provided with its own unique address. The address may be programmed from 00 to 99 for PDC protocol and from 1 to 247 for Modbus protocol. The transmit delay may be set between 0 and 199 ms (see Serial Communication Adapter manual for more details).

The Trident can also be connected directly to another Trident meter through a cable assembly (PDA7420). This allows the user to copy all the settings from one meter to another, using the *Copy* function.

Protocol Selection Menu (Prot)

The Protocol selection menu is used to select either the PDC or the Modbus protocol. PDC protocol should be selected to run MeterView software.

Select Menu (SELC)

The *Select* menu is used to select linear or square root function, display intensity, and low-flow cutoff. Selection for relay or analog output is a factory setting depending on the option installed.

- Output options are installed and set up at the factory.
- Changing the output selection will cause erroneous operation.

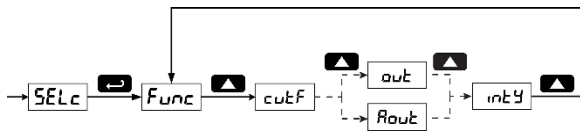

Note: Depending on meter model, the *Select* menu will display either *out* or *Aout*. In either case, the output selection menu is for factory use only. Do not attempt to change output selection.

Linear or Square Root Function (LInr or Sqrt)

Meters are set up at the factory for linear function. The linear function provides a display that is linear with respect to the input signal.

The square root function is used to linearize the signal from a differential pressure transmitter and display flow rate in engineering units.

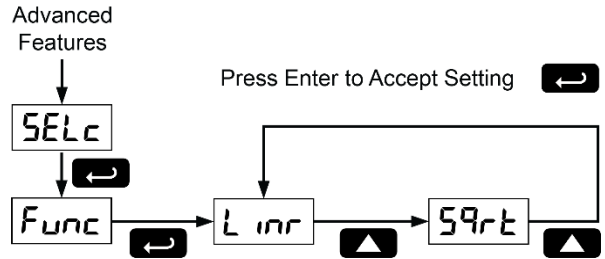

Low-Flow Cutoff (cutF)

The low-flow cutoff feature allows the meter to be programmed so that the often-unsteady output from a differential pressure transmitter, at low flow rates, always displays zero on the meter.

The cutoff value may be programmed from 0 to 9999. Below the cutoff value, the meter will display zero. Programming the cutoff value to zero disables the cutoff.

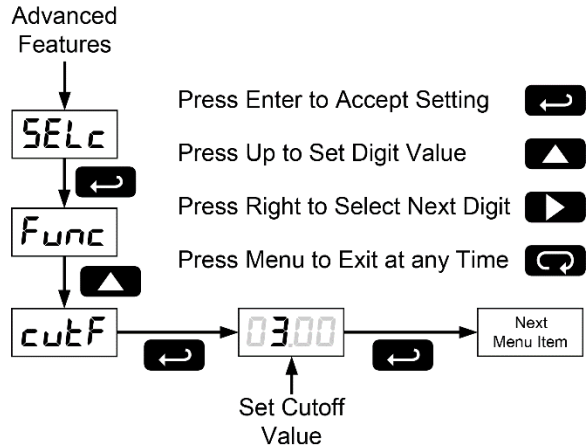

Display Intensity (intensity)

The Display Intensity function allows the selection of eight levels of intensity for various lighting conditions.

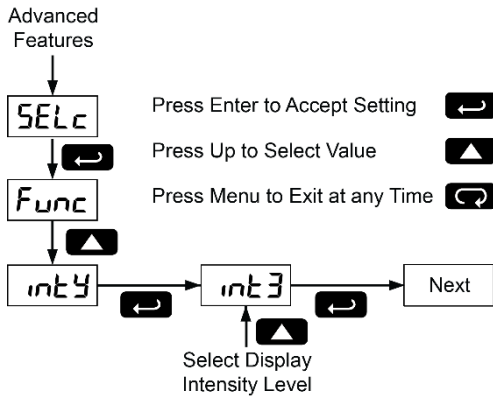

Meter Copy Function (Copy)

The Copy function is used to copy (or clone) all the settings from one meter to other meters requiring exactly the same setup and programming (i.e. type of input, scaling, decimal point, filter, bypass, etc.).

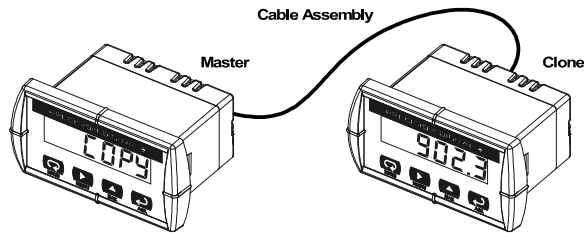

Figure 39. Meter Copy Connection

Copy Function Requirements

To successfully copy settings from one meter to another, both meters must have:

1. Same software version
2. Same baud rate setting
3. PDC protocol selected

See *Determining Software Version*, page 44 for instructions.

Meter Cloning Instructions

CAUTION

- Do not connect the two meters to the same 4-20 mA loop while cloning. Internal calibration may be affected.

1. Connect the two meters using cable assembly PDA7420 or equivalent (e.g. Digi-Key P/N H1663-07-ND). Cable should not exceed 7' (2.1 m).
2. Power up both meters. Leave Clone meter in Run Mode.
3. Enter the *Advanced Features Menu* of the Master meter, see *Advanced Features Menu*, page 32.
4. Scroll to *Copy* function using **Up** arrow button then press **Enter/Ack**.
5. The meter displays the message *SEnd*. Press **Enter/Ack**, the display flashes while sending data. The message *donE* is displayed when copying is completed.

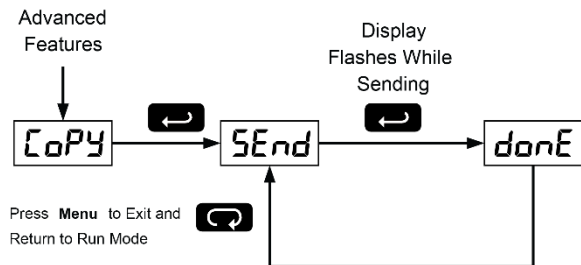

6. The Clone meter displays the memory address being programmed then the message *donE* when copying is completed. The meter initializes and returns to Run Mode using the same settings as the Master.
7. If meter to be cloned does not respond to the data being sent, refer to **Copy Function Requirements** above.

MeterView Software



Note: Trident meter is not powered from USB connection and requires external power to be programmed.

The easiest and quickest way to program your Trident meter is to use the FREE MeterView software. We will even send you a PDA8006 USB adapter, normally sold for \$47.00, at no cost if you register your meter at <http://www.predig.com/free8006> (limit one per customer). You can program the Trident meter you just bought with the front panel buttons and have the PDA8006 on hand for programming future meters.

Remote Programming

MeterView software allows all setup parameters to be programmed remotely from a PC and saved to a file for reporting or programming other meters.

Data Acquisition

MeterView software provides a convenient way to collect the data generated by the Trident Model PD765 serial output. The user can select the logging time interval. Data can be written to a file, which can then be imported into a spreadsheet or other application.

Monitoring

MeterView software can be used to monitor up to 100 Trident meters on a PC. The user can set a custom meter identification, such as Tank 1 to display on the screen as well as engineering units, such as feet. The screen shot below shows MeterView software monitoring level in six storage tanks:

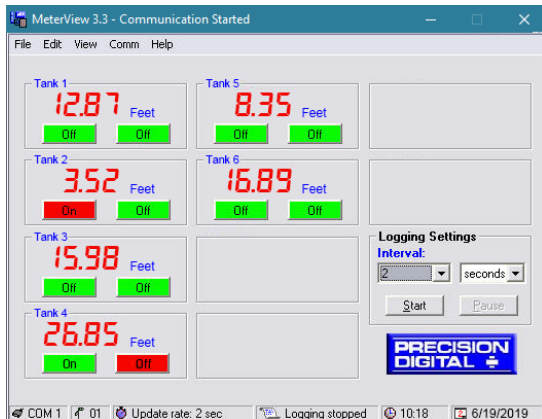

Monitoring System Parts

The following table illustrates the parts needed to monitor 10 Trident meters:

Quantity	Model	Description
10	PDA7422	Trident RS-485 Serial Adapter
1	PDA8485-I	USB to RS-485 Isolated Converter

MeterView Installation

1. Go to www.predig.com/meterview
2. Read instructions & copy serial # of desired MeterView version
3. Download Installation file to computer
4. Double-click installation file to open it
5. Double-click **Setup.exe** to begin installation
6. Follow on-screen instructions

Running MeterView the First Time

The first time MeterView is run it is necessary to set up the serial communication settings of the program. Select the communication port and the baud rate of the meter(s) connected.

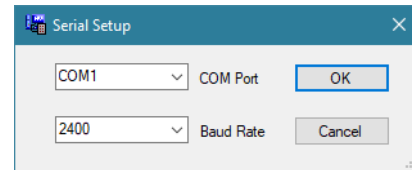

Note: The selected baud rate in MeterView and the meter(s) baud rate must be the same. Otherwise a communication error will occur.

Enable Meter and Select Meter Address

The actual meter address is set up at the meter using the front panel buttons. The location where a meter is displayed is selected on MeterView Main window.

To enable or select a meter with a different serial address:

1. Right-click on the screen location of meter.
2. Click on **Enabled**, if meter is not yet enabled.
3. Click on **Change Address**.
4. Select meter address to display in this location.

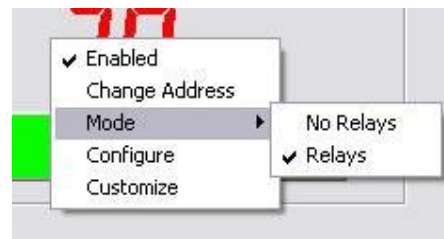

MeterView Main Window

The main MeterView window shows the present reading(s), relays/alarm status, tag number(s) and selected engineering units, along with other information for each meter. The graphic below indicates the different parts of the main MeterView window.

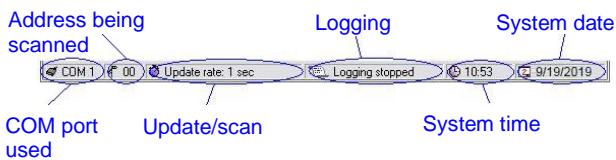
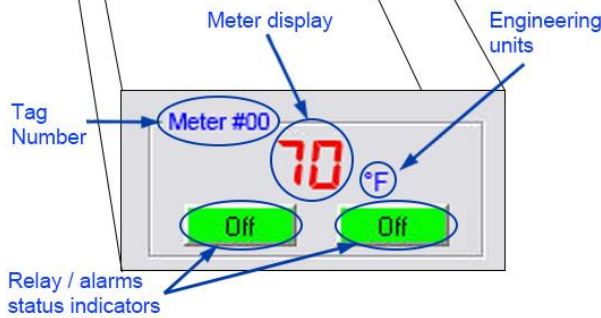
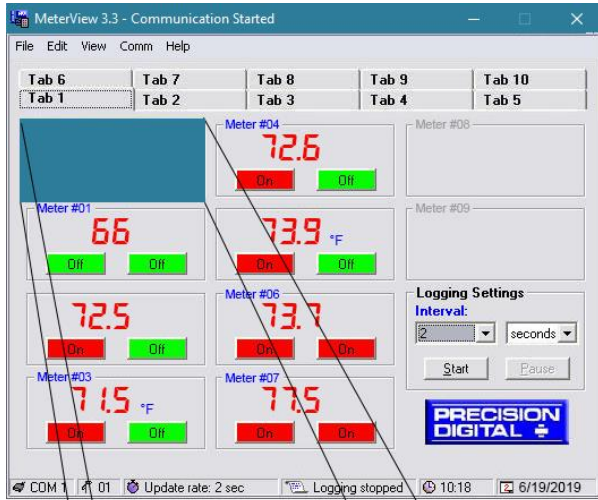

Main Window Menus

The MeterView main window contains the following menus:

- File menu
- Edit menu
- View menu
- Comm Menu
- Help Menu

File Menu

The following options are available from this menu:

1. **Exit** to close the MeterView program.

Edit Menu

The following options are available from this menu:

1. **Serial Settings** to edit the serial communication settings.
2. **Number of Meters** to automatically populate the Main Window with a single meter, 10 meters, or 100 meters.

View Menu

The following options are available from this menu:

1. **Event Log** to view the MeterView event log window where all internal program events and errors are logged.
2. **Show Relay Alerts** select whether or not MeterView should alert the user of a change in the relay status (ON → OFF or vice versa) with a pop-up message.

Comm Menu

The following options are available from this menu:

1. **Stop** to halt the automatic meter scanning. This allows quicker access to menu items, functions, and windows.
2. **Start** to resume the automatic meter scanning.

Help Menu

The following options are available from this menu:

1. **Online Resources** links to Predig.com for help and product documentation.
2. **About Meterview 3.3** for version number and build information.

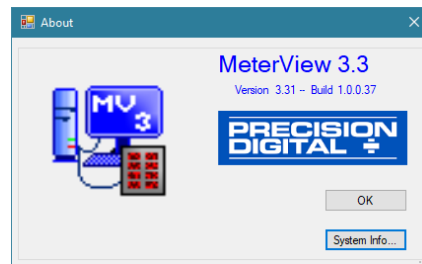

Right Click Menu

By right clicking on a meter on the screen a menu will appear with the following options:

Menu Item	Function/Submenus
Enabled	Enable or disable a meter on the screen
Change Address	Change a meter's serial address in MeterView
Mode	Show relays
Configure	Access the configuration window for a meter
Customize	Customize how a meter looks on the screen

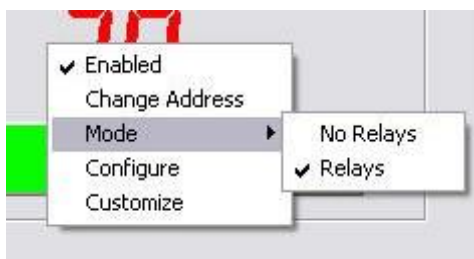

Notes:

- Accessing menus or other windows could disrupt communication with the meter(s).
- Use left mouse button or tab key on the keyboard to navigate within a window.
- Parameters not available within a window appear grayed-out.
- An arrow next to a box indicates a drop-down menu. Click on arrow to display the drop-down menu.

Configuration Window

Click on **Configure** in the right click menu to open a meter's configuration window. The following settings can be programmed from this window:

1. Input type (4-20 mA, 0-10 V, RTD, or TC).
2. Decimal point for process inputs (dd.dd).
3. Units (F or C) and sensor type for temperature inputs.
4. Values for scaling process inputs, values for scaling analog output, Password, Adjust (temperature only), Filter, Bypass, Cutoff (process inputs only), Transmit Delay, Function type, and Cut-off.
5. Relay settings.
6. After the last change has been made, click the **Write to Meter** button or press Enter on the keyboard to send the new settings to the meter, or click on **Exit** to abandon changes. Before sending the new settings, MeterView will ask to confirm that the meter's current settings should be overwritten. Click **Yes** to overwrite the settings, or **No** to abort the operation and return to the configuration window.

The configuration window contains the following menus:

- File menu
- Tools menu
- Password menu

Note:

- Accessing menus or other windows could disrupt communication with the other meter(s).

File Menu

The following options are available from the File menu:

1. **Save Configuration** to save the present settings to a file.
2. **Load Configuration** to load settings from a file.
3. **Export to HTML** to save the present settings to a HTML file.
4. **Import from HTML** to load settings from a HTML file.
5. **Print Configuration**

Tools Menu

The following options are available from the Tools menu:

1. **Load Defaults** to load the factory default settings.

It is recommended to save a configuration file before changing any setting and before any calibration operation.

Password Menu

The following options are available from the Password menu:

1. **Lock Meter** to lock the meter and prevent unauthorized changes.
2. **Unlock Meter** to unlock the meter and allow changes to be made.
3. **Change Password** to change the unlock password of the meter.

The password must be a four-digit number; "0000" is the unlocked password setting.

Input Tab

In the configuration window, click on the **Input** tab to view the input options.

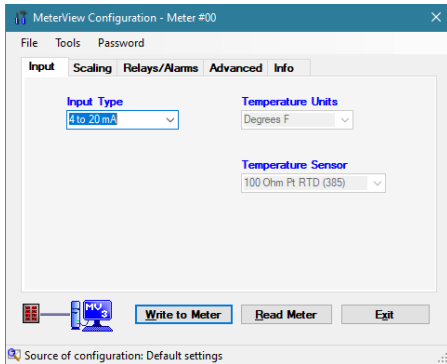

Set Up Input Type

Click on the arrow next to the *4 to 20 mA* box and then click on the desired input type.

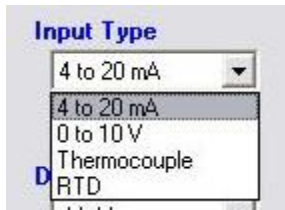

Set Up Decimal Point

Click on the arrow next to the *dd.dd* box and then click on the desired decimal point position. Decimal point selection is available for 4-20 mA and 0-10 V inputs only. The display scale and relay set/reset points are adjusted according to the decimal point selection.

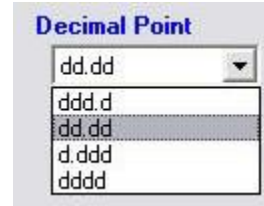

Set Up Temperature Unit

Click on the arrow next to the *Degrees F* box and then click on the desired temperature unit. Temperature unit selection is available for Thermocouple and RTD inputs only.

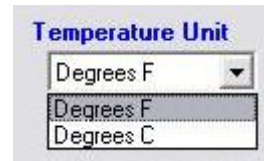

Set Up Temperature Sensor

Click on the arrow next to the *Type J* box and then click on the desired temperature sensor. Temperature sensor selection is available for Thermocouple and RTD inputs only.

Thermocouple Sensors

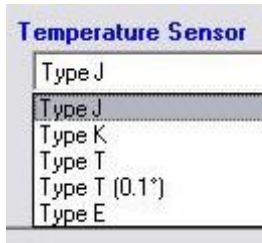

RTD Sensors

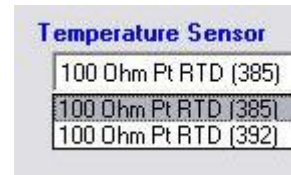

Scaling Tab

In the configuration window, click on the **Scaling** tab to view the scaling settings for process inputs (current and voltage).

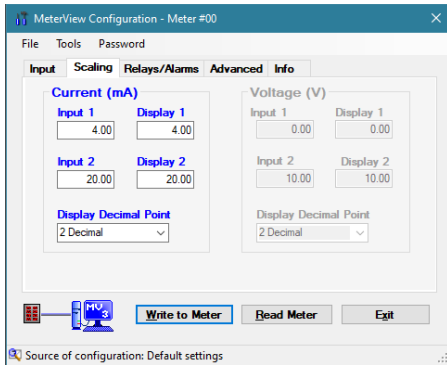

Info Tab

In the configuration window, click on the **info** tab to view the firmware number and version.

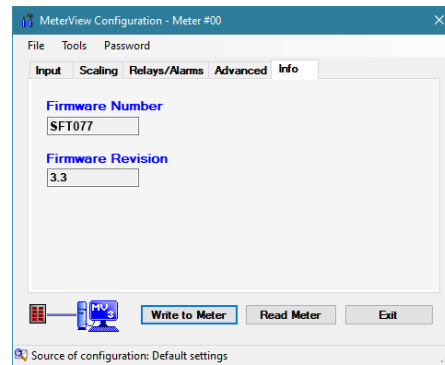

Relays/Alarms Tab

In the configuration window, click on the **Re-lays/Alarms** tab to view the settings for the re-lays/alarms.

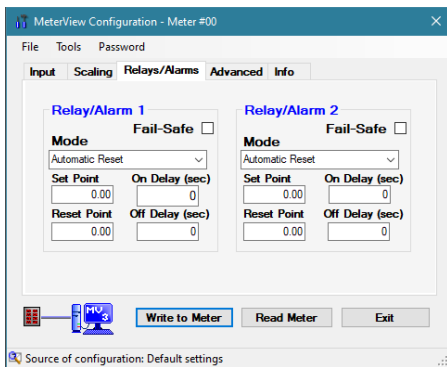

Customize Window

Click on **Customize** in the right click menu to open a meter's customize window. The following settings can be programmed from this window:

1. **Tag Number** to identify a meter and optionally display it on the meter. Pre-selected special characters may be used in this field by simply dragging the desired symbol into it.
2. **Display Units** to identify the engineering units of the value being read and optionally display it on the meter. Pre-selected special characters may be used in this field by simply dragging the desired symbol into it.
3. **Display Color** to change the color of the meter display on the screen.
4. **Relay Tag** to change the text label of the Relay Status indicator(s).
5. **Relay Color** to change the color of the Relay Status indicator(s).

Advanced Tab

In the configuration window, click on the **Advanced** tab to view the advanced settings. Consult the meter manual for further details.

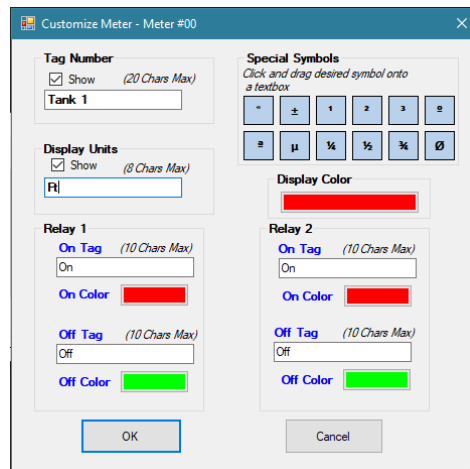
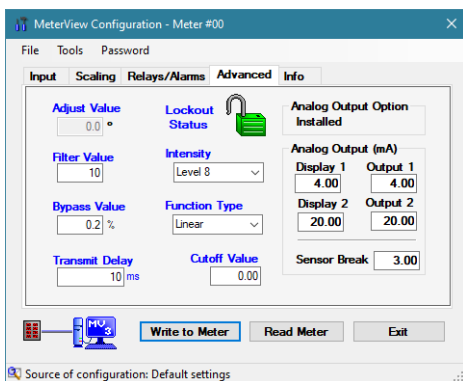

Note:

- These settings are **NOT** saved to the meter.

Serial Communication Setup

Addresses for Trident Meter and MeterView are set to 00 at the factory.

1. From the main window, click on **Edit → Serial Settings** menu to access the Serial Communication Setup.
2. Select correct communication port used for Serial Adapter.
3. If timeout error is received, try another serial port selection or check meter's address.

To change the serial address of a meter, simply click on **Change Address** in the right-click menu. This setting is on a per-meter basis.

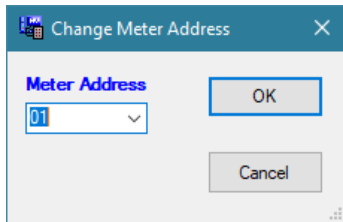

Note:

- Baud rate is set up for 2400 bps at the factory.

Relays/Alarms Status

Each meter enabled in the main MeterView window can display the current status of its relays/alarms (if the meter **Mode** in the right-click menu is set to **Relays**) and can allow the user to remotely acknowledge the relays/alarms (if applicable). The text labels and colors for the status indicators may be customized through the **Customize** window.

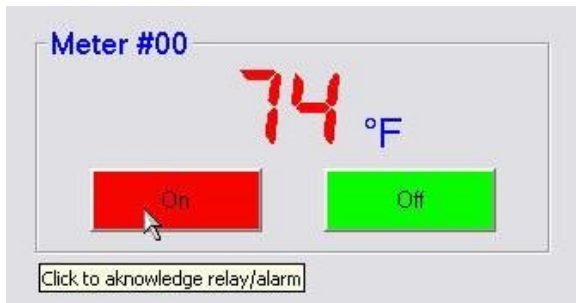

Logging Meter Data to File

1. Click on the arrow next to the Interval box to select an interval from 2 to 60 or select manual to log the data only when the **Log** button is clicked (**Log** button is only visible when manual is selected).
2. Select seconds, minutes, or hours.
3. Click the **Start** button.
4. Select file location and enter a file name. Click **OK**. MeterView will begin logging data to the file.

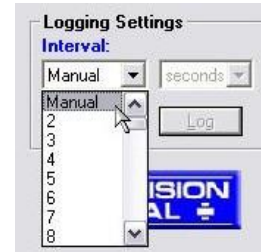

Logging may be paused or stopped at any time. MeterView will indicate logging and paused status with corresponding message flashing in the main window status bar. When logging, all other MeterView functions and windows are not accessible.

Log File Sample

The HTML log file format contains pertinent information related to the meter and logging selections. Each log entry includes date and time, tag number, serial address, display value, units and relays/alarms status.

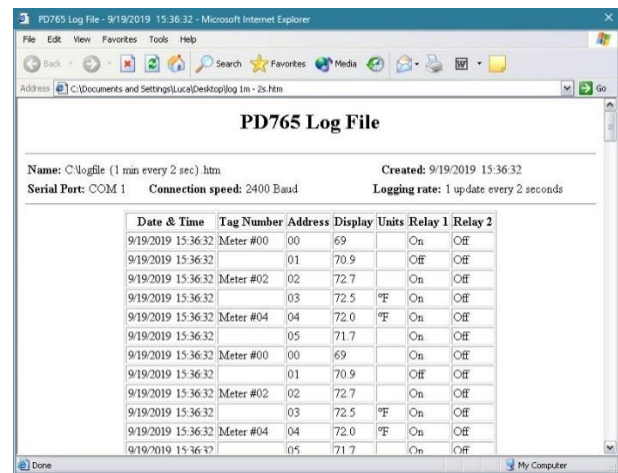

Internal Calibration (*ICAL*)

- There is **no need to recalibrate** the meter when first received from the factory.
- The meter is **factory calibrated** prior to shipment, for all input types, in milliamps, volts, and degrees respectively. The calibration equipment is certified to NIST standards.

The internal calibration allows the user to scale the meter without applying a signal. This menu is not available if the meter is set up for TC or RTD inputs.

The use of calibrated signal sources is necessary to perform the internal calibration of the meter.

Check calibration of the meter at least every 12 months. Each input type must be recalibrated separately, if meter will be used with all input types.

Notes:

- If meter is in operation and it is intended to accept only one input type (e.g. 4-20 mA), recalibration of other inputs is not necessary.
- Allow the meter to warm up for at least 30 minutes before performing the internal calibration procedure.

The *Internal calibration* menu is part of the *Advanced Features Menu*.

- 1.
2. Press the Right arrow and Menu button simultaneously or hold the Menu button for approximately 3 seconds to access the *Advanced Features Menu* of the meter.
3. Press the **Up** arrow button to scroll to the *Internal calibration* menu and press **Enter/Ack**.
4. The meter displays either current (*Curr*) or voltage (*Volt*), according to the meter input setup. Press **Enter/Ack** to start the calibration process.

Example for current input internal calibration:

5. The meter displays *Low* input current (*I Lo*). Apply the low input signal and press **Enter/Ack**. The display flashes for a moment while meter is accepting the low input.
6. After the display stops flashing, a number is displayed with the leftmost digit brighter than the rest. The bright digit is the active digit that can be changed by pressing the **Up** arrow button. Press the **Right** arrow button to move to the next digit.
7. Set the display value to correspond to the input signal being calibrated.
8. The display moves to the high input calibration (*I Hi*). Apply the high input signal and press **Enter/Ack**.
9. Set the display for the high input calibration in the same way as it was set for the low input calibration.

For instructions on how to program numeric values see *Setting Numeric Values*, page 23.

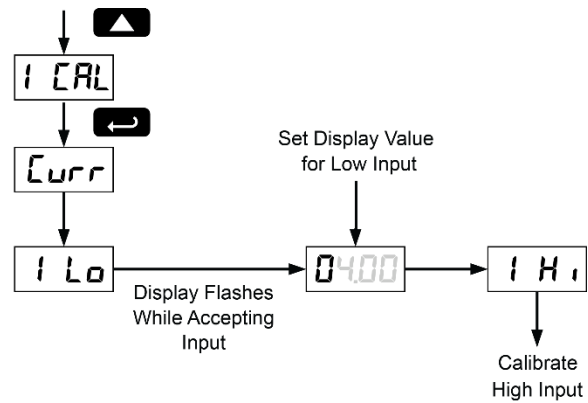

The graphic above shows the calibration of the current input. The voltage input is calibrated in a similar way.

Tips:

- Low and high input signals can be any valid values within the range of the meter.
- Observe minimum input span requirements between input 1 and input 2.
- Low input must be less than high input signal.

Error Message (*Err*)

An error message indicates that the calibration or scaling process was not successful. After the error message is displayed, the meter reverts to input 1, allowing the appropriate input signals to be applied.

The error message might be caused by any of the following conditions:

1. Input signal is not connected to the proper terminals, or it is connected backwards.
2. Wrong signal selection in *Setup* menu.
3. Minimum input span requirements not maintained.

Minimum Input Span

The minimum input span is the minimum difference between input 1 and input 2 signals required to complete the calibration or scaling of the meter.





Input range	Input 1 & input 2 span
4-20 mA	0.40 mA
±10 VDC	0.20 VDC

Operation

For process inputs, the meter is capable of accepting positive and negative signals and displaying these signals in engineering units from -1999 to 9999 (e.g. a signal from -10 to +10 VDC could be displayed as -10.00 to 10.00).

The temperature inputs are displayed according to the input type and temperature units (°F or °C) selected. RTD and Type T thermocouple inputs can be displayed with either 1° or 0.1° resolution.





Front Panel Buttons Operation

Button Symbol	Description
	Press to enter or exit Programming Mode, view settings, or exit Max/Min readings Hold to enter <i>Advanced</i>
	Press to reset Max/Min readings
	Press to display Max/Min readings alternately
	Press to display Max/Min reading indefinitely while displaying Max/Min Press ACK to acknowledge relays

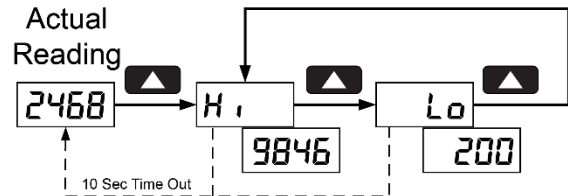
Maximum/Minimum Readings

The main function of the front panel buttons during operation is to display the maximum and minimum readings reached by the process or temperature inputs.



-  Press **Up** to Display and to Toggle Between Max/Min
-  Press **Enter** to Hold Max/Min
-  Press **Right** to Reset Max/Min
-  Press **Menu** to Exit Max/Min

1. Press **Up** arrow/**Max** button to display maximum reading since the last reset/power-up.
2. Press **Up** arrow/**Max** again to display the minimum reading since the last reset/power-up.
3. Press **Enter/Ack** to hold Max/Min display reading, the meter will continue to track new Max/Min readings.
4. If **Enter/Ack** is not pressed, the Max/Min display reading will time out after ten seconds and the meter will return to display the actual reading.
5. Press **Right** arrow/**Reset** button to reset Max/Min while reading is being displayed. Max/Min display readings are reset to actual reading.

Remote Operation of Trident X2 Front Panel Buttons

The Trident PD765 X2's four programming and operations buttons can be remotely controlled for performing such remote actions as resetting relays, viewing and resetting max / min readings and programming the meter. The [PDA2364-MRUE](#) 4-button control station accessory as shown in the diagram below is a convenient device for operating the buttons remotely.

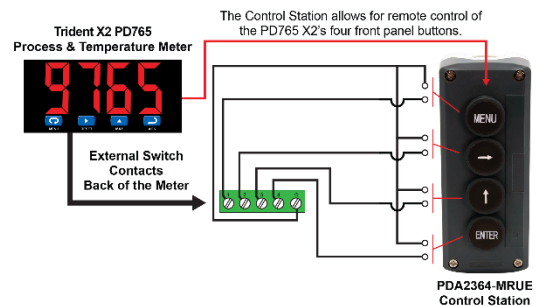

Troubleshooting

For an *Interactive Virtual Meter Demo* visit predig.com/tvm

Due to the many features and functions of the meter, it's possible that the setup of the meter does not agree with what an operator expects to see. If the meter is not working as expected, refer to the *Diagnostics* menu and consult the recommendations described below.

It may also be helpful to program the meter using MeterView software. A [free USB adapter](#) can be sent to you if you register your meter.

Diagnostics Menu (d ,RG)

The *Diagnostics* menu is located in the *Advanced Features Menu*, to access *Diagnostics* menu see *Advanced Features Menu*, page 32.

It provides an easy way to view the programmed parameter settings for troubleshooting purposes. Press the **Enter/Ack** button to view the settings and the **Menu** button to exit at any time.

For a description of the diagnostics messages see *Advanced Features Menu & Display Messages*, page 32.

Determining Software Version

To determine the software version of a meter:

1. Go to the *Diagnostics* menu (d ,RG) and press **Enter/Ack** button.
2. Press **Up** arrow/**Max** button and scroll to Information menu (InF d).
3. Press **Enter/Ack** to access the software number (SFt), version (uEr). Write down the information as it is displayed. Continue pressing **Enter/Ack** until all the information is displayed.

Reset Meter to Factory Defaults

When the parameters have been changed in a way that is difficult to determine what's happening, it might be better to start the setup process from the factory defaults.

Instructions to load factory defaults:

1. Enter the *Advanced Features Menu*. See *Advanced Features Menu*, page 32.
2. Press **Up** arrow to go to *Diagnostics* menu
3. Press and hold **Right** arrow/Reset for five seconds, press **Enter/Ack** when display flashes rSEt.
Note: If **Enter/Ack** is not pressed within three seconds, display returns to *Diagnostics* menu.
4. The meter goes through an initialization sequence (same as on power-up) and loads the factory default settings.

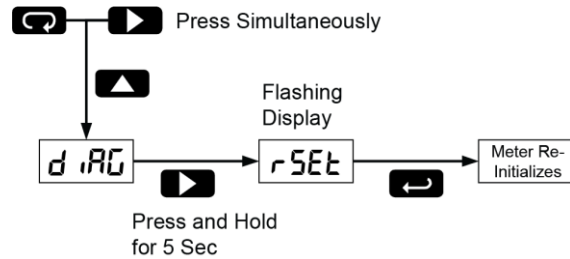

Factory Defaults & User Settings

The following table shows the factory setting for most of the programmable parameters on the meter. Next to the factory setting, the user may record the new setting for the particular application. MeterView software allows the saving of all meter parameters to a file for restoring meter settings, reporting, and copying settings to other meters.

Model: _____ S/N: _____
 Date: _____

Parameter	Display	Default Setting	User Setting
Input type	inPt	4-20 mA	
Decimal point	dddd	2 places	
Programming	Prog		
Input 1	inP1	4.00 mA	
Display 1	d.51	4.00	
Input 2	inP2	20.00 mA	
Display 2	d.52	20.00	
Relay 1	rLY1		
Action 1	Act1	Automatic	
Set 1	SEt1	7.00	
Reset 1	r5t1	6.00	
Relay 2	rLY2		
Action 2	Act2	Automatic	
Set 2	SEt2	10.00	
Reset 2	r5t2	9.00	
Fail-safe	FLSF		
Fail-safe 1	FLS1	Off	
Fail-safe 2	FLS2	Off	
Time delay	dLAY		
On delay 1	On1	0 sec	
Off delay 1	OFF1	0 sec	
On delay 2	On2	0 sec	
Off delay 2	OFF2	0 sec	

Parameter	Display	Default Setting	User Setting
Break 1	brH1	Off	
Break 2	brH2	Off	
Password	PRSS	0000 (unlocked)	
Advanced Features	N/A		
Adjust	Adj	0.0° (temp only)	
Filter	FLtr	10	
Bypass	bYPS	0.2	
Serial settings	SErL		
Protocol	PdC	PDC protocol	
Address	Addr	00	
Baud rate	bAud	2400	
Trans delay	trdE	10 ms	
Function	Func	Linear	
Cutoff value	CutF	0.00 (disabled)	
Output option	out/Rout	Factory set only	
Display intensity	intY	Level 8	
Modbus defaults	N/A		
Address	Addr	247	
Parity	Prty	Even	
Byte-to-byte timeout*	tbyt	0.01 sec	

**Note:
 The byte-to-byte timeout setting might be updated automatically depending on the baud rate selected and the previous timeout setting. The minimum timeout allowed is saved to memory if a lower value is entered (e.g. If user enters 0.00 with a baud rate of 300, 0.06 is saved)*

Troubleshooting Tips

This meter is a highly sophisticated instrument with an extensive list of features and capabilities. If the front panel buttons are used to program the meter, it may be a difficult task to keep everything straight. That is why we strongly recommend the use of the MeterView software for all programming activities. A [free USB adapter](#) is available for programming with MeterView software if you register your meter.

Symptom	Check/Action
No display at all	Check power at power connector
Not able to change setup or programming, <i>LoCd</i> is displayed	Meter is locked, enter correct four-digit password to unlock
Meter does not respond to input change	If a Low-Flow Cutoff Value has been programmed, the meter will display zero below that point, regardless of the input – which can appear like the meter is not responding to an input change. Check to make sure the problem is not being caused by an undesired low-flow cutoff value.
Meter displays error message during calibration (<i>Err</i>)	Check: <ol style="list-style-type: none"> 1. Signal connections 2. Input selected in <i>Setup</i> menu 3. Minimum input span requirements
Meter displays <ul style="list-style-type: none"> • <i>oPEr</i> • <i>9999</i> • <i>- 1999</i> • Displays negative number, not responding to RTD. 	Check: <ol style="list-style-type: none"> 1. Input selected in <i>Setup</i> menu 2. TC/RTD Switch position 3. Corresponding signal at Signal connector
Display alternates between <ol style="list-style-type: none"> 1. <i>H i</i> and a number 2. <i>Lo</i> and a number 	Press Menu to exit Max/Min display readings.
Display response is too slow	Check filter and bypass values
Inaccurate temperature reading	Check: <ol style="list-style-type: none"> 1. Temperature units (°F or °C) 2. TC type or RTD curve selected 3. Offset adjustment 4. TC wire used 5. Calibration
If the display locks up or the meter does not respond at all	Cycle the power to restart the microprocessor.
Relay operation is reversed	Check: <ol style="list-style-type: none"> 1. Fail-safe in <i>Setup</i> menu 2. Wiring of relay contacts
Relay and status LED do not respond to signal	Check: <ol style="list-style-type: none"> 1. Relay action in <i>Setup</i> menu 2. Set and reset points
Meter not communicating with MeterView or other programs	Check: <ol style="list-style-type: none"> 1. Serial adapter and cable 2. Serial protocol selected 3. Meter address and baud rate 4. MeterView address and baud rate

Quick Interface Reference Guide

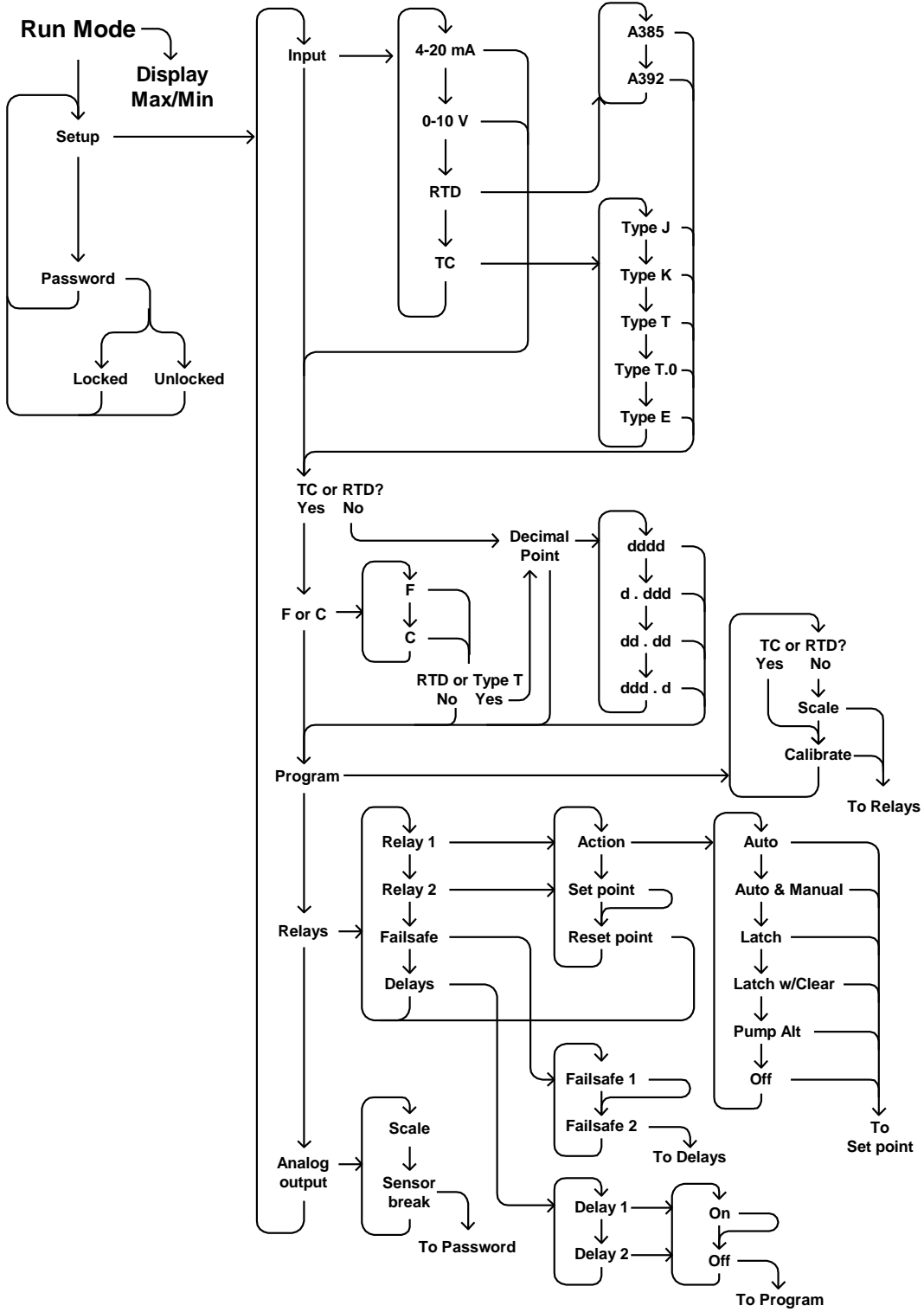

Pushbutton	Function
Menu	Go to Programming Mode or leave Programming, Advanced Features, and Max/Min Modes.
Right Arrow	Move to next digit.
Up Arrow	Move to next selection or increment digit.
Enter/Ack	Accept selection/value and move to next selection.

Right Arrow & Menu simultaneously enters Advanced Features

Max/Min Mode

While in Run Mode, pressing **Up Arrow** will initiate Max/Min Mode. **Up Arrow** toggles between Max & Min displays, and **Right Arrow** resets the Max/Min to the current value. Press **Menu** or wait 10 seconds to return to Run Mode. Pressing **Enter/Ack** will disable the 10 second timeout and continuously display Max or Min.

Press **Right arrow** and **Menu** to access Advanced Features Menu

When the meter is locked, Adjust, Filter and Bypass can only display their settings, and the Copy and ICAL functions are not available.

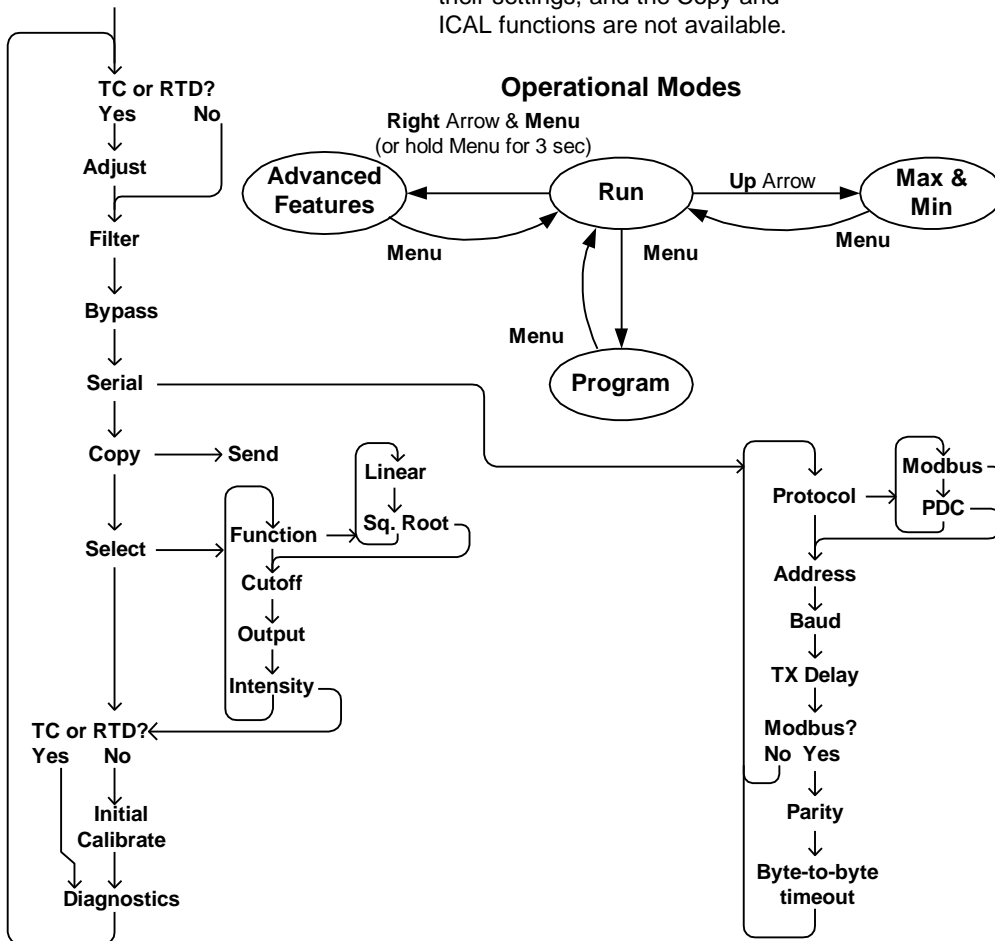

Contact Precision Digital

Technical Support

Call: (800) 610-5239 or (508) 655-7300

Email: support@predig.com

Sales Support

Call: (800) 343-1001 or (508) 655-7300

Email: sales@predig.com

Place Orders

Email: orders@predig.com

For the latest version of this manual please visit

www.predig.com

PRECISION DIGITAL CORPORATION

233 South Street • Hopkinton MA 01748 USA

Tel (800) 343-1001 • (508) 655-7300

www.predig.com

