

ScopiX IV
OX 9062
OX 9102
OX 9104
OX 9304













DIGITAL OSCILLOSCOPES

- 60MHz, 2 isolated channels
- 100MHz, 2 isolated channels
- 100MHz, 4 isolated channels
- 300MHz, 4 isolated channels

Thank you for purchasing a **ScopiX IV digital oscilloscope with isolated channels**.

For best results from your instrument:

- **Read** this user manual carefully
- **Observe** the precautions for use

	WARNING, risk of DANGER! Refer to these instructions whenever this danger symbol appears.		In the European Union, this product is subject to selective collection and recycling at end-of-life as waste electric and electronic equipment under directive 2002/96/EC (WEEE): this equipment must not be treated as an ordinary household waste. Spent batteries must not be treated as ordinary household waste. Take them to the appropriate collection point for recycling.
	Indoor use.		
	Instrument entirely protected by double insulation.		Earth terminal.
	Chauvin Arnoux has adopted an Eco-Design approach in designing this instrument. Analysis of the complete lifecycle has enabled us to control and optimize the effects of the product on the environment. In particular this instrument exceeds regulation requirements with respect to recycling and reuse.		Risk of electric shocks: instructions for connecting and disconnecting the inputs. Always connect the probes or adapters to the instrument before connecting them to the measurement points. Always disconnect the probes or leads from the measurement points before disconnecting them from the instrument. These instructions apply before cleaning the instrument and before opening the cover on the battery compartment and the probe calibration outputs.
	The product is declared recyclable following an analysis of the life cycle in accordance with standard ISO 14040.		
	The CE marking indicates conformity with European directives, in particular LVD and EMC.		Application or withdrawal not authorized on conductors carrying dangerous voltages. Type B current sensor as per EN 61010-2-032.

Definition of measurement categories:

Measurement category IV corresponds to measurements taken at the source of low-voltage installations.

 Example: power feeders, counters and protection devices.

Measurement category III corresponds to measurements on building installations.

 Example: distribution panel, circuit-breakers, machines or fixed industrial devices.

Measurement category II corresponds to measurements taken on circuits directly connected to low-voltage installations.

 Example: power supply to electro-domestic devices and portable tools.

PRECAUTIONS FOR USE

This instrument and its accessories comply with safety standards EN61010-1, EN61010-031, and EN61010-2-032, at voltages that depend on the accessories (600V CAT III with respect to earth whatever the accessory) at an altitude of less than 6500' (2,000m), indoors, with a degree of pollution ≤2.

Failure to observe the safety instructions may result in electric shock, fire, explosion, and destruction of the instrument and of the installations.

- The operator and/or the responsible authority must carefully read and clearly understand the various precautions to be taken in use. Sound knowledge and a keen awareness of electrical hazards are essential when using this instrument.
- If you use this instrument other than as specified, the protection it provides may be compromised, thereby endangering you.
- Do not use your instrument on networks of which the voltage or category exceeds those stated.
- Do not use the instrument if it seems to be damaged, incomplete, or poorly close.
- Before each use, check the condition of the insulation on the leads, housing, and accessories. Any item of which the insulation is deteriorated (even partially) must be set aside for repair or scrapping.
- Use only the leads and accessories supplied. The use of leads (or accessories) of a lower voltage rating or category limits the use of the combined instrument + leads (or accessories) to the lowest category and service voltage.
- Use personal protection equipment systematically.
- When handling the leads, test probes, and crocodile clips, keep your fingers behind the physical guard.
- All troubleshooting and metrological checks must be done by competent, accredited personnel.

CONTENTS

1. GENERAL	4
1.1. Introduction	4
1.2. Delivery condition	4
1.2.1. Unpacking, re-packing.....	4
1.2.2. Supply	4
1.3. Accessories	5
1.4. Battery and power supply	6
1.4.1. LITHIUM-ION battery.....	7
1.4.2. Charging the battery	7
1.5. Isolation of the channels	8
1.6. Probix accessories	9
1.6.1. Probixt	9
1.6.2. Rapid, error-free measurements.....	9
1.6.3. Auto scale.....	10
1.6.4. Safety message.....	10
1.6.5. Power supply to the accessories	10
2. DESCRIPTION	11
2.1. Front panel	11
2.2. Rear panel	11
2.3. Touch screen and stylus	12
2.4. Accessories	13
2.5. Communication interfaces	15
3. GETTING STARTED	16
3.1 General principles	16
3.2 ON/OFF key	16
3.3 Screenshot key	16
3.4 Full Screen key	16
3.5 HOME key and icon	17
3.6 Brightness key	17
4. OX 9304 FUNCTIONAL DESCRIPTION	18
4.1 SCOPE mode	18
4.1.1 Keys/ active keypad.....	18
4.1.2 Reference Memory adjustment.....	18
4.1.3 AUTOSET adjustment → "Magic Wand" key....	18
4.1.4 MEASURE adjustment	19
4.1.5 HORIZONTAL time base adjustment	19
4.1.6 VERTICAL signal amplitude adjustment	24
4.1.7. TRIGGER adjustment.....	26
4.1.8. MATHEMATICAL function (from screen).....	31
4.1.9. PASS/FAIL function (from screen).....	32
4.1.10. AUTOMATIC measurements (from screen).....	32
4.1.11. Backup.....	35
4.2 Multimeter mode	36
4.2.1 Keys/keyboard active in Multimeter mode	36
4.2.2 Icon/screen of the Multimeter mode	37
4.2.3 Adjustments of the VERTICAL menu	38
4.2.4. Power measurement	39
4.3 LOGGER mode	38
4.3.1 Keys/keyboard active in LOGGER mode	38
4.3.2 Icons/screen in LOGGER mode	39
4.3.3 Principles.....	39
4.4 VIEWER mode	42
4.5 HARMONIC mode	45
4.5.1. Keys/keyboard active in Harmonic mode	45
4.5.2. Principle.....	45
4.5.3. Icons/screen in Harmonic mode	46
4.6. Communication	47
4.6.1 General parameters.....	46
4.7. Memory	48
4.8 Firmware Update	49
4.9. ScopeNet IV	52
5. WAVEFORMS DISPLAY	54
5.1 Manual display	54
5.1.1. Using the keypad.....	54
5.1.2. Using the touch screen.....	55
5.2 Autiset	55
5.3 Calibrating the probes	56
5.4 Auto/Cursors/Zoom measurement	56
5.4.1. Auto.....	56
5.4.2. Cursors.....	57
5.4.3. Zoom.....	57
5.5 Adjusting the Trigger	58
5.6 Mathematical/FFT/XY measurement	58
6. MULTIMETER MEASUREMENTS	62
6.1 Differentiating channels	62
6.2 Measurement type	62
6.3 Power measurement	63
6.4 LOGGER mode	64
7. HARMONICS ANALYSIS	65
8. TECHNICAL SPECIFICATIONS	66
8.1. Oscilloscope function	66
8.2 Multimeter and LOGGER function	72
8.3 VIEWER function	74
8.4 HARMONIC ANALYSIS function	75
8.5. Communication	76
8.5.1. Communication port and peripherals.....	76
8.5.2. Applications.....	76
9. GENERAL SPECIFICATIONS	75
9.1. Nominal range of use	75
9.1.1. Environmental conditions	75
9.1.2. Variations in the nominal range of use	75
9.1.3. Power supply.....	75
9.2. Mechanical specifications	76
9.2.1. Case covered with elastomer	76
9.2.2. Mechanical conditions	76
9.3. Electrical specifications	76
9.3.1. Battery power supply.....	76
9.3.2. Line power.....	77
9.4. CEM and safety	77
9.4.1. Electromagnetic compatibility	77
9.4.2. Electrical safety	77
9.4.3. Temperature.....	78
10. MAINTENANCE	79
10.1. Warranty	79
10.2. Cleaning	79
10.3. Repair and metrological verification	79

1. GENERAL

1.1. Introduction

Your oscilloscope belongs to the **ScopiX** line of instruments; **this user manual describes the operation of an OX 9304:**

OX 9062 (Cat #2150.31)	digital	color	2 isolated channels	60MHz	scale 2.5GS/s
OX 9102 (Cat #2150.32)	digital	color	2 isolated channels	100MHz	scale 2.5GS/s
OX 9104 (Cat #2150.33)	digital	color	4 isolated channels	100MHz	scale 2.5GS/s
OX 9304 (Cat #2150.34)	digital	color	4 isolated channels	300MHz	scale 2.5GS/s

These instruments provide the following functional modes:

- oscilloscope
- multimeter
- logger
- harmonic analyzer

The interface is user-friendly: simple, compact, and practical. The **Probix** accessories ensure safety and speed, because they are recognized automatically when connected. The means of communication and storage are optimized.

1.2. Delivery condition

1.2.1. Unpacking, re-packing

The mechanical and electrical condition of the instrument was checked before shipment. When you receive it, perform a quick check for damage that may have occurred in transit. Should there be any, contact our sales department immediately and inform the carrier. For reshipping, we suggest using the original packaging.

1.2.2. Supply

Reference (Cat #)	Designation	OX 9062 2x60MHz (2150.31)	OX 9102 2x100MHz (2150.32)	OX 9104 4x100MHz (2150.33)	OX 9304 4x300MHz (2150.34)
(2152.05)	Set of 2, 5 ft. color-coded leads, test probes & alligator clips	1	1	1	1
	Probe tips 4mm in diameter	1	1	1	1
(2136.80)	10 ft USB cable	1	1	1	1
HX0179*	μSD memory card, HC, 8GB + SD	1	1	1	1
HX0033 (2124.76)	PROBIX Banana Plug (4mm) Adapter	1	1	1	1
HX0130 (2157.02)	1/10 500MHz probe, 300V CAT III				4
HX0030C (2157.03)	1/10 250MHz probe 600V CAT III	2	2	4	
HX0120 (5000.86)	METRIX carrying case	1	1	1	1
HX0121 (5000.17)	One stylus pen	1	1	1	1
HX0122 (5000.87)	Carrying strap	1	1	1	1
(2960.47)	LI-ION 5.8 Ah battery pack	1	1	1	1
(5000.85)	Replacement power adapter PA40W-2 for OX9000 series	1	1	1	1
(5000.22)	Power cord 110V (Razor Plug) for OX III % IV oscilloscopes	1	1	1	1





*Replacement μSD cards can be purchased at most retail electronics outlets.

1.3. Accessories

Reference (Cat #)		Terminations								Range of use	Types of measurement
		Probe	BNC adapter	Banana adapter	Current Clamp	Amp FLEX sensor	Mini Amp FLEX SK1-20	SK1-19 sensors	SP10-13 sensors		
HX0130 (2157.02)		✓								300V CAT III 500MHz	Voltage
HX0030C (2157.03)		✓								600V CAT III 250MHz	Voltage
HX0031 (2124.74)			✓							300V CAT III 250MHz	Voltage
HX0032 (2124.75)	50Ω		✓							30V 250MHz	Voltage
HX0033 (2124.76)				✓						300V CAT III	Voltage Resistance Capacitance Diode tester
HX0093 (2157.01)				✓						600V CAT III Filter 300Hz	Voltage
HX0034B (2124.77)					✓					0.2-60Arms 1MHz AC/DC	Current
HX0072 (2124.91)						✓				5-3000Arms 200kHz AC	Current
HX0073 (2124.92)							✓			1-300Arms 3MHz AC	Current
HX0094 (2157.03)				✓						4-20mA	%
HX0096 (2157.04)			✓							100mV/A	Courant
HX0035B (2124.78)								✓		from 14 to 2282°F (-10° to +1250°C)	Temp. K thermocouple
HX0036 (2157.05)									✓	from 212 to 932°F (100 to 500°C)	Temp. Probe PT-100

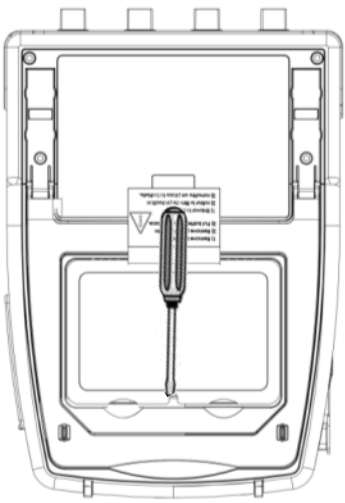
1.4. Battery and power supply

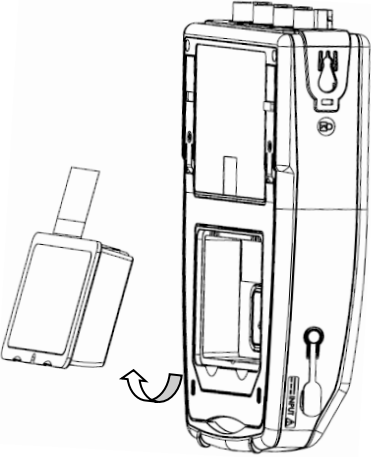
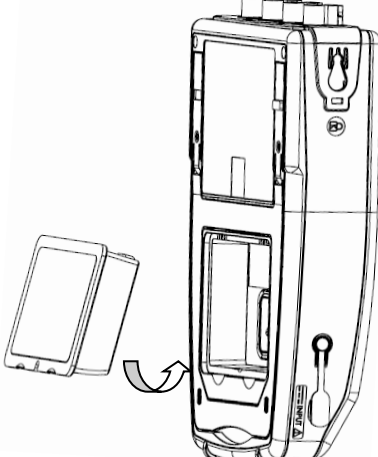
The instrument is powered by a rechargeable 10.8V, Lithium-Ion battery pack. Fully charge the battery before first use. Charging must be performed between 32 to 113°F (0 to 45°C).

<p>AC supply battery</p>	<p>1. Using a screwdriver:</p> 	<p>2. Withdraw the battery pack:</p> 
	<p>3. In the compartment, remove the protective plastic film before the first use:</p> 	<p>4. Put the battery pack back in place.</p> 
<p>Replacing the battery</p>	<p>The instrument battery includes specific protection and safety elements. Replacement of the battery by a product other than the one specified may cause material damage and bodily injury by explosion or fire.</p>	
<p>Replacement procedure</p>	<ol style="list-style-type: none"> 1. Disconnect all leads, probes, etc. from the instrument and turn it OFF. 2. Turn the instrument over and insert a screwdriver in the slot in the battery pack. 3. Push the screwdriver towards the rear; the battery will be pushed out of its compartment. In the absence of the battery, the internal clock of the instrument continues to operate for at least 60 minutes. 4. Insert the new pack in the compartment and press it firmly in place. 	
	<p>To ensure safety, replace the battery only by the original model. Do not use a battery with a damaged package.</p>	

1.4.1. LITHIUM-ION battery

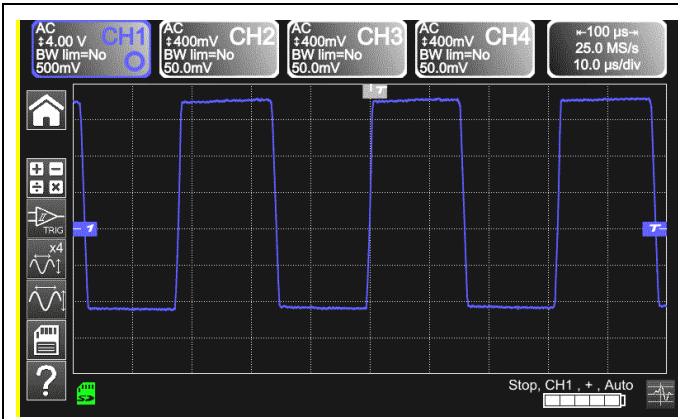

<p>Li-ion battery advantages</p>	<ul style="list-style-type: none"> ■ Long life between charges with limited bulk and weight ■ No memory effect: you can recharge the battery even if it is not fully discharged without reducing its capacity ■ Very low self-discharge ■ Rapid recharging ■ Protection of the environment, ensured by the absence of polluting materials such as lead and cadmium
---	---

1.4.2. Charging the battery



Before first use, fully charge the battery. Perform the charging between 32 and 113°F (0 and 45°C). The instrument is designed to operate with the charger connected. The charger includes two elements: a power supply and a charger. The charger simultaneously manages the charging current, the battery voltage, and the battery's internal temperature. This optimizes charging while ensuring long battery life.

Display, in each mode, of the **5 charge levels** of the battery

<p>Before using instrument, check its charge level</p> 	<ul style="list-style-type: none"> ■ Charger LED orange and blinking: no battery or battery being charged. The LED appears green at the end of charging. ■ Battery level indicator displays fewer than three bars: start charging the instrument. Charging typically takes about five hours. After prolonged storage, the battery may be completely discharged. In this case, the first charge may take longer. If the instrument is not likely to be used for more than two months, remove the battery. To maintain its capacity, recharge it every 4 to 6 months.
<p>To extend battery life:</p>	<ul style="list-style-type: none"> ■ Only use the charger provided with your instrument. Using another charger may be dangerous! ■ Charge your instrument only between 32 and 113°F (0 and 45°C). ■ Observe the conditions of use and storage stated in this user manual. ■ If the instrument will not be used for an extended period, remove the battery and store it at room temperature.
<p>Battery dock External Li-Ion charging support P01102130 + label</p>	<ul style="list-style-type: none"> ■ The charger is common to several Chauvin Arnoux instruments; the label of the PA40W-2 power supply bears the CHAUVIN ARNOUX logo. ■ This PA40W-2 charger is compatible with the ScopiX. A set of labels is provided, for "personalizing" ScopiX accessories.
	<p>Depleted batteries must not be treated as household wastes. Take them to the appropriate collection point for recycling.</p>

1.5. Isolation of the channels

ScopiX has 2 or 4 channels that are isolated from each other and from earth (600V CAT III):

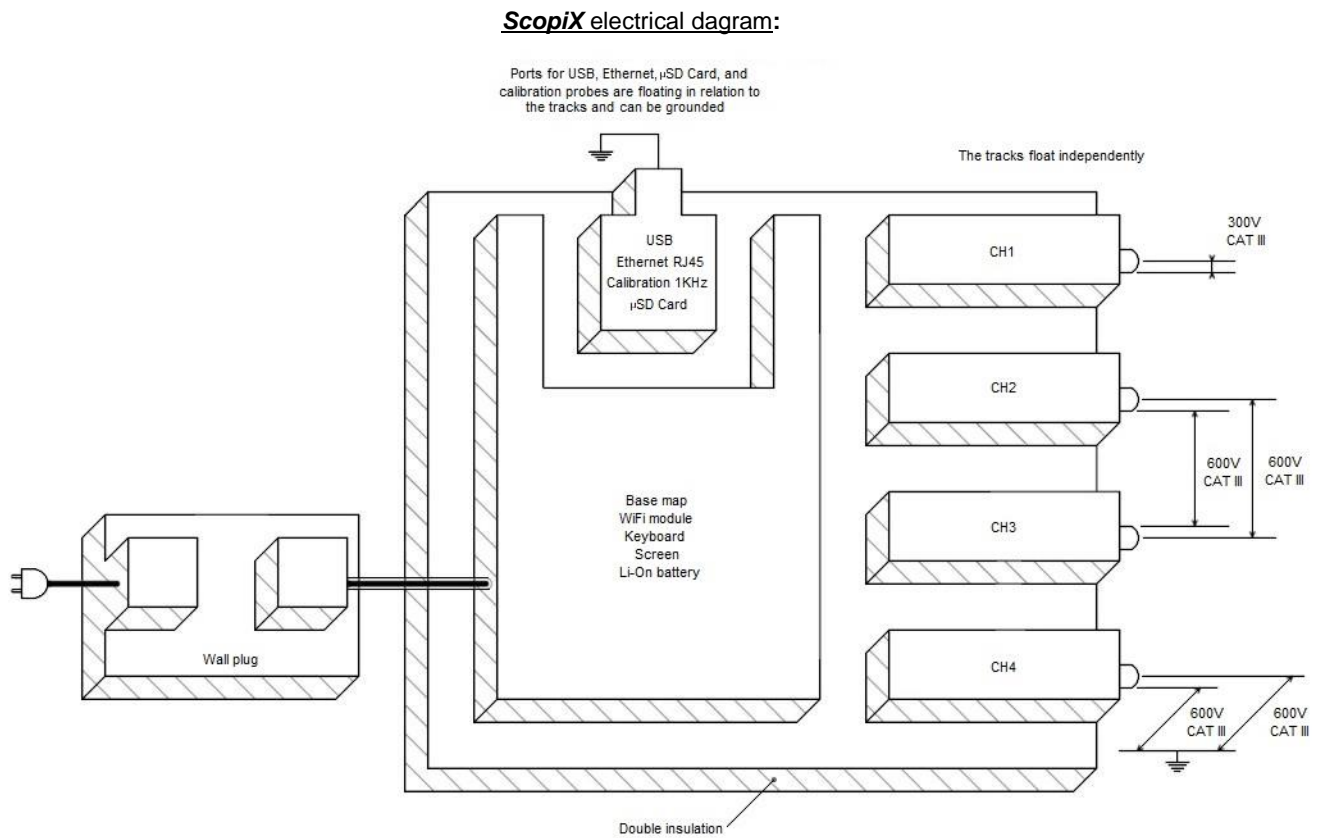

Frame grounds isolation

- Making measurements in systems where the circuits may be at different potentials can be very dangerous, due to short-circuits via the instrument or from the potentials themselves.
- The digital isolation of the grounds uses the same input terminals and acquisition systems for the oscilloscope and multimeter modes, making it possible to change from one instrument to the other without changing the measurement connection.
- Since the 3 channels are isolated from each other, you can safely set up one or two channels with a voltage-to-ground output and the other channel(s) with low current or voltage input.
- ***ProbiX*** accessories provide continuous information about the limits of the instrument (insulation voltage, rated maximum voltage).

1.6. Probix accessories

1.6.1. Probix



ScopiX uses **Probix** intelligent probes and sensors, which are recognized automatically when connected. When a probe or sensor is connected to the oscilloscope, a safety message about the probe/sensor indicates:

- maximum input voltage as a function of the category
- maximum voltage with respect to earth as a function of the category
- maximum voltage between channels as a function of the category
- sensor/probe type
- elementary specifications
- suitable safety leads

For the safety of both you and the instrument, read and carefully follow this information.

The trace color of the signal measured with a given accessory is set in the menu: "Green" → "chX" → "Probix". An interchangeable elastic or plastic ring is used to associate the color of the probe and the color of the trace. Scaling and units are configured automatically by the **Probix** system, allowing rapid measurements with no risk of error.

1.6.2. Rapid, error-free measurements

The **Probix** system ensures rapid and error-free setting up of the instrument, which is essential for instruments used for troubleshooting. Standard BNC accessories and banana cables can be connected using the safety adapters provided. An interchangeable plastic ring is used to match the color of the accessory to its channel. The power supply for the sensors is provided by the oscilloscope.

	(1)	(2)	(3)
	Input:	Floating:	Between channels:
CH1	-	600 V CAT III 600 V CAT III	600 V CAT III
HX34 - AC/DC Current 80 Apeak 1.5 % -3 dB@1 MHz 8 Amax@500 kHz			
CH2	300 V CAT III	600 V CAT III 600 V CAT III	600 V CAT III
HX31 - BNC Adapter >30 V CAT I, Use isolated rated BNC leads			
CH3	300 V CAT III	600 V CAT III 600 V CAT III	600 V CAT III
HX31 - BNC Adapter >30 V CAT I, Use isolated rated BNC leads			
CH4	300 V CAT III	600 V CAT III 600 V CAT III	600 V CAT III
HX30 - 1/10 Probe 250 MHz Bandwidth, +/- 1%(DCV)			

Display of the:

- max. input voltage (1) with respect to earth
- floating voltage (2)
- voltage between channels (3)

according to the installation category, the type or reference of the sensor, and a designation of the main characteristics.

floating
(2)



between channels
(3)



with respect to earth
(1)



1.6.3. Auto scale

Some **Probitx** probes have buttons with programmable settings:

<p>The diagram shows the HX0030 probe with three buttons labeled A, B, and ⊃⊂. A fourth button is labeled RF compensation.</p>	<p>The HX0030 probe has three directly accessible control buttons:</p> <ul style="list-style-type: none"> ▪ Button A (programmable) modifies settings for the connected channel ▪ Button B (programmable) modifies settings for the connected channel ▪ Button ⊃⊂ controls the backlighting of the measurement zone
<p>The screenshot shows a menu titled 'Vertical CH4 - P' with a list of settings: Sensitivity +/-, Vertical position +/-, Timebase +/-, Horizontal position +/-, Trigger edge/run-hold, Auto-meas/ref-meas, and Auto-CHx/auto 50%. A slider control is labeled 'Button a/button.b'.</p>	<p>At the time of connection, all preferred settings stored in the accessories (assignments of buttons A and B + color) are automatically reactivated. They can be modified by pressing the zone shown in the illustration to the left.</p> <p><u>Configuring channels and managing sensors</u></p> <p>The coefficients, scales, and units of the sensors and the configurations of the channels are managed automatically.</p>

1.6.4. Safety message

<p>Accessory identification and safety management</p>	<p>Probes and sensors are automatically recognized when connected. The instrument identifies the probe/sensor and provides information about its characteristics. This helps ensure safety.</p>
--	---

1.6.5. Power supply to the accessories

The oscilloscope supplies power to the **Probitx** accessories.

2. DESCRIPTION

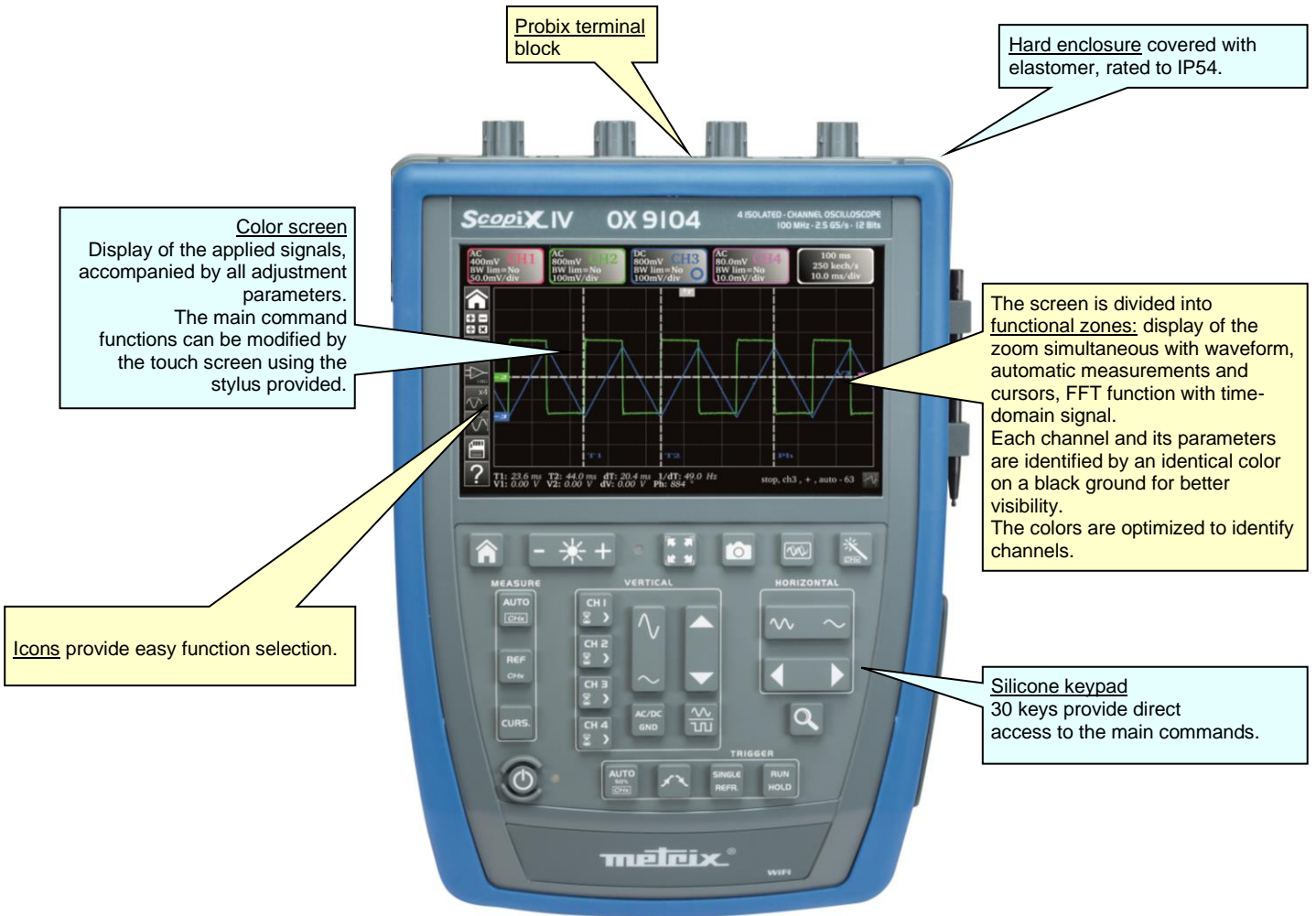

2.1. Front panel



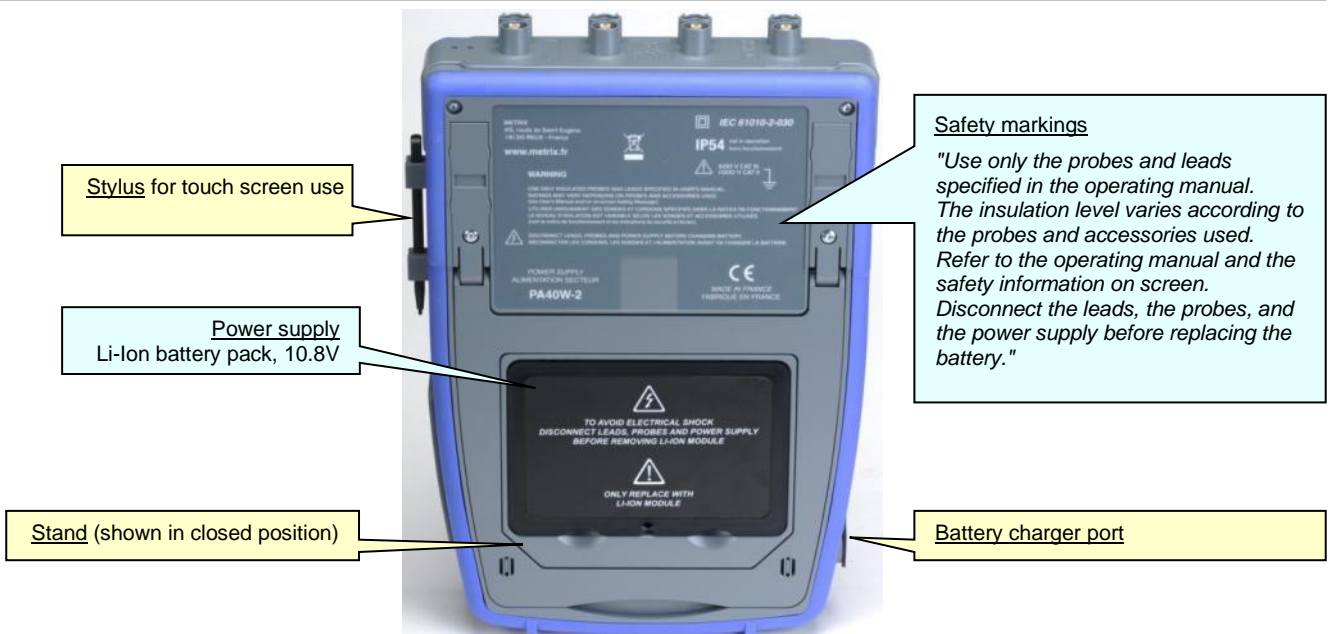

2.2. Rear panel

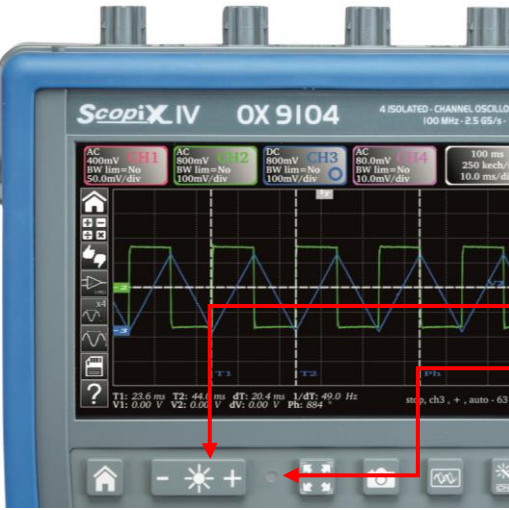



2.3. Touch screen and stylus

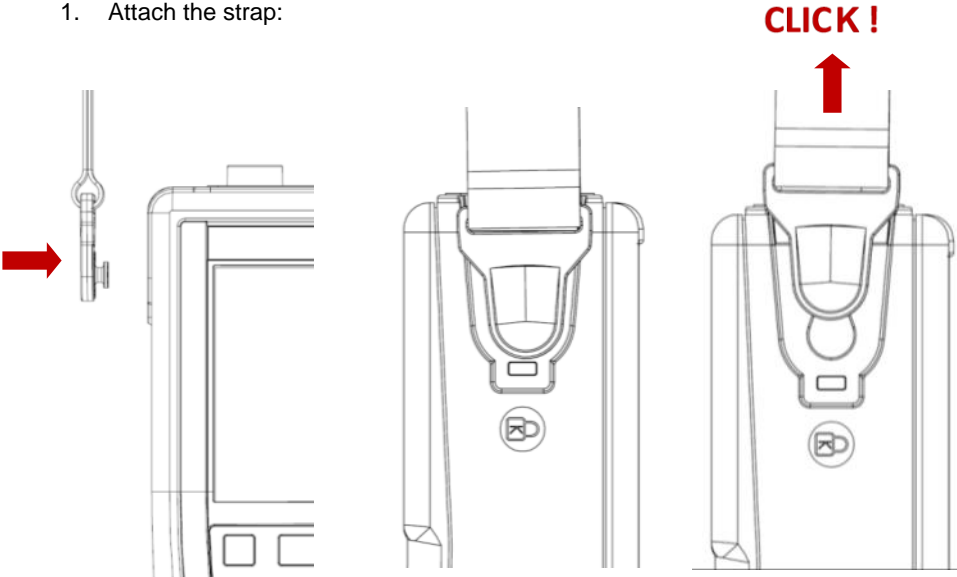
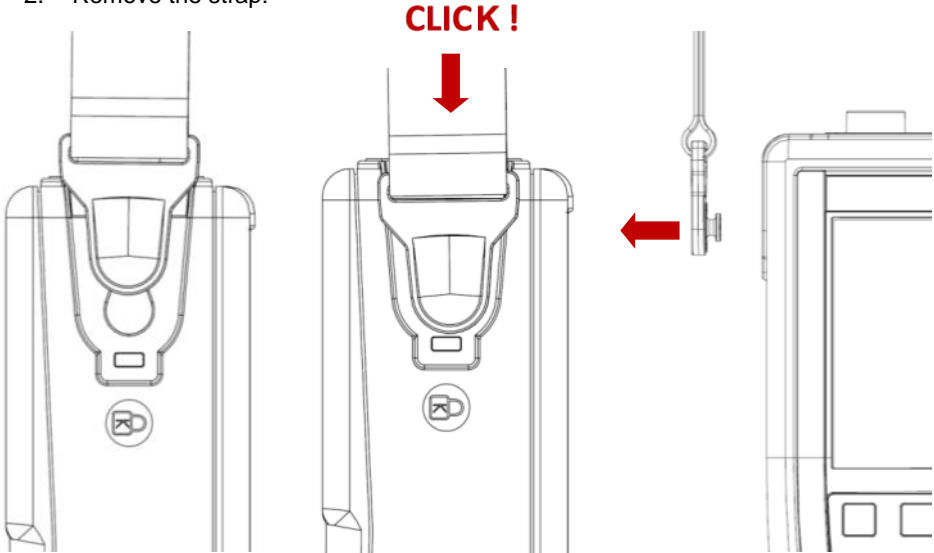



<p>Display</p>	 <p>Color screen:</p> <ul style="list-style-type: none"> ■ LCD WVGA ■ (800x480) ■ 7 inch ■ TFT ■ resistive, color, touch operated (can be used with protective gloves) ■ Backlighting by LEDs ■ <u>Brightness</u> adjustable by the keypad <p><u>Light sensor</u>: automatically adjusts brightness to accommodate ambient light</p> <ul style="list-style-type: none"> ■ The screen: <ul style="list-style-type: none"> - touch-operated - color - water- and dust-resistant - responds to any form of pressure by any pointing resource, such as a stylus or bare or gloved hand ■ Intuitive icons for ease of use. ■ Each channel and its parameters are identified by matching color on a black ground for better legibility. ■ Colors are optimized to facilitate channel identification. ■ Screen is partitioned according to the functions selected: <ul style="list-style-type: none"> - display of the zoom at the same time as the waveform - automatic measurements and cursors - FFT function and time-domain signal
<p>Calibrating the touch screen</p> 	<p>The touch screen can be calibrated from the home window by pressing the  key.</p>

2.4. Accessories

<p>HX0122 strap with removable grip</p>	<p>Attaching the strap (length adjustable from 16.5 to 23.6" [42 to 60cm]) to the instrument:</p> <p>1. Attach the strap:</p> 
	<p>2. Remove the strap:</p> 
<p>Stand providing an angle of 40°</p>	

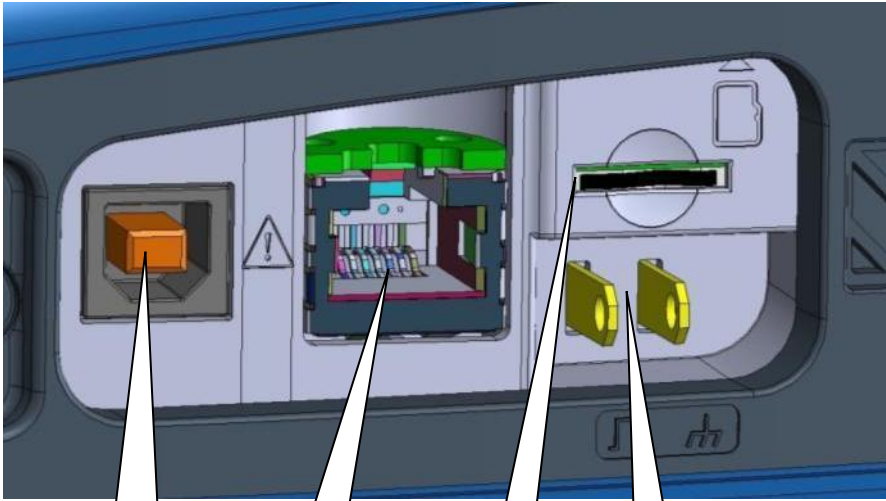

<p>HX0120 carrying case</p>	<p>The carrying/protection case includes:</p> <ul style="list-style-type: none">■ waterproof all-terrain bottom■ 2 handles■ shoulder strap■ removable interior compartment with 3 storage areas:<ul style="list-style-type: none">- 1 central compartment with plasticized pouch for the ScopiX- 2 side pockets with 2 adjustable self-adhesive separators for storing accessories 	
<p>HX0121 stylus</p>		<p>The stylus is stored in the holder on the side of the instrument.</p>
		<p>The stylus has an eyelet. A nylon thread can be passed through it to secure the stylus to the terminal block: 2 holes, with a thread guide between them, are provided for this purpose.</p>

2.5. Communication interfaces

<p>Communication interfaces</p>		<p>Communication ports are grouped in a dedicated compartment on the right side of the oscilloscope and protected by a removable cover.</p>
	 <div style="display: flex; justify-content: space-around; margin-top: 10px;"> <div style="border: 1px solid black; padding: 5px; width: 20%;"> <p>USB connector (USB Type B, 12Mb/s)</p> </div> <div style="border: 1px solid black; padding: 5px; width: 20%;"> <p>RJ45 Ethernet connector (10/100 BASE-T)</p> </div> <div style="border: 1px solid black; padding: 5px; width: 20%;"> <p>μSD card (SD, SDHC, SDXC)</p> </div> <div style="border: 1px solid black; padding: 5px; width: 20%;"> <p>Probe calibration lugs</p> </div> </div>	
	<ul style="list-style-type: none"> ▪ Type B USB (peripheral) for communication with a PC ▪ RJ45 Ethernet wired peripheral ▪ WiFi (default state is inactive) for communication with a PC or with a network printer ▪ High-capacity μSD for data storage <p>The memory icon appears in one of three colors  (refreshed every 5 minutes) to indicate the presence of the SD-Card and the amount space left on the card or the internal memory.</p> <p>The general configuration of the communication interfaces appears when you select the  icon. By default, the WiFi link is inactive.</p>	
<p>Communication type</p>	<ul style="list-style-type: none"> ▪ Hard-wired ETHERNET LAN network (manual/automatic configuration) ▪ WiFi to communicate with a PC or (in an Android environment) with a tablet or smartphone ▪ Type B USB to connect a PC and exchange files or control the instrument 	

3. GETTING STARTED

3.1 General principles

- Dialog boxes are displayed at the bottom of the screen. They do not overlap the graph display area, providing an unobstructed view of the user's action on the channel. (Only adjustments related to the displayed graph remain displayed.) However, in some cases a virtual keypad appears to enable entering alphanumeric content; this keypad appears in the center of the screen and covers the graph display area.
- The  button at top right closes the currently open dialog box.
- Changes to dialog box settings take effect immediately (no confirmation required).
- Selecting  displays the online Help (common to all modes). The Help explains the keys of the keypad: pressing any key of the keypad displays the Help menu of the key pressed, without starting the function associated with the key. The name and icon of the key are displayed above the explanation. To exit Help, point the stylus to the Help window.
- The operating mode is multilingual; screen shots in this manual are in English.

3.2 ON/OFF key



- Pressing this key turns ON the instrument (orange LED lights).
- A short press switches the instrument to standby (orange LED blinks).
- A long press saves the configuration and turns OFF the instrument.

3.3 Screenshot key



Saves screen shots in the **"Screenshot"** folder.

Accessible in the following modes:

- oscilloscope
- multimeter
- logger
- harmonic analyzer

Files are named:
SCOPIX_date_hour-minute-second.png
in the internal memory or on the connected μ SD Card.

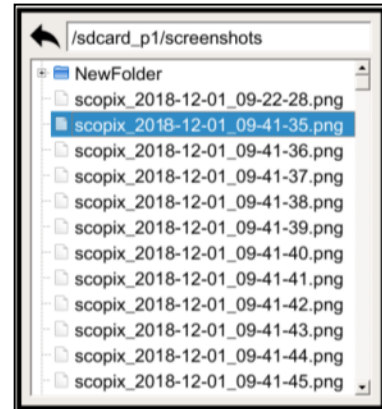

3.4 Full Screen key



Toggles the display mode between normal and "full screen."

The screen is organized to provide optimal area for displaying graphs.





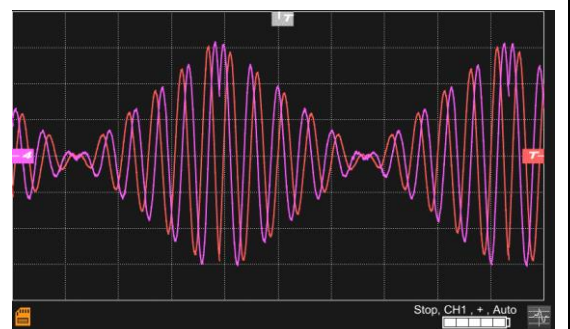

Blanking:

- menu bar
- parameters of the time base traces
- bargraph



from the home screen, this key allows calibration of the touch screen.

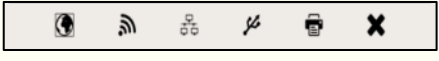

3.5 HOME key and icon

Action ↗	Result ↗	(on the screen) ↗
Press the HOME key on the keypad 	Return to the home screen from a measurement session.	
	Directly access the instrument's operating modes: - oscilloscope → - multimeter → - LOGGER → - harmonic analyzer →	
	Access the internal file management system and the SD-Card (a file contains a saved object).	 → <ul style="list-style-type: none"> ▣ functions ▣ harmonic ▣ logger ▣ NewFolder ▣ screenshots ▣ sdcard_p1 ▣ setups ▣ traces
	Access the system parameters: <ul style="list-style-type: none"> ▪ set time and language ▪ WiFi ▪ network ▪ printing 	 →  <div style="text-align: right;">✓</div>
	Access the following information: <ul style="list-style-type: none"> ▪ serial number of the instrument ▪ hardware version ▪ software version ▪ texts of the licences of the various embedded software modules (GPL, GPL2, LGPL) 	
Click the "HOME" icon on the screen 	Return to the home screen, at any time during your browsing.	

3.6 Brightness key

	Adjusts the brightness of the screen (LED backlighting): <ul style="list-style-type: none"> ▪ min. level → 0% ▪ max. level → 100% You can adjust the brightness according to your exposure: <ul style="list-style-type: none"> ▪ lower → press "-" ▪ higher → press "+" The available steps are 25%, 37%, 50%, 62%, 75%, 87%, 100%. Note: Brightness adjusted automatically until the key is pressed 
---	---

4. OX 9304 FUNCTIONAL DESCRIPTION

4.1 SCOPE mode

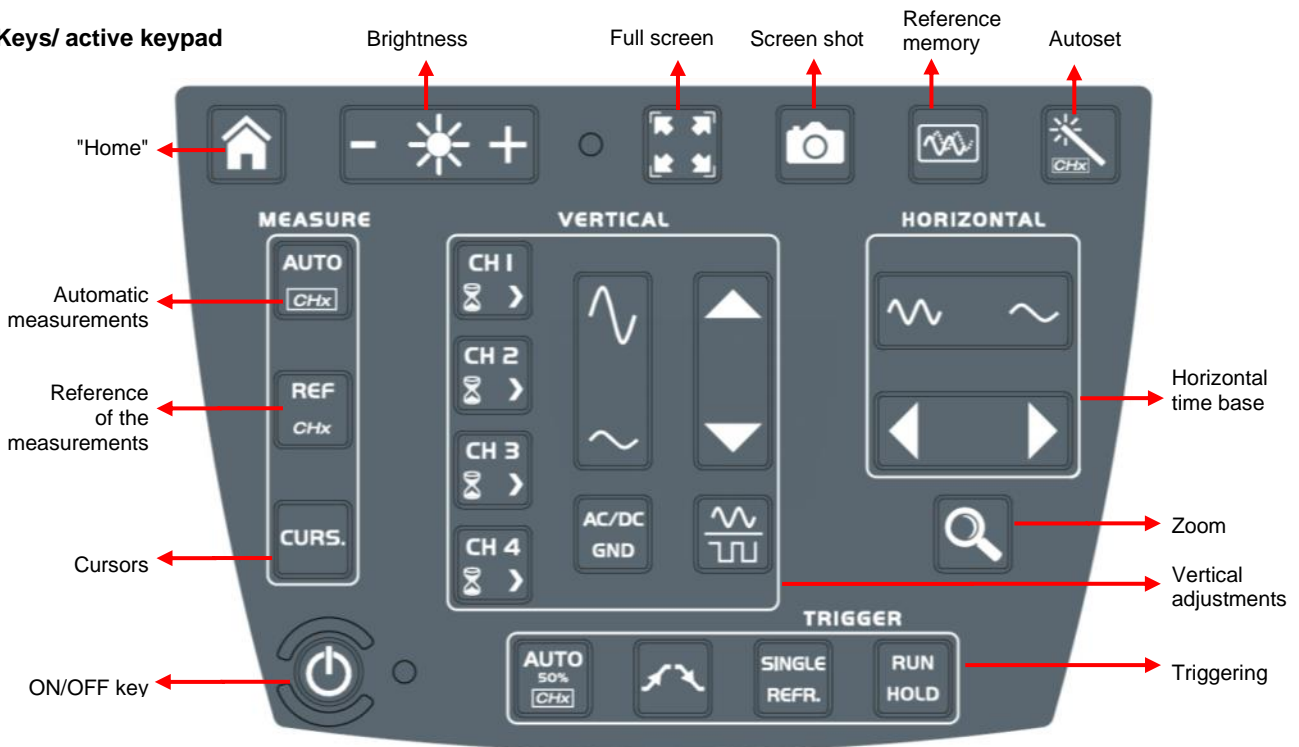

4.1.1 Keys/ active keypad



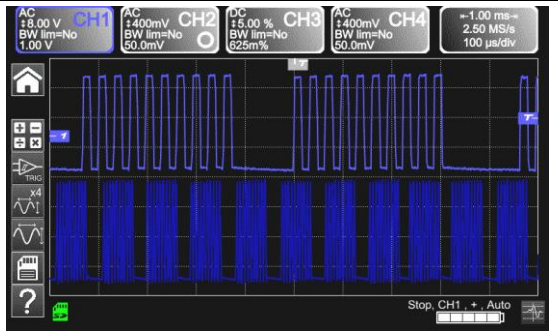



4.1.2 Reference Memory adjustment

 <p>In oscilloscope mode, pressing this key freezes the traces on the screen. The graph is displayed in a darker shade of the channel color as a reference to be compared to a new acquisition. The reference memories are accompanied by their reference numbers. Pressing this key again erases reference memories.</p> <p>This memory is not saved and will be lost when you exit Oscilloscope mode.</p>	
---	--

4.1.3 AUTOSET adjustment → "Magic Wand" key

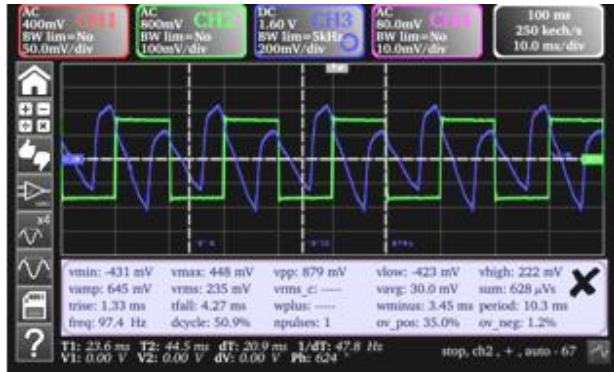

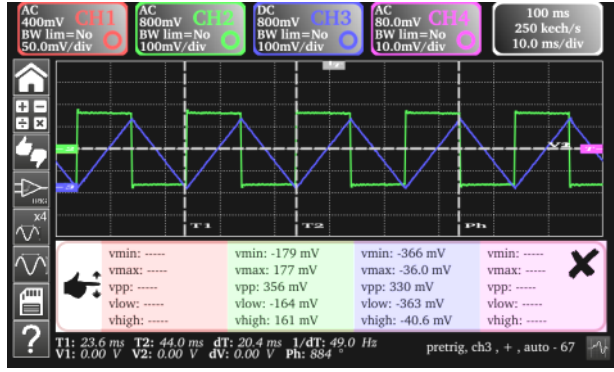
 <p>Automatic optimum adjustment of the AUTOSET of the channels to which a signal is applied. The adjustments are:</p> <ul style="list-style-type: none"> ■ coupling ■ vertical sensitivity ■ time base ■ slope ■ positions ■ triggering <p>The signal having the lowest frequency is used as triggering source. If no trace is detected on the inputs, autoset is aborted.</p> <p>A simultaneous press on  assigns the corresponding channel as triggering source.</p>	
---	--

4.1.4 MEASURE adjustment



	<p>Activates/deactivates window that displays the 20 automatic measurements of the reference trace.</p>	
	<p>Activates the 20 automatic measurements of the 4 traces with displacement by "scrolling".</p> <p>By default, cursors are activated with automatic measurements.</p>	
	<p>Selects, from among displayed traces, the reference trace for automatic and manual measurements. The reference channel is identified by a circle in the color of the channel in the CHx or Fx zone.</p>	
	<p>Activates/deactivates display cursors used for manual measurements.</p> <p>In automatic measurement mode, cursors cannot be deactivated.</p> <p>The vertical and horizontal cursors can be moved on the touch pad via the stylus.</p> <p>The measurements made in position T (period), "dt" (time difference between the two cursors), 1/dt (difference as a frequency, in Hz) and "dv" (voltage difference between the 2 cursors) are reported in the status area. A phase cursor Ph (in °) displays a value for the angle between T and the reference.</p>	

4.1.5 HORIZONTAL time base adjustment

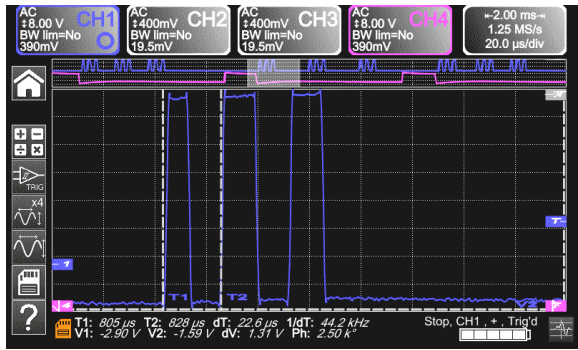
a) from the keypad

	<p>Increases/decreases the coefficient of the time base by successive presses (T/DIV).</p>	
	<p>After a Zoom, the "Z-Pos." adjustment modifies the position of the screen in the acquisition memory (upper part of the screen).</p>	
	<p>Activates/ deactivates the horizontal "Zoom" function</p> <p>A waveform screen is displayed at the top of the screen, with the zoomed portion in the main display area.</p> <p>By default, the zoom is around samples at the center of the screen, but the display area can be moved.</p> <p>A display area can be zoomed by tracing a rectangle around the area to be enlarged using the stylus on the touch pad.</p> <p>The sensitivity values, time base, and horizontal and vertical positions are recalculated automatically.</p>	

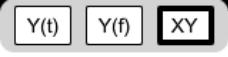
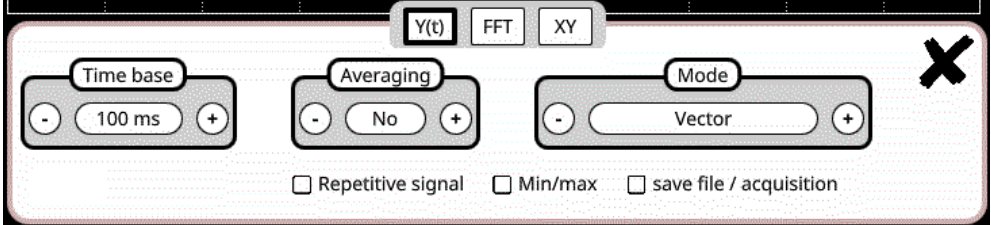
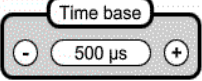
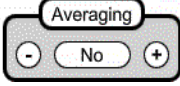
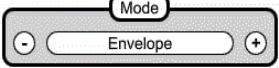
b) from the screen

	Click at top right in the screen, on the Time Base zone (see the image to the left).	
	Description below of the Y(t) - Y(f) - XY display modes	
<p>1. Y(t): time-based view of a waveform</p>		
	Settings from 1ns to 200s	
	<p>No averaging Averaging coeff. 2 Averaging coeff. 4 Averaging coeff. 16 Averaging coeff. 64</p>	<p>Selects a coefficient to calculate an average on the displayed samples (for example to attenuate random noise in a signal). For the averaging coefficient to be taken into account in the representation of the signal, the "Repetitive signal" option must be selected.</p> <p>The calculation is performed using the following formula: Pixel N = Sample*1/Averaging rate + Pixel N-1 (1-1/Averaging rate):</p> <p>Sample Value of the new sample acquired at abscissa t Pixel N Ordinate of the pixel at abscissa t on the screen, at instant N Pixel N-1 Ordinate of the pixel at abscissa t on the screen, at instant N-1</p>
	<p>Vector</p>	A vector is plotted between samples.
	<p>Envelope</p>	The minimum and maximum observed at each horizontal position on the screen are displayed. Use this mode to display a variation in time or of amplitude, or a modulation.
	<p>The entire acquisition</p>	The whole of the acquisition (100,000 samples) is displayed on the screen and a vector is plotted between samples. Use this mode to display all details of the acquisition. This function can be used on a memory or on a graph already acquired.
	<p>Increased time resolution of a trace for a periodic signal. When this option is checked, the signal can be averaged.</p> <ul style="list-style-type: none"> For time bases finer than 100μs/div. (without active zoom mode), the signal displayed is reconstituted from several acquisitions. The time resolution can be as fine as 40ps. If the signal is not repetitive, do not use this option. The time resolution will then be ±1ns. Note that if this choice is checked, signal reconstruction can take an extended time. <p>The following parameters influence this time:</p> <ul style="list-style-type: none"> time base frequency of recurrence of the trigger activity of the Averaging mode <p>During this reconstruction, the signal must be stable (amplitude, frequency, waveform). To speed up the reconstruction following a change in the signal, stop the acquisition, then restart: Stop/Run.</p>	

Functional

<input type="checkbox"/> Min/max	<p>Displays extreme values of the signal, acquired between two samples of the acquisition memory. This mode:</p> <ul style="list-style-type: none"> ▪ detects a false representation due to undersampling ▪ displays short-duration events (Glitch, $\leq 2\text{ns}$). <p>Whatever time base is used, with its corresponding sampling rate, events having a short duration (Glitch, $\leq 2\text{ns}$) are displayed.</p>
	<p>ROLL: Automatic on time base $> 100\text{ms}$, single</p> <p>In single-shot mode, if the time base exceeds 100ms/div, the new samples are displayed as soon as they are acquired. In addition, ROLL mode is activated when acquisition memory is full (scrolling of the trace from right to left on the screen).</p>
<input type="checkbox"/> save file / acquisition	<p>In triggered mode, save/retrieve can be used to record acquisitions in .trc format to the "Traces" directory. This lets you store several rare events in the file system and analyze them later.</p>

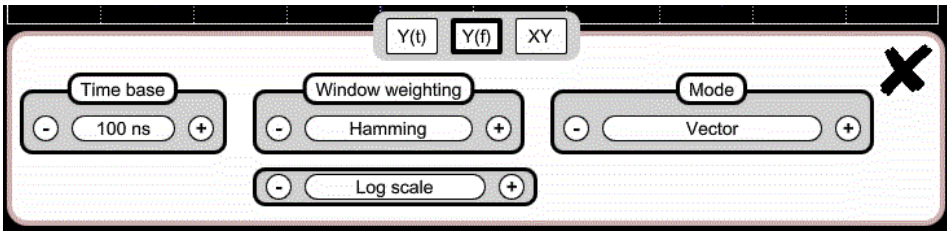

<p>2. $Y(f) = \text{FFT}$ (Fast Fourier Transform)</p>	 <p>The Fast Fourier Transform (FFT) is used to calculate the discrete representation of a signal in the frequency domain from its discrete representation in the time domain. It is calculated on 2500 points. It can be used in the following applications:</p> <ul style="list-style-type: none"> ▪ measure harmonics and distortion of a signal ▪ analyse pulse response ▪ search for a noise source in logical circuits
<p>Fast Fourier Transform calculation</p>	$X(k) = \frac{1}{N} * \sum_{n=-\frac{N}{2}}^{\frac{N}{2}-1} x(n) * \exp\left(-j\frac{2\pi nk}{N}\right) \text{ for } k \in [0 (N - 1)]$ <p> $x(n)$: a sample in the time domain $X(k)$: a sample in the frequency domain N: resolution of the FFT n: time-domain index k: frequency index </p>

Weighting Window

Hamming

- Rectangle
- Hamming
- Hanning
- Blackman
- Flat top

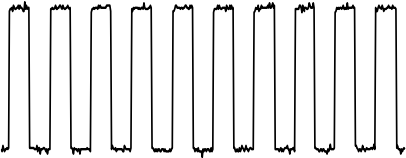

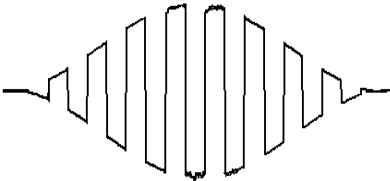
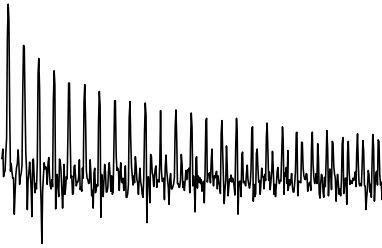
Before calculating the FFT, the oscilloscope weights the signal to be analyzed by a window that acts as a bandpass filter. The choice of window type is essential to distinguish the different spikes of a signal and make accurate measurements.

<i>Time representation of signal to be analyzed</i>	
<i>Weighting window</i>	
<i>Weighted signal</i>	
<i>Frequency representation of the signal calculated by FFT</i>	

The total duration of the study interval results in a convolution in the frequency domain of the signal with a function $\sin x/x$. This convolution modifies the graphic representation of the FFT because of the characteristic lateral lobes of the $\sin x/x$ function (unless the study interval contains an integral number of periods). Five weighting windows are available. The menus appear immediately when you select FFT menu:



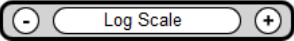
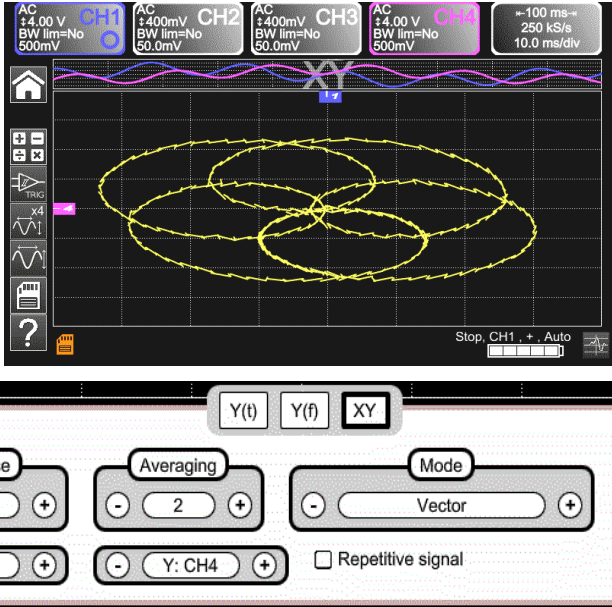

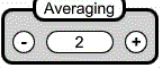
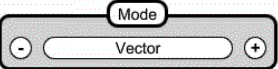
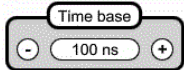
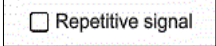
Type of window	Width of the main lobe at 3dB down (bin)	Max. amplitude of the secondary lobe (dB)
rectangular	0.88	-13
Hamming	1.30	-31
Hanning	1.44	-43
Blackman	1.64	-58
Flat top	3.72	-93

Effects of undersampling on the frequency representation:
 If the sampling frequency is too low (less than twice the cutoff frequency of the signal to be measured), the high-frequency components are undersampled and are "aliased" (frequency-shifted) in the graphic representation of the FFT. The Autoset function is active. It avoids the undersampling issue and adapts the horizontal scale to make results easier to view. The Zoom function is active. The zoom affects the graphic representation of the FFT but does not change the conditions of acquisition (TB + depth).

	<p>Horizontal unit: This is displayed in place of the time base and is calculated from the sweep coefficient:</p> $\text{Unit in } \left(\frac{\text{Hz}}{\text{div}}\right) = \frac{12.5}{\text{Sweep coefficient}}$ <p>Vertical unit: The sub-menus provide two possibilities:</p> <p>a) Linear scale: by selecting the FFT menu, then linear scale in (V/div) = $\frac{\text{unit of the signal in its time-domain representation (V/div)}}{2}$</p> <p>b) Log scale: by selecting the FFT menu, then log (logarithmic) scale dB/div. = by assigning 0dB to a signal of 1 RMS amplitude division in the time representation</p> <p><i>The vertical position indicator of the representation is at -40dB.</i></p>
<p>3. XY</p>	
 	<p>Assign signals to the horizontal (X) and vertical (Y) axes. Selected via "+/-". Each axis is graduated in 8 divisions.</p>
	<p>No, 2, 4, 16, 64</p>
	<p>Vector, Envelope, Entire acquisition</p>
	<p>Settings from 1ns to 200s</p>
	<p>Increases the time resolution of a trace for a periodic signal</p>



4.1.6 Adjustment of the amplitude of the "VERTICAL" signal

a) from the keypad

	<ul style="list-style-type: none"> ▪ Select channel ▪ Activate channel ▪ De-activate channel
	<p>Adjust the vertical sensitivity of the last channel selected:</p> <ul style="list-style-type: none"> ▪ Increase the vertical sensitivity ▪ Decrease the vertical sensitivity <p>The sensitivity is displayed in the parameter display area of the channel. It takes into account the parameters of the "Vertical scale" menu.</p>
	<p>Adjusts position of the selected graph on the screen:</p> <ul style="list-style-type: none"> ▪ Move up ▪ Move down
	<p>Select, by successive presses on the input coupling, "AC", "DC" or "GND" of the last channel selected</p> <p><u>Modification of the coupling AC - DC - GND:</u></p> <ul style="list-style-type: none"> ▪ AC → blocks the DC component of the input signal, attenuates signals below 10Hz. ▪ DC → transmits the DC and AC components of the input signal. ▪ GND → the instrument internally connects the input of the selected channel to a reference level of 0V.
	<p>Activates or deactivates the horizontal division by 4 of the display zone.</p> <p>Activation of the "Full Trace" function is indicated by:</p> <ul style="list-style-type: none"> ▪ continuous horizontal line between the display zones ▪ horizontal division of the graticule by 2 <p>After this function is activated, traces can be moved vertically in their zones.</p>



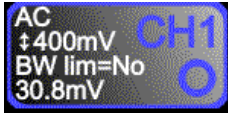
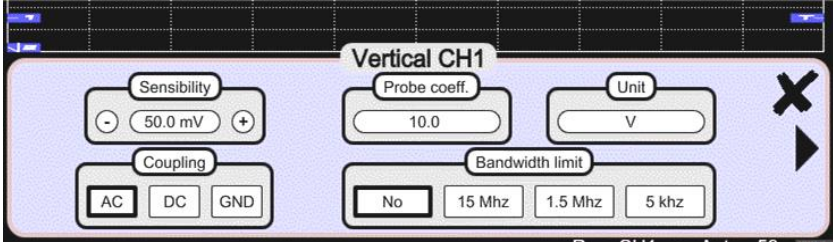
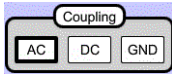

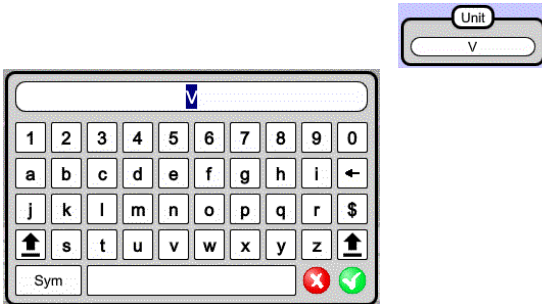
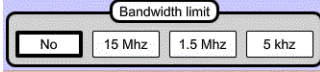
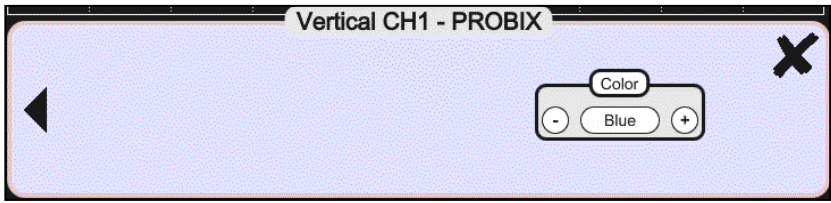

b) from the screen









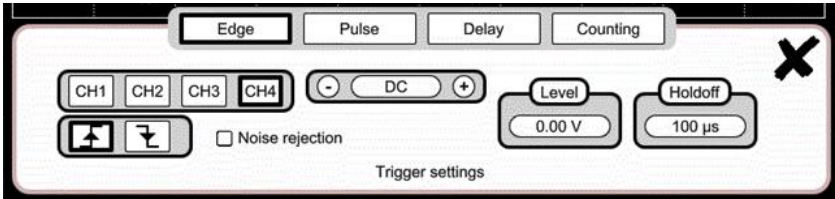
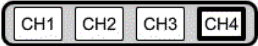

 <p>Example:</p>	<p>Defines the vertical scale of the selected channel. This produces a reading of the direct measurements of the quantity analyzed and of its unit.</p>
	
	<p>Coupling: AC → AC DC → DC GND → GND</p>
	<p>Coefficient: Assigns a multiplier coefficient to the sensitivity of the selected channel. Select this via the stylus, on the digital keypad of the "Coefficient" zone, and validate by pressing .</p> <p>The sensitivity displayed in the selected channel's parameters will be modified as a function of this coefficient.</p>
	<p>Unit of measurement: Defines vertical scale unit of the selected channel. Select the "measurement unit" zone and enter the name using the stylus in the table of available characters (not more than 3).</p> <p>The vertical scale unit appears in the modified channel's parameters display.</p>
	<p>Bandwidth limit, 3 filters can be selected: 15MHz, 1.5MHz and 5kHz <i><u>BX limit is adjusted only from the adjustment menu of the channel, by clicking it with the stylus</u></i></p> <p>Limits bandwidth of the channel and of its triggering circuit, to moderate display noise and spurious triggerings. The bandwidth of each channel can be limited to 5kHz, 1.5MHz, or 15MHz.</p> <p>The bandwidth limit of a channel appears in the command zone by the parameter BW limit.</p>
<p><i>Selection of the color:</i></p> <ul style="list-style-type: none"> - <u>red</u> - <u>green</u> - <u>magenta</u> - <u>blue</u> 	

4.1.7. Adjustment of the triggering level "TRIGGER"

a) from the keypad

	<p>Adjusts the triggering level on the mean value of the signal (50%) without modifying the coupling of the trigger. Pressing this button combined with a CHx key starts the same function, but first selects the corresponding channel as triggering source.</p>
	<p>Sets the triggering slope (positive or negative). The slope is displayed in the status zone.</p>
	<p>Cycles through acquisition mode options:</p> <ul style="list-style-type: none"> ▪ Single-shot = SINGLE (sgl)" on the screen ▪ Triggered (trig'd) ▪ Automatic (Auto) = REFRESH
	<ul style="list-style-type: none"> ▪ SINGLE-SHOT mode: A single acquisition triggered by the trigger by pressing the RUN HOLD key is allowed. For another acquisition, the triggering circuit must be reset by pressing the RUN HOLD key. The ROLL mode is automatically activated. ▪ TRIGGERED mode: Updates the screen only when a triggering event linked to the signals present on the inputs of the oscilloscope (CH1, CH2, CH3, CH4) occurs. In the absence of any triggering event linked to the signals present on the inputs (or in the absence of signals on the inputs), the trace is not updated. ▪ AUTOMATIC mode: Updates the screen even if the triggering level is not detected in the signals on the inputs. In the presence of a triggering event, the refreshing of the screen is managed as in the "Triggered" mode. ▪ Acquisitions in TRIGGERED and AUTOMATIC modes are enabled or stopped. ▪ The triggering circuit in SINGLE-SHOT mode is reset. ▪ Acquisition is started according to the conditions defined by the acquisition mode (SINGLE REFR). ▪ The status of the acquisition is indicated in the status zone: <ul style="list-style-type: none"> - RUNNING → started - STOP → stopped - PRETRIG → acquisition

b) from the screen

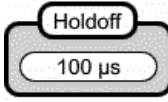
<p>1. Edge</p> 	
	<p>Selects a channel as triggering source: <i>E.g. CH4 → Triggering source</i></p>
	<p>Selects the filter of the main triggering source:</p> <p>AC AC coupling (10Hz to 300MHz): blocks the DC component of the signal.</p> <p>DC DC coupling (0 to 300MHz): passes the whole signal.</p> <p>LF Reject Rejection of source signal frequencies < 10kHz: facilitates the observation of signals having a DC component or an undesirable low frequency.</p> <p>HF Reject Rejection of source signal frequencies > 10kHz: facilitates the observation of signals containing high-frequency noise.</p> <p>The symbol indicating the triggering level on the graph also indicates the coupling:</p> <p> DC</p> <p> AC</p> <p> LF Reject</p> <p> HF Reject</p>
	<p>Selection of the triggering slope:</p> <ul style="list-style-type: none"> positive-going triggering slope Rise edge +  negative-going triggering slope Fall edge -  <p>The selected triggering slope is displayed in the status zone.</p>
	<p>0.00V Adjusts triggering level</p> <p>The triggering level displayed in the current value display zone. It can then be finely adjusted.</p>
<input type="checkbox"/> Noise rejection	<p>No Hysteresis ≈ 0.5 div.</p> <p>Yes Hysteresis ≈ 1.5 div.</p>
	<p>100 μs:</p> <ul style="list-style-type: none"> disables triggering for a preset duration stabilizes triggering on pulse trains <p>Pointing to this field opens on screen a virtual digital keypad for direct entry of the value.</p>

2. Pulse

Pulse

Selects the width of the “triggering on pulse” value:

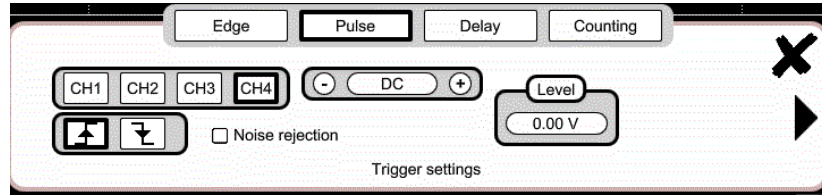

The edge is selected either in the "Trigger" tab or from the keypad and defines the limits of the analysis:

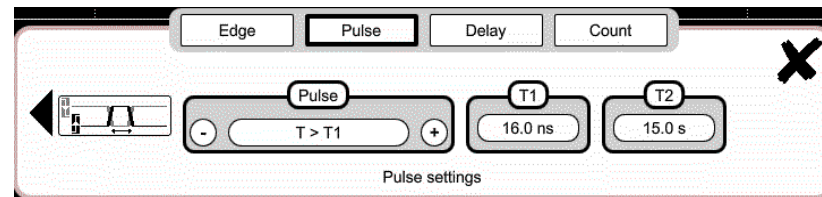
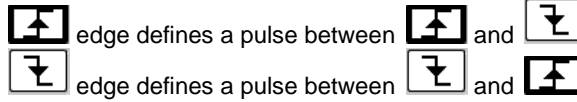

In all cases, the actual triggering is on the end-of-pulse edge:

$t > T1$	triggers on a pulse if its duration is greater than setpoint T1
$t < T1$	triggers on a pulse if its duration is less than setpoint T1
$t > T1$ and $t < T2$	triggers on a pulse if its duration is between T1 and T2
$t < T1$ or $t > T2$	triggers on a pulse if its duration is outside the limits defined by T1 and T2

3. Delay

Delay

Qualifier

Adjusts the qualification source:

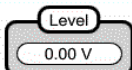
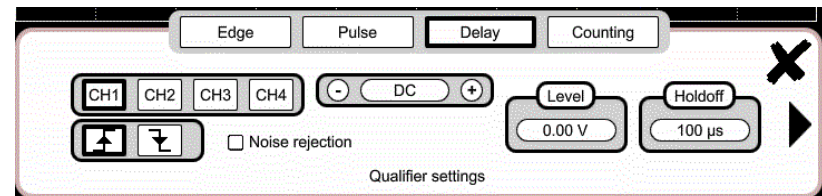



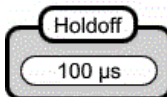



0.00V Triggering level

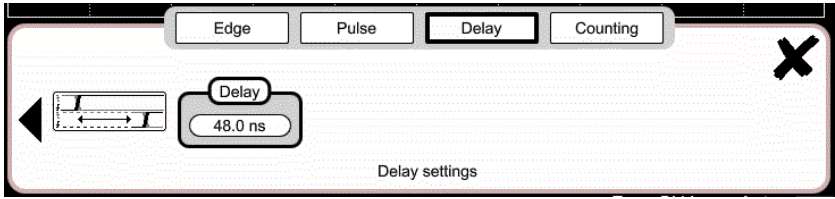

100 μs Adjustment: disables triggering for a preset duration and (among other things) stabilizes triggering on pulse trains.

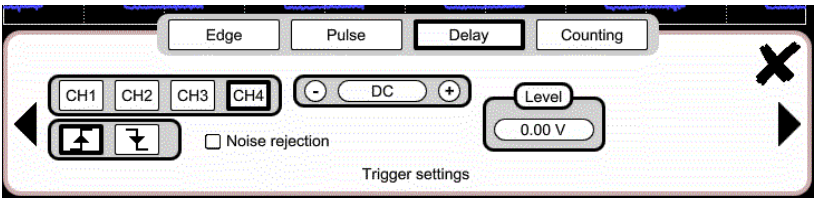
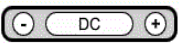
Pointing to this field opens a virtual **digital keypad** for direct entry of the value.





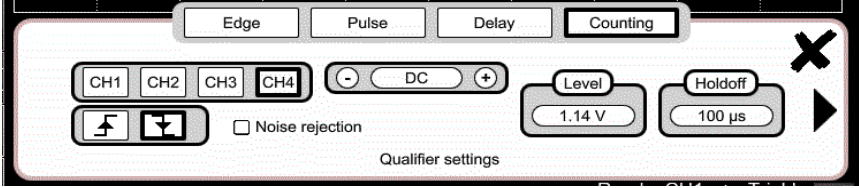
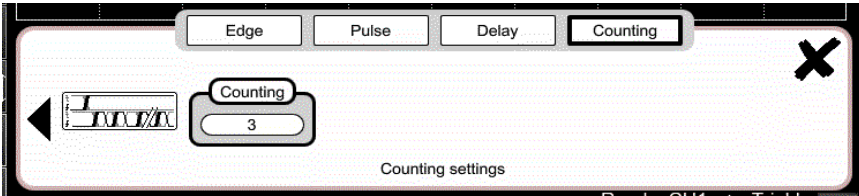
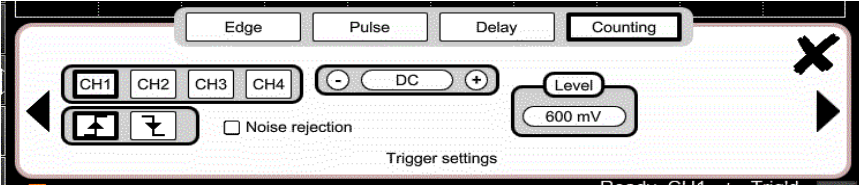

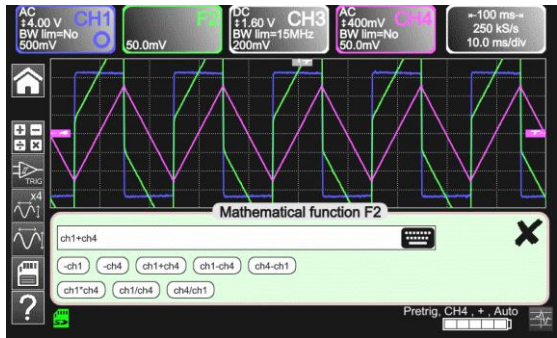
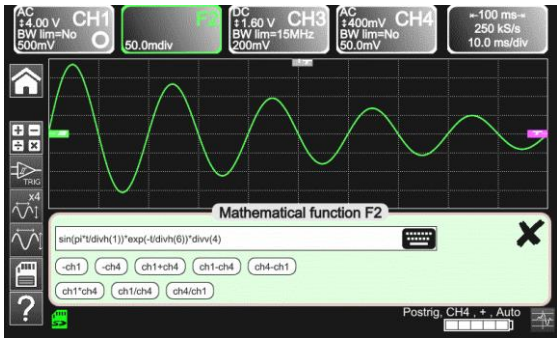
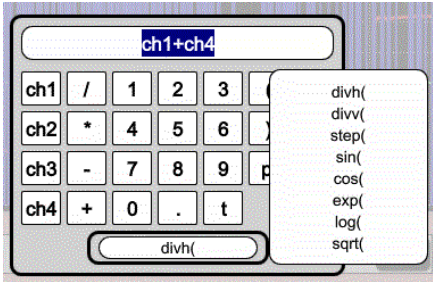

<p><u>Triggering delay</u></p>	<p>Selects delay:</p>  <p>Pointing to this field opens a virtual digital keypad for direct entry of the value.</p> 
<p><u>Trigger Adjustments on the triggering source</u></p>	<p>Selection of triggering on edges with delay:</p>  <p>The delay is triggered by the auxiliary source. Actual triggering occurs on the next event in the main source after the end of the delay.</p>
   <input type="checkbox"/> Noise rejection	<p>Selects filter of the auxiliary triggering source:</p> <p>AC AC coupling (10Hz to 300MHz): blocks the DC component of the signal.</p> <p>DC DC coupling (0 to 300MHz): passes the whole signal.</p> <p>LF Reject Rejection of source signal frequencies < 10kHz: facilitates the observation of signals having a DC component or an undesirable low frequency.</p> <p>HF Reject Rejection of source signal frequencies >10kHz: facilitates the observation of signals containing high-frequency noise.</p> <p>Positive-going triggering slope of the auxiliary source </p> <p>Negative-going triggering slope of the auxiliary source </p> <p>No Hysteresis \approx 0.5 div. Yes Hysteresis \approx 1.5 div.</p>



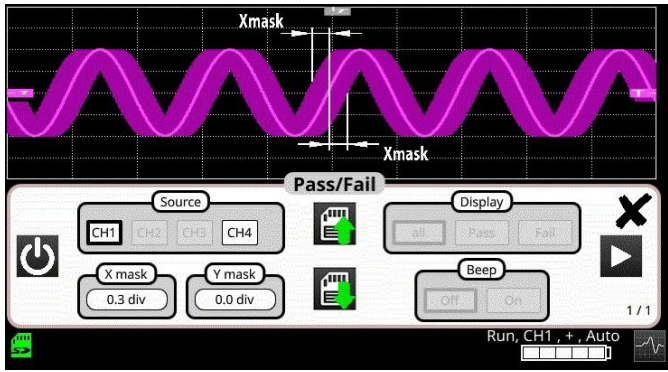

<p>4.Counting Counting</p> <p><u>Qualifier</u></p> <p>Holdoff 100 μs</p>	<p>Selects triggering on edge with counting of events.</p> <p>Selects adjustments on the qualification source:</p>  <p>100 μs Disables triggering for a preset duration and (among other things) stabilizes triggering on pulse trains.</p> <p>Pointing to this field opens a virtual digital keypad for entering the value.</p>
<p><u>Counting settings</u></p> <p>Counting 3</p>	<p>The counting is triggered by the auxiliary source; the main source serves as counting clock. Actual triggering occurs on the next trigger event in the main source after the end of the count:</p>  <p>3 Selects number of events.</p> <p>Pointing to this field opens a virtual digital keypad for entering the value.</p>
<p><u>Trigger</u></p> <p>DC</p> <p>Level 600 mV</p> <p><input type="checkbox"/> Noise rejection</p> <p>Positive Negative</p>	<p>Selects adjustments on the triggering source:</p>  <p>Selects filter of the auxiliary triggering source:</p> <p>AC AC coupling (10Hz to 300MHz): blocks the DC component of the signal.</p> <p>DC DC coupling (0 to 300MHz): passes the whole signal.</p> <p>LF Reject Rejection of source signal frequencies < 10kHz: facilitates observation of signals having a DC component or an undesirable low frequency.</p> <p>HF Reject Rejection of source signal frequencies >10kHz: facilitates the observation of signals containing high-frequency noise.</p> <p>Positive positive-going triggering slope</p> <p>Negative negative-going triggering slope</p> <p>The triggering slope selected is indicated in the status zone.</p> <p>600mV Triggering level</p> <p>No Hysteresis \approx 0.5 div.</p> <p>Yes Hysteresis \approx 1.5 div.</p>

4.1.8. MATHEMATICAL function, from the screen

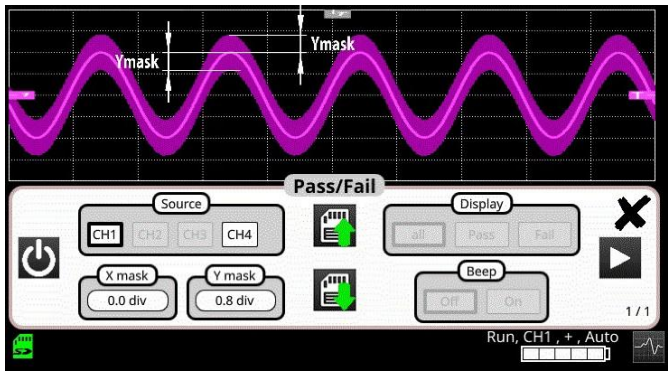

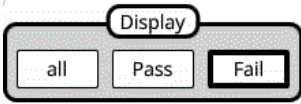
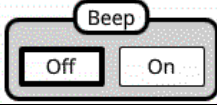

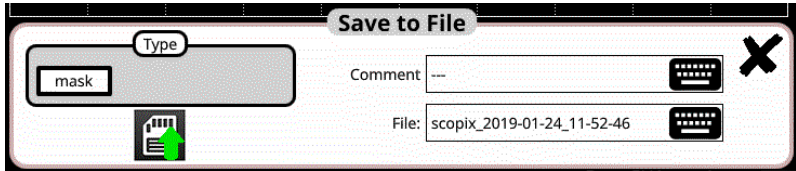
	<p>Defines, for each trace, a mathematical function and vertical scale</p> <p>Equation editor (functions, in the channels or simulated, programmable as F1, F2, F3, F4):</p> <ul style="list-style-type: none"> ▪ Addition ▪ Subtraction ▪ Multiplication ▪ Division ▪ Complex functions between channels 	
<p>Simple functions</p>	<p><i>Example:</i> Addition between channels</p>	
<p>Complex functions</p>	<p><i>Example:</i> Production of a damped sinusoidal trace from predefined functions</p>	<p>$math1 = \sin(\pi * t / \text{divh}(1)) * \exp(-t / \text{divv}(6)) * \text{divv}(4)$</p>  <p>"sin(pi*t/divh(1))" changes the number of periods. "exp(-t/divv(6))" changes the damping level.</p>
<p>Defining a complex function</p>		<p>8 predefined mathematical functions can be used:</p> <ul style="list-style-type: none"> ▪ divh() → "horizontal division" ▪ divv() → "vertical division" ▪ step() → "on" using "t" (*) ▪ sin() → "sine" ▪ cos() → "Cosine" ▪ exp() → "exponential" ▪ log() → "logarithmic" ▪ sqrt() → "square root" <p>(*) t = abscissa of the sample in the acquisition memory <i>divh(1)</i> is equivalent to 10,000 samples (points) = 1 horizontal div.</p>

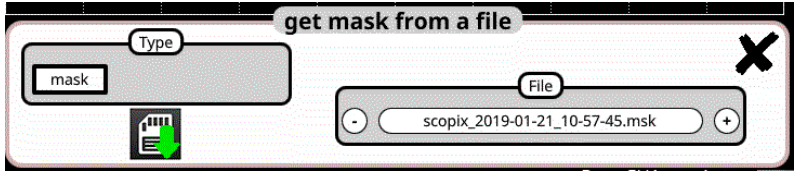
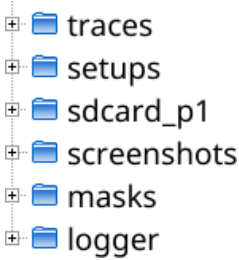
4.1.9. PASS/FAIL function from the screen

	<p>Opens the « Pass/Fail » menu</p> <p>The Pass/Fail function is used to compare the evolution of the real-time signal to a mask. If the real-time signal satisfies the predefined mask, the signal Passes; otherwise, the signal Fails.</p>
	<p>Activates/deactivates the Pass/Fail mode</p>
	<p>Starts the analysis.</p> <p>12 / 86 Acquisition counter</p>
	<p>Selects the source for application of the mask and analysis.</p>
	<p>Defines the width of the mask.</p>  <p>When a value is entered, the message "mask calculation in progress" appears, then the new mask is displayed</p>
	<p>Defines the height of the mask.</p>  <p>When a value is entered, the message "mask calculation in progress" appears, then the new mask is displayed</p>

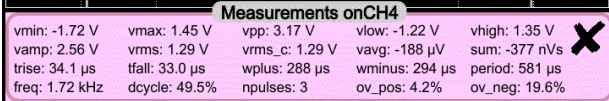
	<p>All: Displays the number of acquisitions in real time</p> <p>Pass: Displays the number of acquisitions that satisfy the conditions of the predefined mask.</p> <p>Fail: Displays the number of acquisitions that fail to satisfy the conditions of the predefined mask.</p>
	<p>Activates the audible beep</p>
	<p>Pressing this key displays the following screen:</p>  <p>Use this function to record the configuration of the mask in local memory or on a μSDCard</p>
	<p>Pressing this key displays the following screen:</p>  <p>Use this function to restore a mask configuration from the local memory or the μSDCard</p>
<p>Note :</p> 	<p>The .msk file is stored in the "masks" directory in local memory or on the μSDCard.</p>

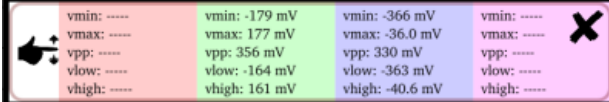
4.1.10 AUTOMATIC measurements, from the screen

	<p>Opens the "Automatic measurements" Menu window of the channel</p>	
	<p>Opens the "Automatic measurements" Menu window of the 4 channels</p>	
<ul style="list-style-type: none"> Measurements are made and refreshed on the selected reference trace. All measurements that can be made on this trace are displayed. (- . - -) is displayed for measurements that cannot be made. To close the window, point to  with the stylus. All 20 measurements selected will be displayed in the status zone at the bottom of the screen, on a background the color of the channel: 		

vmin	minimum peak voltage	trise	rise time
vmax	maximum peak voltage	tfall	fall time
vpp	peak-to-peak voltage	wplus	positive pulse width (at 50% of Vamp)
vlow	stabilized low voltage	wlow	negative pulse width (at 50% of Vamp)
vhigh	stabilized high voltage	period	period
vamp	amplitude	freq	frequency
vrms	RMS voltage determined in the measurement interval	dcycle	duty cycle
vrms_c	RMS voltage determined on a whole number of cycles	npulses	number of pulses
vavg	mean voltage	over_pos	positive overshoot
sum	summation of the instantaneous values of the signal	over_neg	negative overshoot

 Measurement conditions	<ul style="list-style-type: none"> The measurements are made on the part of the trace displayed on screen between cursors T1 and T2. Any modification of the signal entails an update of the measurements. They are refreshed as the acquisition proceeds. The accuracy of the measurements is optimum when at least two complete periods of the signal are displayed.
---	---

Automatic measurements

- Positive overshoot = $[100 * (V_{max} - V_{high})]/V_{amp}$
- Negative overshoot = $[100 * (V_{min} - V_{low})]/V_{amp}$
- $$V_{rms} = \left[\frac{1}{n} \sum_{i=0}^{i=n} (y_i - y_{GND})^2 \right]^{1/2}$$
- $$V_{avg} = \frac{1}{n} \sum_{i=0}^{i=n} (y_i - y_{GND})$$
- $$V_{sum} = \sum_{i=0}^{i=n} (y_i \times \delta t)$$
- YGND = value of the point representing zero volts

4.1.11. Backup

Pressing this key displays the screen shown below:

Use this function to record (in local memory or on an μ SD Card) the following:

- traces displayed
- mathematical functions
- configuration of the instrument



These files can be restored from the file manager.

4.2 Multimeter mode

4.2.1 Keys/keyboard active in Multimeter mode



The **ScopiX** has a Multimeter function with 8000 display points. It has as many independent multimeters as there are channels in the Oscilloscope mode (2 or 4), with the same function as in the Oscilloscope mode: **ProbiX**.







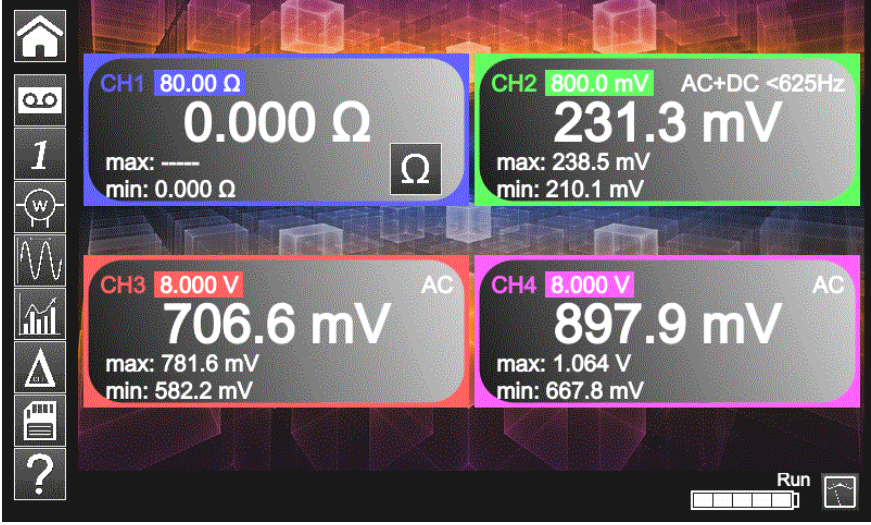

	<p>Coupling:</p> <p>If a channel is activated and selected, pressing this key changes the input coupling of the channel. With successive presses, the coupling runs through the following settings: AC → AC <5kHz → AC <625 → AC+DC → AC+DC <5kHz → AC+DC <625Hz → DC.</p> <p>Adjusting the coupling is not possible in the following modes: Ohmmeter, Capacitance meter, Continuity, Test of component, Wattmeter.</p> <p><u>Modification of the coupling (AC, DC, AC + DC) in amplitude measurement</u></p> <ul style="list-style-type: none"> ▪ AC: AC voltage measurement ▪ DC: DC voltage measurement ▪ AC + DC: AC voltage measurement with a DC component <p>If the channel measures AC or AC + DC voltage, you can filter the signal with a low-pass analog filter having a cutoff frequency of 5kHz. The other filter proposed is a digital filter at 625Hz; if this filter is chosen, the 5kHz analog filter is also activated.</p> <ul style="list-style-type: none"> ▪ Low-pass filter ▪ Cutoff frequency 625Hz ▪ Order..... 94 ▪ Bandwidth ripple..... 0.5dB ▪ Transition band 0.02 ▪ Stopband attenuation 50.0dB
	<p>Manual measurement range. De-activates Autorange and returns to manual mode. The Autorange function is active by default; pressing this key changes to manual range.</p>



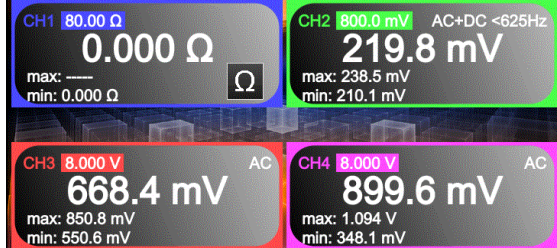

4.2.2 Icon/screen of the Multimeter mode

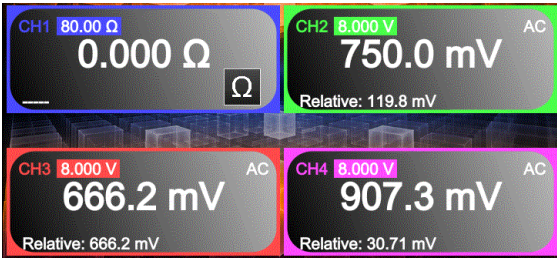
The channel is displayed in the color defined in Oscilloscope mode. Inactive channels are displayed in white.







<p>Display screen: 4 measurements 4 channels</p>	
<p>1 Channel 1</p> 	<p>Several types of measurement are possible on CH1; the other channels are voltmeter channels only. A display zone is reserved for each channel. Each displays the following information:</p> <ul style="list-style-type: none"> ▪ CH1, CH2, CH3, or CH4 as Voltmeter 2 ▪ Ohmmeter and audible safety beep ▪ Continuity ▪ Capacitance meter ▪ Test of component <p>Volt: no display of the symbol (lower part of the CH zone)</p> <p> The display of the measurement automatically takes into account the characteristics of Probix (in particular for temperature measurements by PT100/TK).</p>
<p>Autorange</p>	<p>A long press on channel CH validates or invalidates autorange of the channel. If Autorange is active, the range is displayed in white in a colored square.</p>
<p>Main measurement</p>	<p>If the channel is activated, the measurement result is displayed. Otherwise the message "- X -" occupies the unused space. If "-----" is displayed, measurement is not possible: it is outside the authorized range, and "OL" is displayed.</p>
<p>Unit</p>	<p>Contains the measurement unit associated with the current measurement range according to the Probix used and the type of measurement. The unit cannot be configured in multimeter mode.</p>

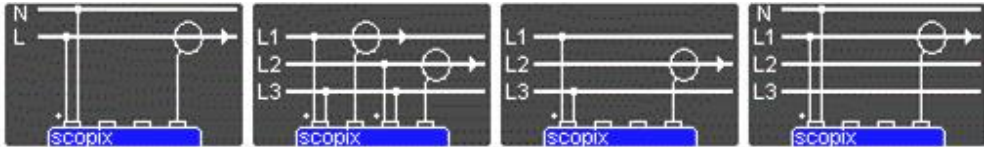

<p>Secondary measurements</p>	<p> If no display is selected, or if no display is possible (e.g. frequency measurement of a DC signal, etc.), the string '-----' is displayed.</p> <p>If the channel is not selected, the string '-X-' is displayed. If the signal is outside of the range: "OL" for overload is displayed.</p>	
<p>Frequency</p> 	<p>For an AC amplitude measurement, displays frequency of the measured signal (if possible and coherent) in each channel.</p>	
<p>Statistics</p> 	<p>Displays Min and Max values of measurements for each channel.</p>	
<p>Relative mode</p> 	<p>Displays difference in each channel.</p> <p>This is the difference between the measured value and the value displayed when this key was pressed.</p>	

4.2.3 Adjustments of the VERTICAL menu

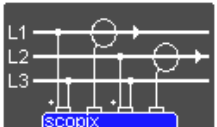
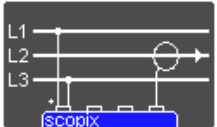
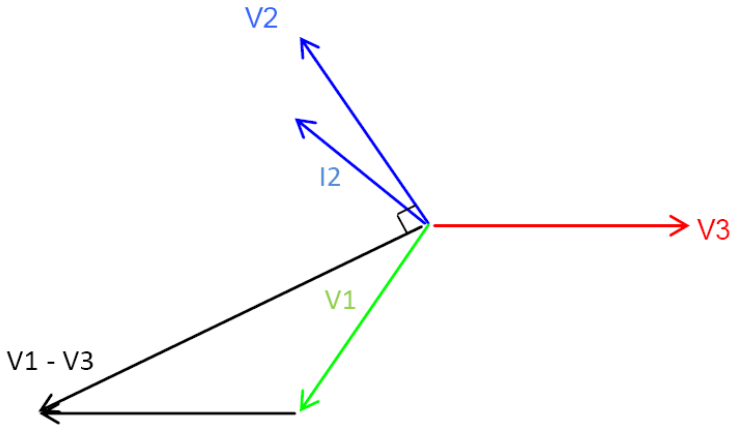
	<ul style="list-style-type: none"> ▪ Activates/de-activates parameters of channels CH1, CH2, CH3, CH4 independently of one another ▪ Parameter types determined by the connected Probix (adjustment in oscilloscope mode) ▪ Quantity displayed depends on: <ul style="list-style-type: none"> - type of measurement selected: <ul style="list-style-type: none"> · amplitude (available on all channels) · ohmmeter · continuity · capacitance meter - Probix PT100/TK temperature probe (available on all channels) - Probix probe connected to the input - parameters defined in the vertical parameter zone (if they have been modified since the connection of the Probix probe) <p> For the ranges available according to the type of measurement, refer to the technical specifications, "Multimeter" function.</p>
	<p>Changes manual range.</p>
	<ul style="list-style-type: none"> ▪ RUN → Start of measurements ▪ HOLD → Freeze of the measurement

4.2.4 Power measurement

<p>Display</p> 		<p>The following secondary measurements are available in this quantity:</p> <ul style="list-style-type: none"> ■ MIN/MAX ■ relative ■ frequency
<p>Selecting distribution network type and power parameters</p>		
	<p><u>Single-phase</u></p> $P_A = \frac{1}{N} * \sum_N V(n) * I(n)$	
	<p><u>Three-phase without neutral (two-wattmeter method)</u> Available only for 4 channel instruments</p> $P_A = \frac{1}{N} * \sum_N (U_{12}(n) * I_1n + U_{32}(n) * I_3(n))$ $P_R = \frac{\sqrt{3}}{N} * \sum_N (U_{12}(n) * I_1n - U_{32}(n) * I_3(n))$	
	<p><u>Balanced three-phase without neutral (3 wires)</u></p>  <p>Voltage V3-V1 measurement and measurement of the current on I2</p> $P_A = \sqrt{3 * (\hat{U} * \hat{I})^2 - P_R}$ $P_R = \frac{\sqrt{3}}{N} * \sum_N (U_{13}(n) * I_2(n))$	
	<p><u>Balanced three-phase with neutral</u></p> $P_A = \frac{3}{N} * \sum_N V(n) * I(n)$	

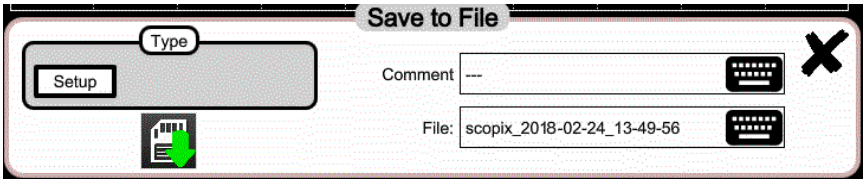
	<p>Clicking either icon exits Power mode.</p>
	<p>Configuration backup.</p> 

4.3. **LOGGER mode** 

4.3.1 Keys/keyboard active in **LOGGER mode**



When you enable **LOGGER** mode, a file is automatically generated. This file records up to 10,000 measurements in all active channels: duration of the record 20,000s, resolution 0.2s.



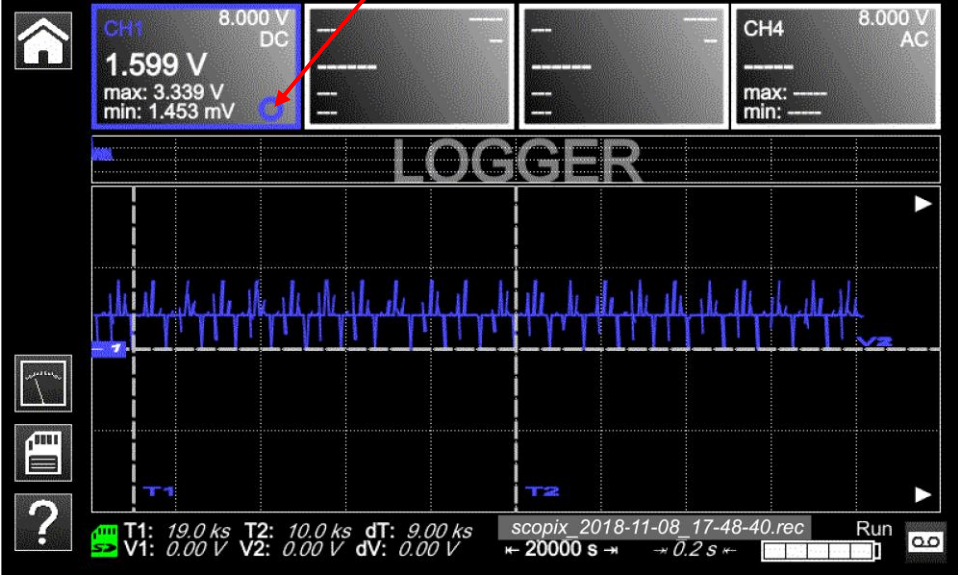

4.3.2 Icons/screen in LOGGER mode

	<p>LOGGER mode records measurements made in multimeter mode.</p> <p>Displays graphic time window, showing the time course of the measurements. The most recent measurements are on the right.</p> <p>The measurement cursors can be used.</p> <p>This <u>indicator</u> displays the reference channel:</p>
	

The time of the measurements is the right-hand edge of the screen (indicated by the two white triangles).

The file name blinks to indicate that recording is in progress.

4.3.3 Principles







<p>Automatic sequential recording</p>	<p>(N files of 100,000 measurements) in the memory of the LOGGER directory.</p> <p>Leave enough space for the recording.</p>
	<p>In the event of a power outage, the oscilloscope remains battery powered to keep files being recorded in memory.</p>
	<p>Click these icons twice to exit LOGGER mode.</p>
	<p>Opens Help file.</p>
	<p>Saves configuring settings in a file.</p> 



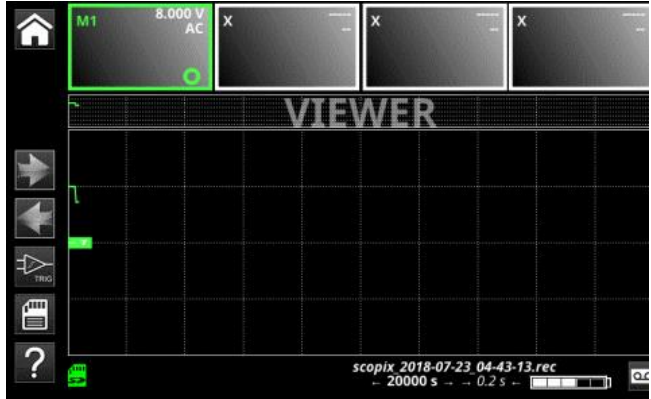
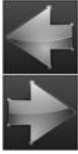

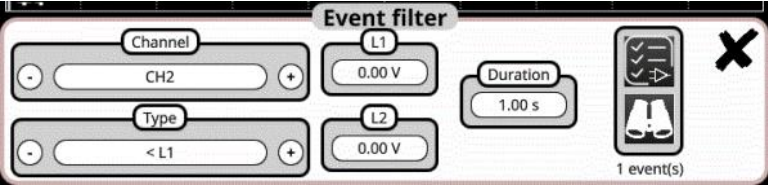

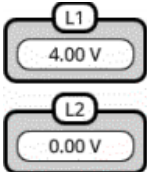
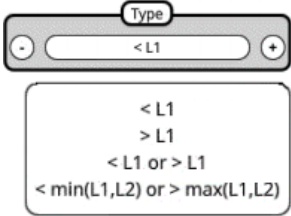
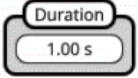

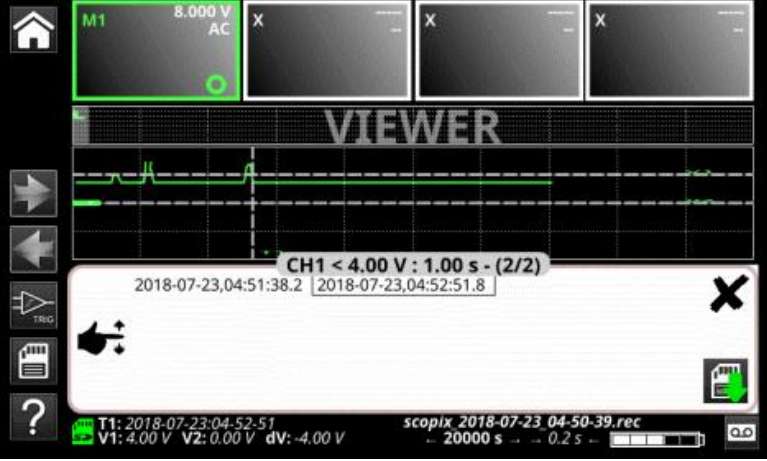

Note: In this mode and in VIEWER mode, it is possible to display cursors.

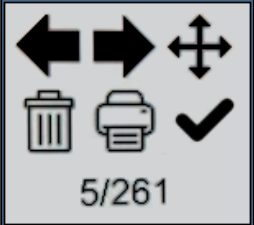
4.4. VIEWER mode



<p>File manager</p>		
<p><i>Look-up files in internal memory and μSD Card</i></p>		
	<p>Creates a new directory.</p>	
	<p>Erases a directory or a file after confirmation.</p>	
	<p>Duplicates a file.</p>	
	<p>Renames a file from the alphanumeric keypad.</p>	
	<p>Displays an analysis file, which opens in the mode recorded (except for .png screenshot files, which are opened in a specific viewer with file processing tools: erasure, printing, displacement of windows).</p>	
	<p>Converts .rec and .trc files into .txt files to allow use in an Excel type spreadsheet. After conversion, the file appears in the tree, renamed and recorded with the same name as the original file:</p>	
		<p> Example on left: .rec file converted to .txt. file</p> <p> ScopiX cannot read the.txt file.</p> <p> Conversion to .txt can take some time. Wait for the end-of-conversion symbol .</p>
	<p>Exit Viewer mode.</p>	
<p>Typical directories (chronological order)</p>	<ul style="list-style-type: none"> ▪ traces: .trcf files of the Oscilloscope mode ▪ setups: configuration files stored in Multimeter, Logger, Harmonic ▪ sdcard_p1: content of the μSD Card (partition 1) ▪ screenshots: .png screen shot of each mode ▪ logger-events: .txt files saved after a search for events ▪ logger: .rec TRACE or .cfg configuration files acquired in LOGGER mode to be displayed, printed, exported, etc. <p>You can select several files simultaneously (for deletion or copy).</p>	

VIEWER	
<p>Recalling a .rec file</p>	<p>"VIEWER" file appears in the screen background and the LOGGER mode is identified by the icon at bottom right of the screen:</p> 
	<p>Arrows for browsing from one file to another in the same directory.</p>
<p>Search for events</p>	<p>It is possible to search for events in VIEWER mode. An event is defined by a threshold and the direction in which it is crossed.</p>
	<p>Selects event search parameters.</p> 
	<p>Selects channel in to search for events.</p>
	<p>Selects thresholds L1 and L2.</p>
	<p>Selection of search criterion:</p> <ul style="list-style-type: none"> ▪ < L1: Search for an event less than threshold L1 ▪ L1: Search for an event greater than threshold L1 ▪ < L1 or >L1: Search for an event less than L1 or greater than L1 ▪ <min(L1,L2) or >max(L1,L2): Search for an event less than the smaller of the couple (L1;L2) or for an event greater than the larger of the couple (L1;L2)
	<p>Minimum duration of the event.</p>
	<p>Start the search for events.</p>

	<p>Analyze events found. Pressing this icon opens a window containing the events meeting the search criteria.</p>  <p>When an event is selected, the V1, V2, and T1 cursors appear. The associated measurements are displayed below the event window. The event name format is YYYY-MM-DD,HH :MM :SS .s where YYYY-MM-DD is the date of the record and HH :MM :SS.s is the value of the T1 cursor.</p>
	<p>Records the events in .txt format. These events are recorded in the logger-events folder in File Manager.</p>
<p>Recalling a .png file</p>	 <p>A window (which can be moved by cursor) appears at the top of the screen:</p> <ul style="list-style-type: none">   → moves from one file to another  → moves the window on screen  → erases the file, after confirmation  → prints the file on the network printer pre-programmed in "Tools"  → closes the .png viewer window  → Number of files in the directory

4.5. HARMONIC mode

4.5.1. Keys/keyboard active in Harmonic mode

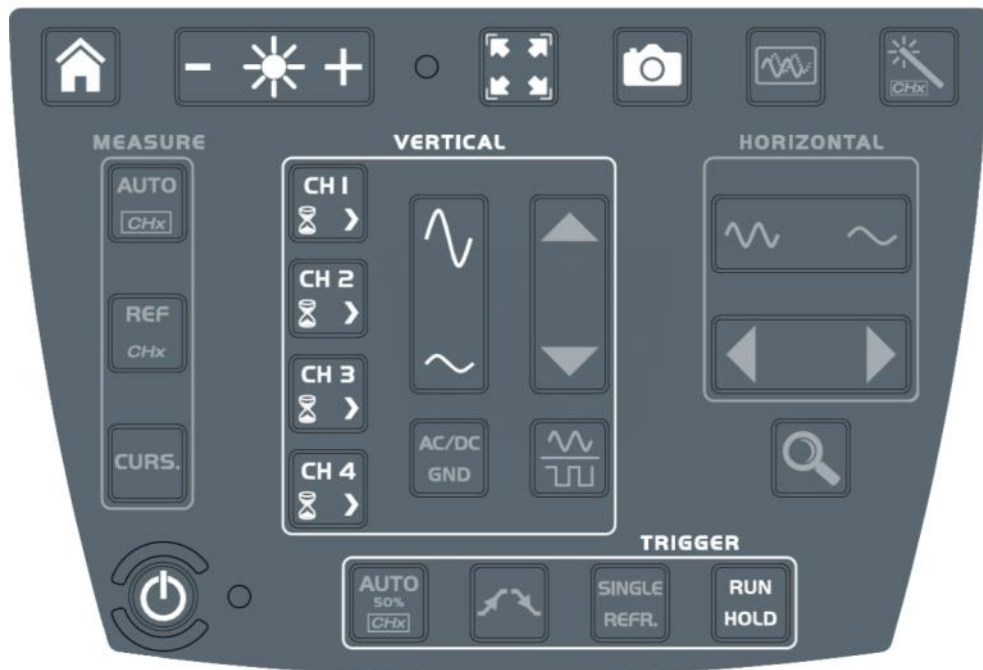

4.5.2. Principle

<i>Harmonic mode</i>	<p>Displays the breakdown into harmonics of a voltage or a current of which the signal is steady-state or quasi-steady-state. It establishes a first diagnostic of the harmonic pollution of an installation.</p> <p>This mode displays a graph of the fundamental frequency and harmonics out to the 63rd.</p> <p>The time base is adaptive; it is not adjusted manually.</p> <p>This analysis is only for signals with a fundamental frequency between 40Hz and 450Hz.</p> <p>Only channels CHx (not the functions or the memories) can undergo a harmonic analysis.</p> <p>The harmonic analysis of 2 (OX 2 channels) or 4 (OX 4 channels) signals can be displayed simultaneously.</p>
-----------------------------	--

4.5.3. Icons/screen in Harmonic mode

Displays harmonic analysis of the selected traces.

The harmonic analyses of traces **ch1** and **ch4** appear as solid-color bar charts, in the color of the trace.

By default, the fundamental is selected automatically; but the fundamental frequencies of 50Hz/60Hz and 400Hz can be programmed manually.

Auto
Hz

Auto
Hz

50
Hz

60
Hz

400
Hz

SIGNAL		HARMONIC 63			
Vrms = 144.8 mV	THD = 920.3 %	Ratio = 14.4 %	Phase = 161 °	Freq = 9.84 kHz	1.805 mV
Vrms = ---	THD = ---	Ratio = ---	Phase = ---	Freq = ---	---
Vrms = 8.433 A	THD = 1.9 %	Ratio = 0.1 %	Phase = 50 °	Freq = 3.15 kHz	5.203 mA
Vrms = ---	THD = ---	Ratio = ---	Phase = ---	Freq = ---	---

The measurement parameters displayed:

Signal Measurement

- RMS voltage of the signal in V
- total harmonic distortion (THD) in %, per standard EN50160

$$THD = \frac{1}{V_{RMS}(Fund)} \times \sqrt{\sum_{Harm=2}^{40} V_{RMS}^2(Harm)}$$

Harmonic Measurement

- value in %, ratio
- phase in ° with respect to the fundamental
- frequency in Hz
- RMS voltage in V

SIGNAL		HARMONIC 1			
Vrms = 234.1 V	THD = 1.8 %	Ratio = 100.0 %	Phase = -0 °	Freq = 50.0 Hz	234.1 V
Vrms = ---	THD = ---	Ratio = ---	Phase = ---	Freq = ---	---
Vrms = 8.443 A	THD = 1.8 %	Ratio = 100.0 %	Phase = 0 °	Freq = 50.0 Hz	8.441 A
Vrms = ---	THD = ---	Ratio = ---	Phase = ---	Freq = ---	---

Example: Harmonic of order 1, incrementing of display of the harmonic order by + and decrementing by -



Power harmonics

Choice of set-up with type of power.





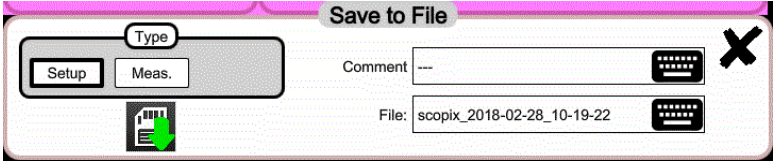

Solid bars indicate harmonics consumed and hollow bars harmonics generated.

SIGNAL		HARMONIC 1			
Vrms = 324.7 mV	THD = 48 %	Ratio = 6.2 %	Phase = 0 °	Freq = 39.1 Hz	1.178 mV
Vrms = ---	THD = ---	Ratio = ---	Phase = ---	Freq = ---	---
Vrms = 8.388 A	THD = 35.7 %	Ratio = 100.0 %	Phase = -0 °	Freq = 39.1 Hz	643.0 mA
Vrms = ---	THD = ---	Ratio = ---	Phase = ---	Freq = ---	---







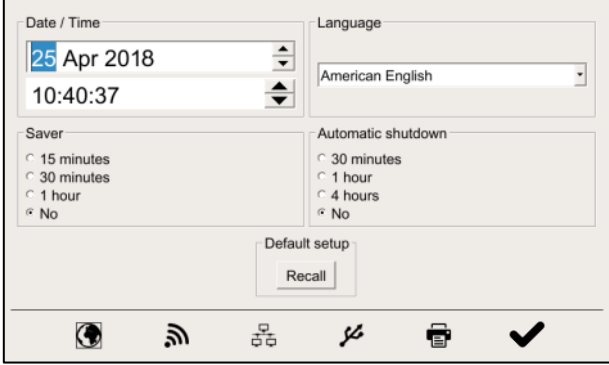

46

	Exits Harmonic mode.
	Opens Help file.
	

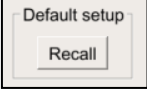
4.6. Communication

	<p>The communication interfaces are grouped in a dedicated compartment on the side of the Scopix, protected by a removable cover.</p> <p>You can communicate on several interfaces:</p> <ul style="list-style-type: none"> ▪ USB type B for communication with a PC The cord supplied connects to the USB type A port of a PC: transfer of file, programming using SCPI commands ▪ Ethernet via RJ45 cords or via WiFi for communication with a PC or printing to a network printer or, in an Android environment, communication with a tablet or smartphone ▪ High-capacity µSD Card for storing data or loading configurations, available capacity depending on the type of card ▪ internal disc: 512MB data storage capacity available 	
	<ul style="list-style-type: none"> ▪ By default, files are recorded in internal memory. 	 green: memory under 50% full
	<ul style="list-style-type: none"> ▪ Files are recorded in the µSD Card, if it is installed. 	 orange: memory 50 to 80% full  red: memory over 80% full





4.6.1 General parameters

<p>Configuration </p>		
 Date/Time	<p>Updates date (day, month, year) and time (hour, minute, second). The selection is made by the stylus, using the scroll bars on either side of the parameters to be adjusted. The clock starts when the menu is closed.</p>	
Language	<p>Selects language used in the menus. Options include French, English, German, Italian, Spanish, and others (contact AEMC for the latest additional options).</p>	
Screen saver	<p>The screen saver is activated after a specified time, to save power and extend the life of the screen. There are 4 options: 15min, 30min, 1h, no saver mode. The screen is reactivated by pressing any key on the front panel.</p>	
Auto off	<p>The instrument turns OFF after a specified time to save power. In this case, instrument configuration is saved before power OFF. There are 4 options: 30min, 1h, 4h, no auto off.</p>	
 Default setup	<p>Default setup restores the factory configuration parameters. When the instrument is turned ON it uses the settings in place the last time it was turned OFF. Recall results in the instrument starting up using the default (factory) configuration.</p>	
Keys		<p>WiFi configuration. You can:</p> <ul style="list-style-type: none"> ■ scan the network at any time, then select the additional page of settings as soon as the network has been chosen. ■ modify the fields IP address, subnetwork mask, gateway, then validate by "Connect". The network is then stored and WiFi communication is active.
	<p>Ethernet configuration, including Automatic (DHCP) or manual setting of IP parameters (Address, Subnet Mask and Gateway). Assigns a link-local address in case of DHCP failure (point-to-point link).</p>	
	<p>USB configuration, including manual setting of IP parameters (Address, Subnet Mask and Gateway). Programming: cf. installation guide, RNDIS driver for Windows 7</p>	
	<p>Network printer configuration, including the IP address of the printer and/or its name if there are several printers in the network (contact your network administrator to ensure the presence of this type of server). An alphanumeric keypad appears.</p>	
	<p>Exit the setup menu.</p>	

<p>IP address</p>	<p>An IP address is coded in 4 bytes, displayed in decimal form. (📶: 132.147.250.10).</p> <p>Each field can be set between 0 and 255; the fields are separated by decimal points. Unlike the physical address, the IP address can be modified manually by the user or automatically by DHCP.</p> <p>Ensure the IP address is unique on your network. A duplicate address could impact network operation.</p>
<p>Subnetwork mask and Gateway</p>	<p>If the result of the "LOGICAL AND" between the IP address of the addressee of the message and the value of the subnetwork mask (SUBNET MASK) is different from the address of the addressee of the message, the message is sent to the gateway (GATEWAY), which takes charge of getting it to its destination.</p> <p>The mask and the address of the gateway can be configured on the instrument.</p>
<p>DHC protocol</p>	<p>This protocol automatically sets network access.</p> <p>A DHCP (Dynamic Host Configuration Protocol) server must be accessible in this network (contact your network administrator to ensure this is the case).</p>
<p>MAC address</p>	<p>Each ScopiX instrument has a unique factory-configured MAC address. There is one wire network MAC address and one WiFi address.</p>
<p>WiFi network selection</p>	<div data-bbox="512 725 975 1279" data-label="Image"> </div> <p>To connect to the WiFi network:</p> <ol style="list-style-type: none"> 1. Press Scan to manually scan the available networks (this is done automatically when the WiFi menu is opened). 2. Select the SSID network. 3. Enter the network's security key. 4. Select DHCP mode if you want the network to give you an IP address, or manual mode if you already have a fixed IP address. 5. Click Connect to confirm the settings and complete connection.
<p>Wire network selection</p>	<div data-bbox="512 1301 975 1574" data-label="Image"> </div> <ol style="list-style-type: none"> 1. Select DHCP mode if you want the network to give you an IP address, or manual mode if you already have a fixed IP address. 2. Click Connect to confirm the settings and complete connection.
	<div data-bbox="512 1597 975 1868" data-label="Image"> </div> <p>"About" - (cf. p.17)</p>

4.7. Memory



Backup memory	The files are stored in a specific partition. File system: 1. on an μ SD Card; the partitions of the μ SD Card are accessible in the sdcard_pX directory 2. in the local file system		
Available memory	<ul style="list-style-type: none"> ▪ Internal memory of the instrument: 1GB for the file system ▪ "Micro SD" memory card, type: SC (≤ 2GB) HC (> 2Go ≤ 32Go) XC (> 32Go ≤ 2To) <p>of which the partition(s) are formatted to FAT32.</p>		
Memory space optimization and consumption	▪ Files of traces acquired in SCOPE mode	.trc	Size: 400kB per trace stored (max.: 1.6MB)
	▪ Files of traces acquired in LOGGER mode, Binary format	.rec	Size: 400kB per trace stored (max.: 1.6MB)
	▪ Configuration files, Binary format	.cfg	Size: 1ko
	▪ Printing	.png	Size: <200ko
	▪ Files of mathematical functions, Text format	.fct	Size: <1ko
	▪ Files in text format containing a trace acquired in HARMONIC mode	.txt	Size: <10ko
	▪ Text format files resulting from the conversion of binary files (.rec or .trc)	.txt	Size : variable

Storage options by mode					
	Icon 	Icon 	Icon 	Icon 	Keypad 
Type of file	Setup.(cfg)	Traces.(trc)	Math.(fct)	Measurement.(txt)	Screen shot.(png)
Oscilloscope mode	✓	✓	✓		✓
Multimeter mode	✓				✓
Harmonic mode	✓			✓	✓
Logger mode	✓				✓
Viewer mode				✓	✓
Directory	setups	traces	functions	harmonic	screenshots

Note: all files in "SCOPIX" including NF are viewable on a PC as an external disk via the USB port.

Ethernet communication is reserved for remote control of the instrument. The SCOPENET application, running on a PC, uses the files in memory in SCOPIX.

4.8. Firmware update

<p>Firmware</p>	<p>Periodically, an "update available" message may appear on the home screen, if the ScopiX is connected to Ethernet or WiFi:</p>  <p>This message indicates update files have been downloaded transparently to the ScopiX: they are available for an update, which is recommended to obtain new functions, bug fixes; etc.</p> <ul style="list-style-type: none"> ▪ Select OK and the update automatically installs the files in the ScopiX. ▪ The duration of the update varies, but is less than 15 minutes. ▪ Follow the directions (see below). ▪ Do not switch off ScopiX during the update. ▪ The files of the internal memory (measurements, screen shots, setups, etc.) are not destroyed during the update. ▪ For more complete information, go to the support space of our Web site: a manual update procedure is available.
<p>Update installation procedure</p>	<ol style="list-style-type: none"> 1. Connect the ScopiX, preferably to line power. 2. Check "Do you want to install it." 3. ScopiX powers OFF, then back ON. 4. A screen (yellow-white) of which the color varies to represent an action in progress, with an "update running" message, remains on screen for approximately 8 minutes. 5. ScopiX powers OFF and then back ON. 6. A touch slab calibration procedure screen is displayed: follow the steps by checking the 4 corners, then the center. 7. The home screen is displayed again: you can view the new system information (date, version, etc.); the update is complete. <p> <i>The operating instructions in .pdf format, or any other updated document, can be downloaded and placed in the file manager.</i></p>

4.9. ScopeNet IV



When you have obtained the IP address of the **Scopix** (DHCP or manual) using a browser, type 14.3.250.51/scopenet.html (for example) on your computer; the screen to the left appears.

*JAVA application PC is used to display the **ScopeNet IV** page.*

Carefully check the installation of **ScopeNet** to minimize issues.

To check the instruments connected, do the following:

- Press the network icon, in the center of the screen: the search for instruments in the network (Ethernet and WiFi) is performed by a specific function. A series of compatible instruments connected is displayed (see illustration on left).
- The PC environment uses icons in an HMI identical to the **Scopix IV** product, with the same access to the functions and adjustments.

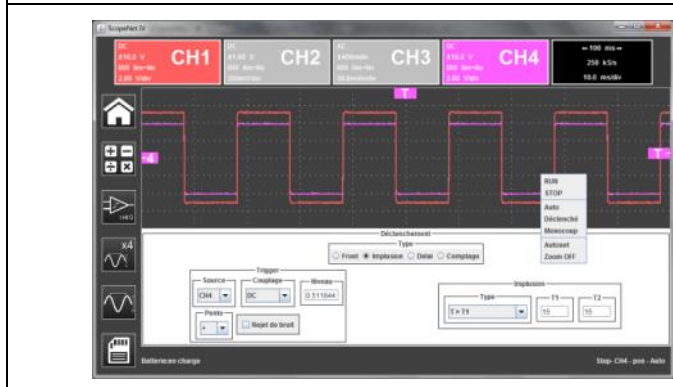
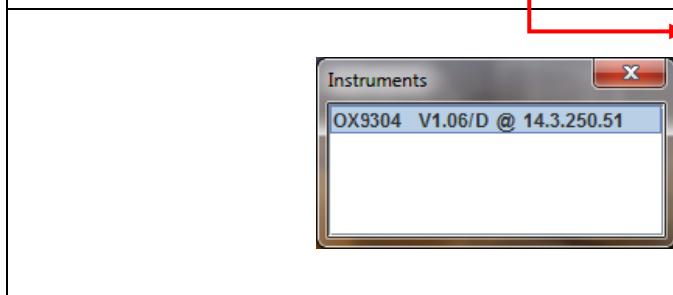

In Oscilloscope mode, **ScopeNet IV** proposes adjustments by a right click on the waveform: RUN/STOP, AUTO/TRIG/SINGLE/AUTOSET and ZOOM are easy-to-configure parameters.

*Example: 2 active channels: CH1 and CH4
2 greyed-out inactive channels: CH2 and CH3*

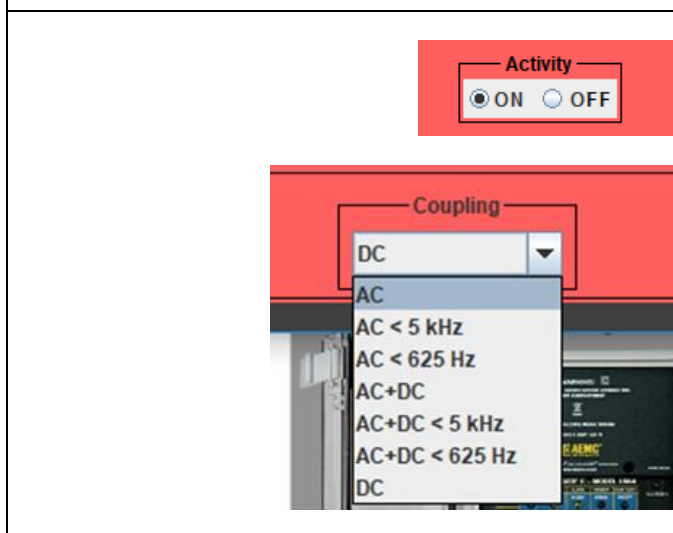

In MULTIMETER mode, the vertical configuration can be accessed by activating the channel (see top left).

In AUTO RANGE mode (default) you can select from among a set of ranges (white zone around the quantity) via the Coupling field (see lower left).

*Example: - channel 1 active, AUTO
- channels 2 and 3 inactive, AUTO
- channel 4 inactive, but adjustment of the voltage ranges is possible.*

OX 9304 Functional Description



File and backup management is performed on the PC. You can also store data in **ScopiX**. via USB.

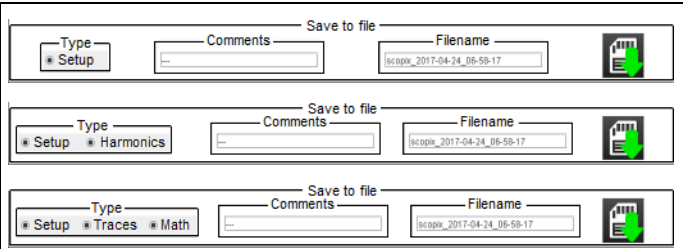

Backup in the various modes (Oscilloscope, Multimeter, Logger, Harmonic) is possible from the computer configuration files:

- "adjustments" for all modes
- "harmonics"
- "traces and math" for the oscilloscope mode

The backup is recorded in the **ScopiX** file system (internal or µSD Card).

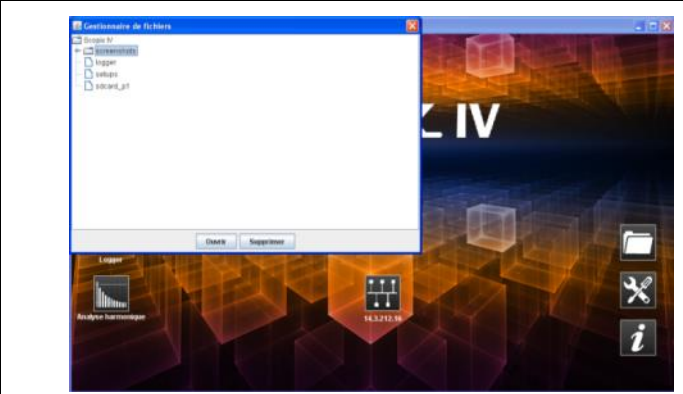

Files stored in **ScopiX** can be viewed from **ScopeNet**.

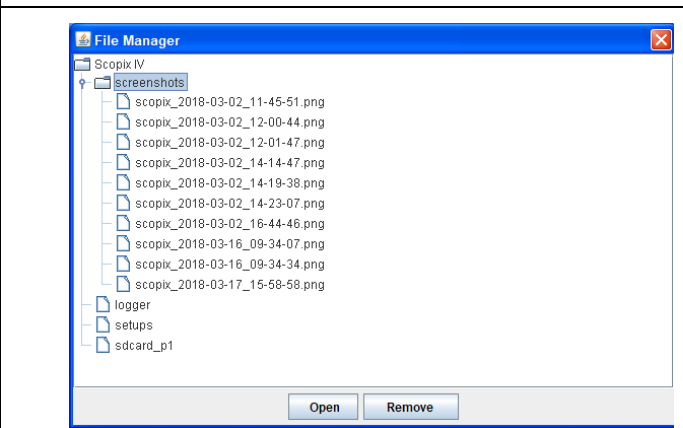

Files are recorded in the directory defined by the type of record.

5. WAVEFORM DISPLAY

5.1 Manual display



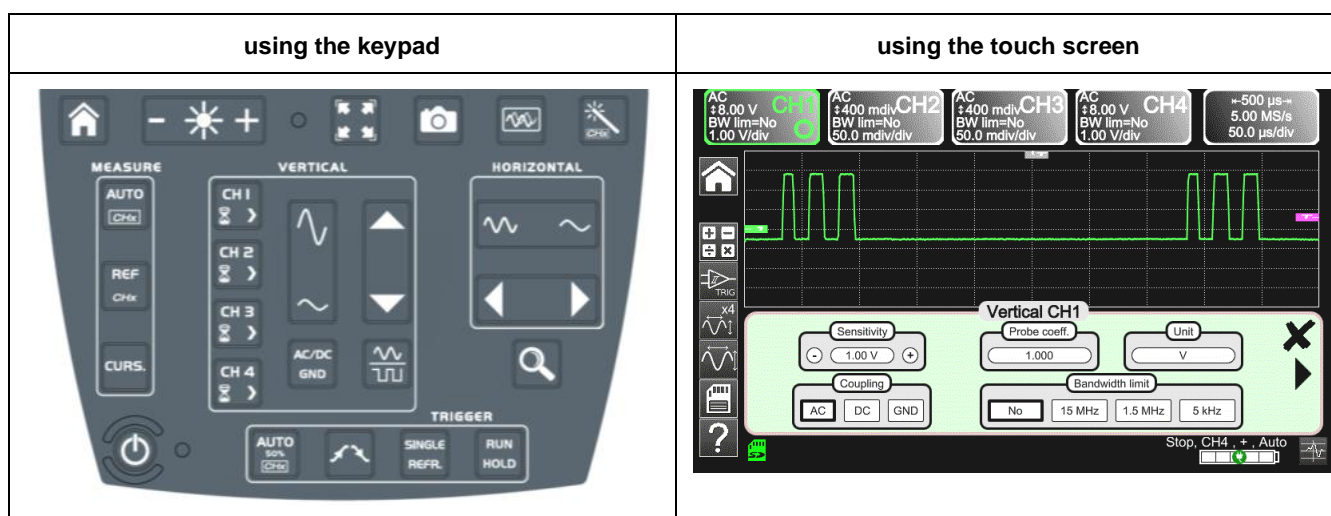

To view the signal and project it on the screen, be aware of the following characteristics:

- **Coupling:** note whether the signal is pure AC or has a DC component
- **amplitude** in Volts: defines the signal's amplitude on screen
- **frequency** or period of the signal: note whether or not it is repetitive
- **bandwidth:** the frequency related to the maximum frequency to measure





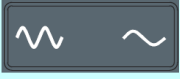



Once these characteristics are known, you can configure the channel to display the signal. There are two ways to do this:



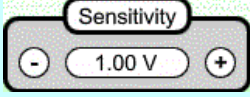
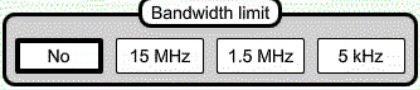

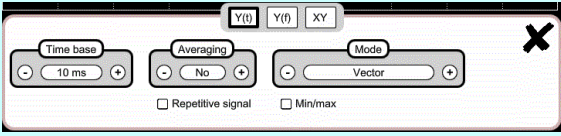
5.1.1. Using the keypad

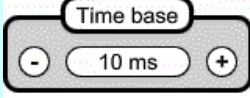
Key ↗	Action ↗
	1. Connect the Probix probe to a channel input.
	2. Press the channel key to refresh it and access configuration.
	3. Press this key to select coupling.
	4. Press this key to select the vertical sensitivity of the channel or its maximum amplitude visible on the screen.
	5. Press this key to select the desired time base of the channel or the maximum period visible on screen.
	6. Press this key to view signal.
	7. The signal appears.
 Note	It is not possible to configure the bandwidth of the signal from the keypad.









5.1.2. Using the touch screen

Icon ↗	Action ↗
	1. Connect the Probix probe to the channel input.
	2. Click the channel key  to refresh it ("channel activated") and access configuration.
	3. Select the coupling type.
	4. Press + or - to select the desired sensitivity of the channel or its maximum amplitude visible on screen.
	5. Select the type of bandwidth to obtain the desired limitation.
	6. Press  .
	7. Click the time base to access the adjustments.
	8. Click  .
	9. Ensure that only "roll" is checked.
	10. Select the duration of the time base with + or -.
	11. Press  .
	12. The signal appears.

5.2 Autoset

	The " Autoset " key projects the signal you want to display on the screen, along with its characteristics (refer to "manual" display, §4.1.3.). This enables you to optimize the signal with one click.
 Example	<p>1. Connect the Probix probe to the channel.</p> <p>2. Press the key above.</p> <p>3. The message AUTOSSET appears on the screen during the configuration process.</p> <p>This optimizes the display of the signal.</p>

5.3 Calibrating the probes

Step	Action 	
1.	Connect the Probix adapter of an HX0030 probe having a 1/10 ratio to the CH1 input.	
2.	Connect the probe (with its ground) to the calibrator output (Probe Adjust: $\approx 3V$, $\approx 1kHz$) on the side of the instrument.	
3.	Connect the cold of the probe to the cold of the calibration output of the probes.	
4.	Ensure the 1/10 coefficient of the probe has been taken into account.	<ul style="list-style-type: none"> Menu CH1 Click the right arrow, Measurement of probe, select Coefficient: 10, Validate by clicking  <p><i>Note: The sensitivity and the measurements take the coefficient of the probe into account.</i></p>
5.	Set the sensitivity of CH1.	<ul style="list-style-type: none"> Menu CH1, Sensitivity/coupling: 500mV/div or use buttons A and B of the HX0030 probe  <ul style="list-style-type: none"> or use the  keys.
6.	Set the coupling of CH1.	<ul style="list-style-type: none"> Menu CH1, coupling: AC  <ul style="list-style-type: none"> or use the key.
7.	Set the sweep rate.	<ul style="list-style-type: none"> Time base menu: 500μs/div  <ul style="list-style-type: none"> or or use the  keys
8.	Set the triggering parameters	<ul style="list-style-type: none"> Trigg menu: Source: CH1, Coupling: AC, + Edge 
9.	Set the triggering mode.	<ul style="list-style-type: none"> Trigg Menu by the SGLE REFR. key use the RUN HOLD key to start the acquisitions ("RUN" mode).

If necessary:

- Modify the triggering level with the stylus by moving the T (Trigger) symbol on the screen. The triggering level appears at bottom right on the screen.
- Modify the vertical position of the graph by using the stylus to move the 1 symbol, to the left of the screen.



The  key can be used to perform these adjustments automatically.

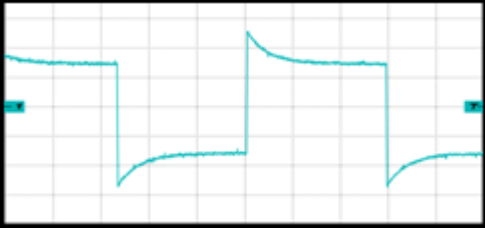
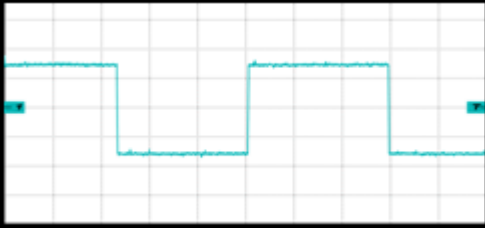
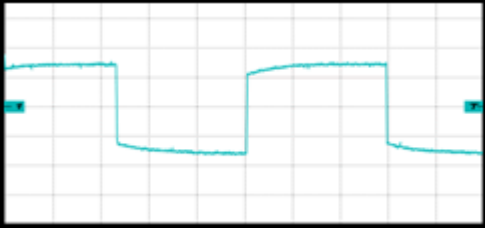

<p>Compensation of the HX0030 probe</p>	<p>Probix HX0030 compensation adjustment. For optimum response, use the knob at the top of the probe to adjust the low-frequency compensation of the probe so that the plateau of the signal is horizontal.</p>
<p><i>Probe overcompensated</i></p>	
<p><i>Probe correctly compensated</i></p>	
<p><i>Probe under-compensated</i></p>	

5.4 Auto/Cursors/Zoom measurement

5.4.1. Auto

For optimum measurement accuracy, we recommend displaying two complete periods of one or more signals. To do this, modify the time base using the "horizontal" keys.

- There are two ways to start **Auto** measurements in a channel:



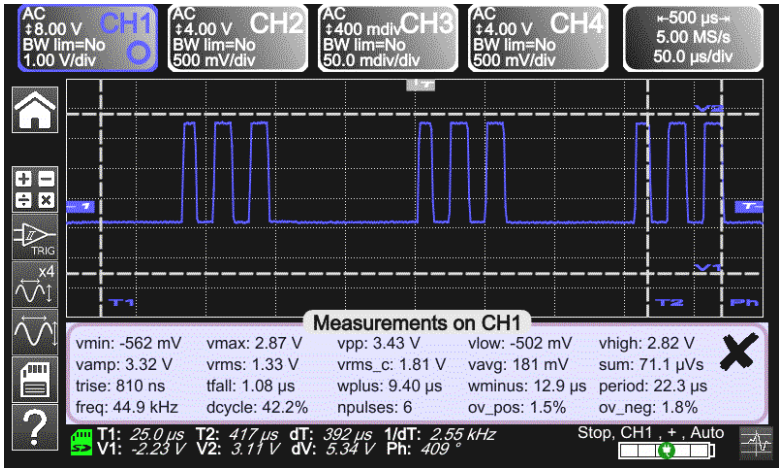

display the list of signals in this window:

- using the keypad: Press the channel key (1 to 4) and the icon shown on the left at the same time.
- using the touch screen: Press the icon shown to the left.



- To start **Auto** measurements in the 4 channels:



display the list of signals in this window:

- using the touch screen: Press the icon shown to the left.

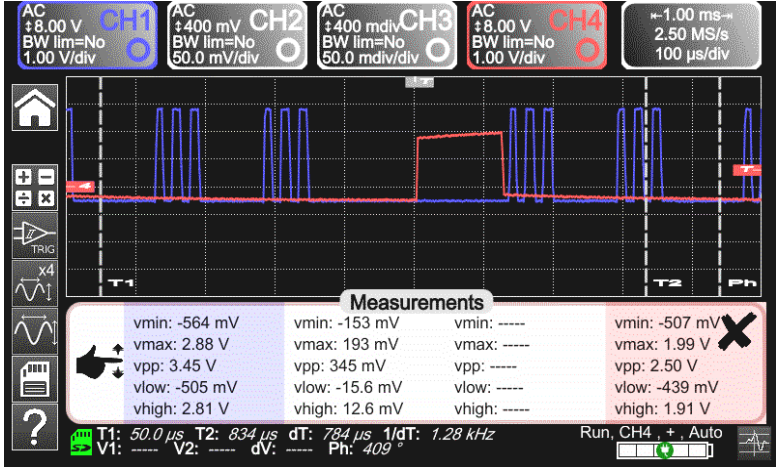

Auto Measurements list	Time measurements	Level measurements
	rise time	DC voltage
	fall time	RMS voltage
	positive pulse	peak-to-peak voltage
	negative pulse	amplitude
	duty cycle	max. voltage
	period	min. voltage
	frequency	upper plateau
	phase	lower plateau
	counting	overshoot
	integral	

5.4.2. Cursors

<p>3 categories of cursors (use the stylus to move them)</p>	<ul style="list-style-type: none"> Time cursors (T1 and T2) measure certain time values and calculate a delta and its frequency. Amplitude cursors (V1 and V2) measure amplitude values and calculate a delta. Phase cursor measures the phase of the signal according to the positioning of T1 and T2 and of a reference signal.
---	--

Measurements on CH1

vmin: -562 mV	vmax: 2.87 V	vpp: 3.43 V	vlow: -502 mV	vhigh: 2.82 V
vamp: 3.32 V	vrms: 1.33 V	vrms_c: 1.81 V	vavg: 181 mV	sum: 71.1 μ Vs
trise: 810 ns	tfall: 1.08 μ s	wplus: 9.40 μ s	wminus: 12.9 μ s	period: 22.3 μ s
freq: 44.9 kHz	dcycle: 42.2%	npulses: 6	ov_pos: 1.5%	ov_neg: 1.8%

The phase cursor is inactive if you are in Auto measurement mode in all channels.

5.4.3. Zoom

	<p>For more accurate measurements with the cursors, press the key to use the Zoom function. By default, the zoom is applied to the center of the current acquisition of the ScopiX. You can use the stylus to mark out a different zone.</p> <p> The time base is corrected according to the zoom applied.</p>
<p>Zoomed screen</p>	
	<p>Press this key again to exit from the Zoom function.</p>

5.5 Adjusting the Trigger

- Choose the triggering mode that corresponds to your application.
- Set the values of all triggering parameters.

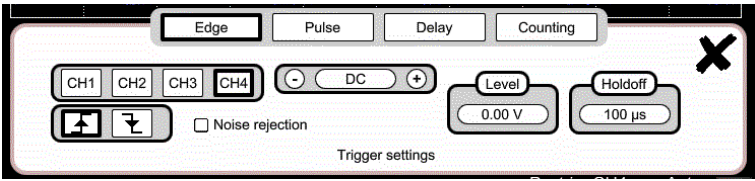
<p><i>Example:</i> Triggering on edge</p>	
<p>X</p>	<p>Exit from the window by clicking the cross.</p>

5.6. Mathematical/FFT/XY measurement

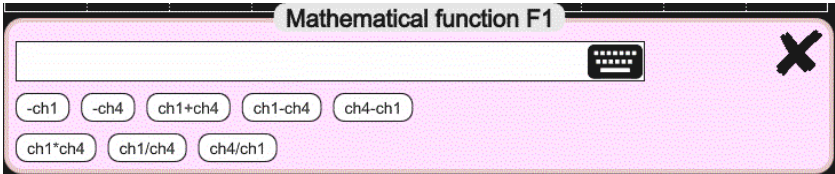
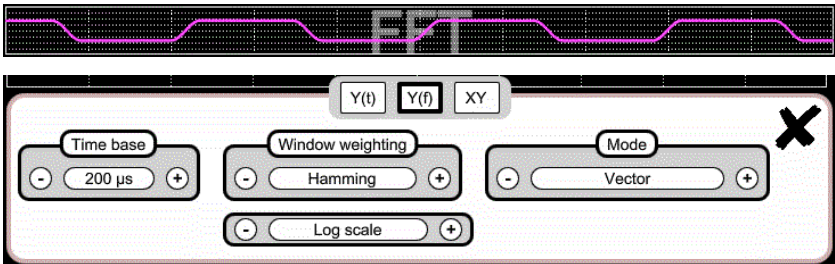
<p>Mathematical functions</p>	<p>These serve to process readings as a function of the settings configured on one of the channels of the instrument. These functions can be accessed using the key on the screen to specify the channel you want.</p> <p>A window appears that can be used to configure the mathematical function of this channel using the keypad or the predefined functions.</p> 
<p>FFT</p>	<p>The FFT (Fast Fourier Transform) function is activated via the time base menu by clicking it and selecting "Y(f)".</p>  <p>Parameters:</p> <ul style="list-style-type: none">▪ Time base in seconds▪ Weighting window: rectangular, hamming, hanning, blackman, flat top▪ Type of scale: logarithmic or linear▪ Mode: vector, envelope, whole acquisition, total

XY

This function is used to display one channel as a function of another.

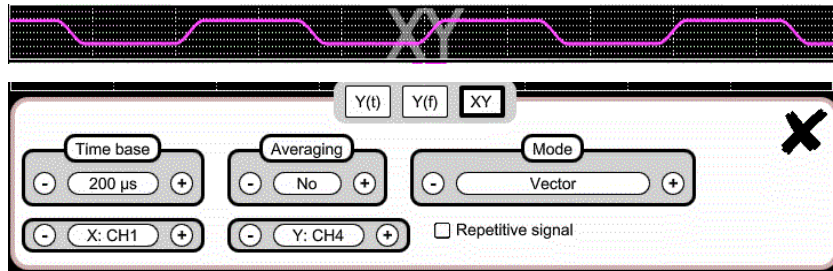

Parameters:

- Time base in seconds for channels X and Y
- Channel X or Channel Y
- Averaging: no, 2, 4, 16, 64
- Mode: vector, envelope, whole acquisition, total

The checkbox field "Repetitive signal" selects whether or not the signal is repetitive (sign wave, square wave, and so on).

6. MULTIMETER MEASUREMENT



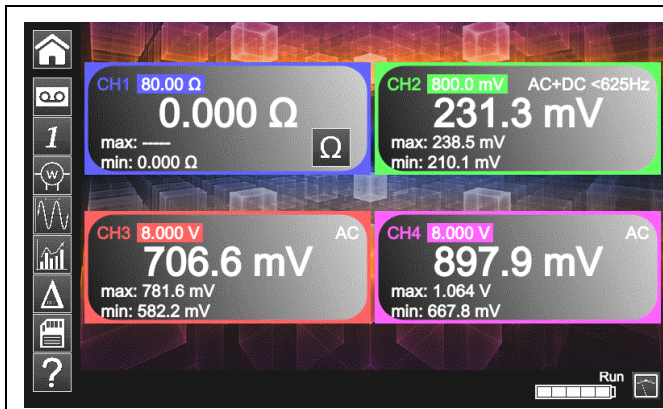



6.1 Differentiating channels













Channel 1 of the **ScopiX** is named CH1. It measures various physical quantities in addition to the signal amplitude measurements, using the appropriate **Probix** accessories. The other channels are voltmeter channels only (or current channels, when used with a **Probix** clamp).

6.2 Measurement type

Measurements	CH1	CH2	CH3	CH4
Voltage	✓	✓	✓	✓
Current	✓	✓	✓	✓
Resistance	✓			
Capacitance	✓			
Diode test	✓			
Continuity	✓			
Power	✓	✓	✓	✓
Temperature by Pt100	✓	✓	✓	✓

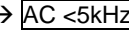
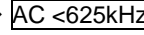
By clicking 	You can 
	Display the frequency, in the case of an AC amplitude measurement, as a secondary measurement performed on each channel.
	Display the Min and Max values of the measurements made, as a secondary measurement on each channel.
	Display the relative values of the measurements made, as a secondary measurement on each channel.
	Save your configurations, by entering their properties.

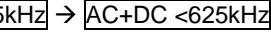
 Remarks	
	The channels of the measurement ranges are automatic. To define the measurement range in manual mode, press the  key.
	A long press on the channel key return to automatic mode. In addition: <ul style="list-style-type: none"> ▪ In automatic mode, the measurement range on the screen is highlighted in the color of the channel. ▪ In manual mode, it is not.
	The coupling of the channels can be modified using the  key:  →  →  →  →  →  → 





6.3 Power measurement

To measure power, you must have the right **Probix** accessories:

- current measurements: **HX0034**, **HX0072**, and **HX0073** clamps
- voltage measurements: **HX0033** banana adapter and leads



Click the  icon to make a power measurement in Multimeter mode. Then, select the type of set-up you want to measure:

	Single-phase power	Displays the result of calculation of the active power, measured using CH1 for the voltage measurement and CH4 for the current measurement.
	Three-phase power on balanced network without neutral	Displays the active three-phase power calculated from the wiring proposed at the time of selection.
	Three-phase power on balanced network with neutral	Displays a value equal to 3x the active power measured on one phase.
	Three-phase power, 3 wires	Displays active three-phase power measured by the two-wattmeter method on an installation without neutral.

When the values are read in this mode, the following screen is displayed:  *Example*: Single-phase power

	<p>← Channel 1 indicates the voltage measured directly with its min and max values.</p> <p>← Channel 4 indicates the current measured directly with its min and max values.</p> <p>← The various power values calculated from channels 1 and 4 are displayed, along with their power factor.</p> <p> <i>The type of wiring is indicated next to the values.</i></p>
--	--

6.4 LOGGER mode

This function of Multimeter mode records values read on the various channels of the **ScopiX**, whatever the type of measurement.

 **The records may be long. We suggest connecting ScopiX to external power to avoid measurement stoppage when the battery is depleted.**

When you click , the screen below is displayed and recording starts:

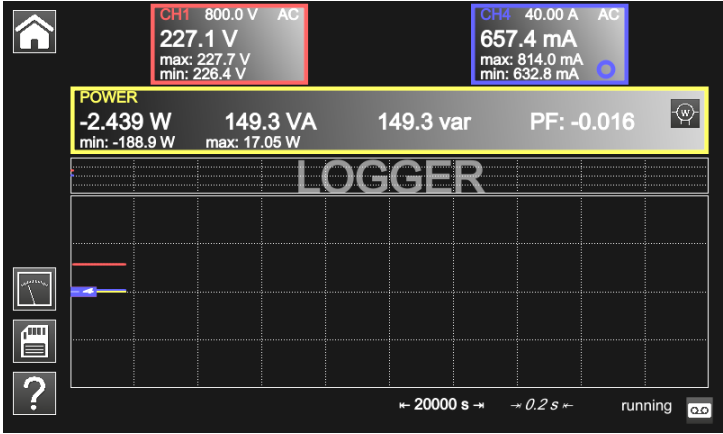

Each recording file contains 100,000 measurements per channel, at a rate of one measurement every 0.2 sec for 20,000 sec (approx. 5h30').

- If a recording exceeds 100,000 measurements, **ScopiX** automatically generates a second measurements file that continues where the preceding file ended.
- If the second measurement file reaches 100,000 measurements, a third file is created, and so on until you decide to stop the acquisition or the memory available for the files is full.



Backs up the current configuration. The window below is displayed:

You can enter:

- a configuration name
- remarks
- save it in .cfg format

by clicking the green arrow.

Type
Save to File

Setup Meas.

Comment --- 







File: scopix_2018-02-28_10-19-22 

 **The max. internal memory is 1GB.**

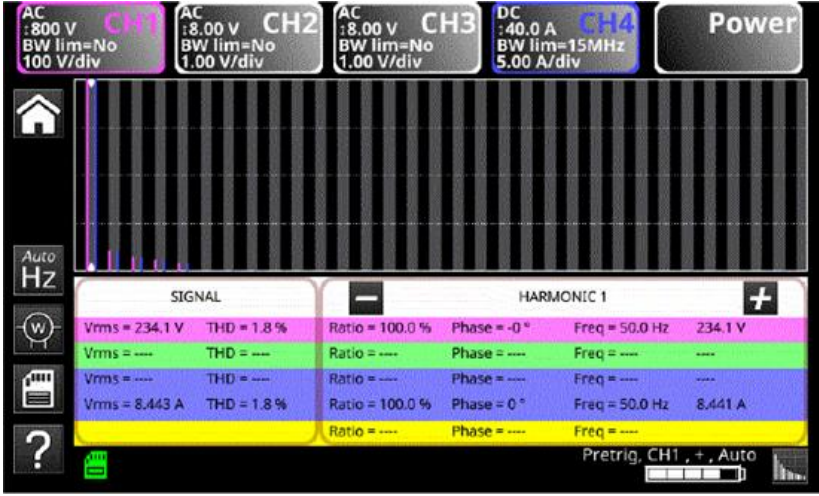
 To return to the Multimeter mode, click .

7. HARMONICS ANALYSIS

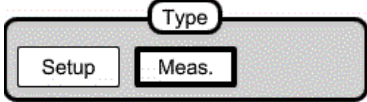
	 <p>The screenshot shows a power quality analyzer interface. At the top, there are four channel settings: CH1 (AC, 800 V, BW lim=No, 100 V/div), CH2 (AC, 8.00 V, BW lim=No, 1.00 V/div), CH3 (AC, 8.00 V, BW lim=No, 1.00 V/div), and CH4 (DC, 40.0 A, BW lim=15MHz, 5.00 A/div). Below the settings is a spectrum plot showing a dominant peak at 50.0 Hz. A data table is displayed below the plot, showing the following values:</p> <table border="1"> <thead> <tr> <th colspan="2">SIGNAL</th> <th colspan="4">HARMONIC 1</th> </tr> </thead> <tbody> <tr> <td>Vrms = 234.1 V</td> <td>THD = 1.8 %</td> <td>Ratio = 100.0 %</td> <td>Phase = -0 °</td> <td>Freq = 50.0 Hz</td> <td>234.1 V</td> </tr> <tr> <td>Vrms = ---</td> <td>THD = ---</td> <td>Ratio = ---</td> <td>Phase = ---</td> <td>Freq = ---</td> <td>---</td> </tr> <tr> <td>Vrms = 8.443 A</td> <td>THD = 1.8 %</td> <td>Ratio = 100.0 %</td> <td>Phase = 0 °</td> <td>Freq = 50.0 Hz</td> <td>8.441 A</td> </tr> <tr> <td>Vrms = ---</td> <td>THD = ---</td> <td>Ratio = ---</td> <td>Phase = ---</td> <td>Freq = ---</td> <td>---</td> </tr> </tbody> </table>	SIGNAL		HARMONIC 1				Vrms = 234.1 V	THD = 1.8 %	Ratio = 100.0 %	Phase = -0 °	Freq = 50.0 Hz	234.1 V	Vrms = ---	THD = ---	Ratio = ---	Phase = ---	Freq = ---	---	Vrms = 8.443 A	THD = 1.8 %	Ratio = 100.0 %	Phase = 0 °	Freq = 50.0 Hz	8.441 A	Vrms = ---	THD = ---	Ratio = ---	Phase = ---	Freq = ---	---
SIGNAL		HARMONIC 1																													
Vrms = 234.1 V	THD = 1.8 %	Ratio = 100.0 %	Phase = -0 °	Freq = 50.0 Hz	234.1 V																										
Vrms = ---	THD = ---	Ratio = ---	Phase = ---	Freq = ---	---																										
Vrms = 8.443 A	THD = 1.8 %	Ratio = 100.0 %	Phase = 0 °	Freq = 50.0 Hz	8.441 A																										
Vrms = ---	THD = ---	Ratio = ---	Phase = ---	Freq = ---	---																										
	<p>You can change the displayed harmonic using the + and - keys.</p> <p>The following values are displayed:</p> <ul style="list-style-type: none"> ▪ value in % of the harmonic of greatest amplitude ▪ phase in ° with respect to the fundamental ▪ frequency in Hz ▪ RMS voltage in V 																														
	<p>You use this key to save these settings:</p> <ul style="list-style-type: none"> ▪ Click Setup. ▪ Press . A field appears for entering the filename. Complete this field to save the data in memory. 																														
	<p>You use this key to save these settings:</p> <ul style="list-style-type: none"> ▪ Click Meas. 																														

8. TECHNICAL SPECIFICATIONS

8.1. Oscilloscope function

Only the assigned tolerance or limit values are guaranteed values (after a half-hour warm-up period).
The values without tolerances are given as an indication.

Vertical deflection

Characteristics	OX 9062	OX 9102 OX 9104	OX 9304
Number of channels ¹	2	OX 9xx2: 2, OX 9xx4: 4	
Vertical ranges	2.5mV to 200V/div. Variation in steps (no continuously variable coefficient)		
BW to 3dB down	60MHz	100MHz	300MHz
	Measured into a 50Ω load with a signal having an amplitude of 6 div.		
Max. input voltage ²	1400 VDC, 1kVrms with the Probix HX0030 probe		
Types of input	Probix safety connector: class 2, isolated inputs		
Dynamic of the vertical offset	±10 divisions in all ranges		
Input coupling	AC DC GND	10Hz to 60MHz 0 to 60MHz reference	10Hz to 100MHz 0 to 100MHz reference
			10Hz to 300MHz 0 to 300MHz reference
Bandwidth limiters	at ≈15MHz, 1.5MHz, 5kHz		
Rise time in all vertical ranges. 2.5mV to 200V/div.	≈5.85ns	≈3.5ns	≈1.17ns
Cross-talk between channels	>70dB (Same sensitivity in both channels)		
Response to rectangular signals at 1kHz and 1MHz	Positive or negative overshoot Overshoot ≤ 4%		
Vertical resolution of the display	±0.4% of full scale (without ZOOM) 0.025% in ZOOM mode (12 bits)		
Accuracy of the peak-to-peak gains	±2% with averaging from 4 to 1kHz		
Accuracy of the vertical measurements in DC with offset and averaging over 16	±[2.2% (reading) + 11% (sensitivity) + 400 μV] applies to the following measurements: Vmin, Vmax, Vlow, Vhigh, Vavg, curs(1), curs(2)		
Accuracy of the vertical measurements in AC without offset at 1kHz with averaging over 16	±[2% (reading) + 1% (sensitivity)] applies to the following measurements: Vamp, Veff, Dep+, Dep-		
Resolution of the measurements	12 bits		
Accuracy of the vertical offset	±[0.2% (reading) + 10% (sensitivity) + 400 μV]		
Vertical ZOOM function on an acquired or saved graph	ZOOM factors: 16 max.		
Input impedance	1 MΩ ±0.5% approx. 12 pF		

¹ Instruments with two channels: CH1 and CH4, instruments with four channels: CH1, CH2, CH3, CH4

² Refer to the figure (§ 9.4.2.): max. input voltage as a function of frequency

Horizontal deflection (time base)

Characteristics	OX 9062 - OX 9102 - OX 9104 - OX 9304
Time base ranges	35 ranges, from 1ns to 200s/div.
Accuracy of the time base	$\pm[0.0005\% + \max(500\text{ps}, 1 \text{ sample})]$
Sampling frequency	2.5GS/sec. in real time 100GS/sec. on repetitive signal
Accuracy of the time measurements	$\pm[(0.02 \text{ div.}) \times (\text{time/div.}) + 0.01 \times \text{reading} + 1\text{ns}]$
Horizontal ZOOM	Zoom coefficient: x1 to x100 The oscilloscope has a memory capacity of 100,000 pts per channel.
	In ZOOM mode, the sequence of time base ranges is the same as in the normal mode. <i>The horizontal resolution of the screen is 2500 points for 10 divisions.</i>
XY mode	The bandwidths are the same in X and in Y. <i>As in standard mode, the sampling frequency depends on the time base.</i>
Phase error	$<3^\circ$
Representation Fast Fourier Transform	In time or frequency domain (FFT) <ul style="list-style-type: none"> ▪ calculation on the displayed traces ▪ dynamic refresh according to the signal observed in RUN mode ▪ windowing: rectangle, hamming, Hanning, Blackman ▪ scales: logarithmic or linear ▪ automatic adjustment via autoset

Triggering circuit

Characteristics		OX 9062	OX 9102 OX 9104	OX 9304
Triggering sources		CH1, CH4	CH1, CH2, CH3, CH4 (OX 9xx4) CH1, CH4 (OX 9102)	
Triggering mode		Automatic Triggered Single-shot Auto Level 50%		
BW on triggering without band limitation	AC	10Hz to 100MHz	10Hz to 200MHz	≥10Hz
	DC	0Hz to 100MHz	0Hz to 200MHz	0Hz to BW max ³
	HF reject	0Hz to 10kHz	0 to 10kHz	0 to 10kHz
	BF reject	10kHz to 100MHz	10kHz to 200MHz	≥10kHz
		<i>If bandwidth limitation is activated, the BW of the triggering is also reduced.</i>		
Triggering slope		Negative- or positive-going edge		
Triggering sensitivity		0.6 div. (0Hz to 50MHz) 1.2 div. (50MHz to 100MHz)	0.6 div. (0Hz to 50MHz) 1.2 div. (50MHz to 200MHz)	0.6 div. (0Hz to 50MHz) 1.2 div. (50MHz to 200 max.) 1.5 div. (200MHz to BW max.)
Noise rejection		≈ ±1.5 div.		
Triggering level Range of variation		±10 div.		
Type of triggering		on edge	Triggering source: CH1 (CH2) (CH3) CH4	
		on pulse width	<T1; >T2; ∈ [T1, T2]; ∉ [T1, T2] with T1 and T2 ∈ [16ns, 20 s]	
		triggering after delay	<ul style="list-style-type: none"> ▪ from 48ns to 20s ▪ Source of qualifier: CH1 (CH2) (CH3) CH4 ▪ Triggering source: CH1 (CH2) (CH3) CH4 	
		triggering after counting	<ul style="list-style-type: none"> ▪ from 3 to 16,384 events ▪ Source of qualifier: CH1 (CH2) (CH3) CH4 ▪ Counting source: CH1 (CH2) (CH3) CH4 ▪ Triggering source: source of the qualifier or of the counting 	
Holdoff		Adjustable from 64ns to 15 sec.		

³ BW max: maximum bandwidth determined by the vertical sensitivity of the channel

Acquisition system	
Characteristics	OX 9062 - OX 9102 - OX 9104 - OX 9304
ADC Resolution	12 bits
Maximum sampling frequency	2.5GS/s in real time 100GS/s with repetitive signal (ETS) according to time base 1 converter per channel
Transient Capture MIN/MAX mode	Minimum width of transients that can be detected: ≥ 2 ns
	In the range [1ns 5ms]: 1250 MIN/MAX couples stored in 100,000-pt acquisition memory. In the range [20ms 200s]: 50,000 MIN/MAX couples
Depth of acquisition memory reconstituted	100,000 pts per channel
PRETRIG	0-9.5 div. 0-950 div. (zoom)
POSTRIG	0-20 div. 0-2000 div. (zoom)

File formats	
Characteristics	OX 9062 - OX 9102 - OX 9104 - OX 9304
Backup memory	Local file system. The user's files are stored in a specific partition. System of files on μ SD Card. The partitions of the μ SD Card can be accessed in the sdcard_pX directory of the local file system.
Size of memory available for the file system	<ul style="list-style-type: none"> ■ Internal memory of the instrument: 1GB ■ with μSD Card of type SC (≤ 2GB), HC (>2GB ≤ 32Go) or XC (>32GB ≤ 2TB) with its partition(s) formatted in FAT32
The files of traces acquired in SCOPE mode Extension: .trc	Binary format Size: ≈ 400 kB per trace stored (max: 1.6MB)
The files of traces acquired in LOGGER mode Extension: .rec	Binary format Size: ≈ 400 ko per trace stored (max: 1.6Mo)
Configuration files Extension: .cfg	Binary format Size: ≈ 1 ko
Printing files Extension: .png	Size: <200 ko
Files of mathematical functions Extension: .fct	Text format Size: <1 ko
Files containing text Extension: .txt	Text format Files with the .TXT extension can contain measurements made in the instrument's various acquisition modes.
.txt file containing measurements made in HARMONIC mode	Size: <10 ko

Measurement processing

Mathematical functions	Equation editor (functions on the channels or simulated functions): Addition, subtraction, multiplication, division, and complex functions between channels.	
Automatic measurements	Time measurements rise time fall time positive pulse negative pulse duty cycle period frequency phase counting integral	Level measurements DC voltage RMS voltage peak-to-peak voltage amplitude max. voltage min. voltage upper sup. lower plateau overshoot
Resolution of the measurements	12 bits/display on 4 digits	
Measurements by cursors or automatic measurements <i>Accuracy of vertical measurements in DC</i> <i>Accuracy of time measurements with 2 cursors</i>	$\pm[1\% \times (\text{reading} - \text{offset}) + \text{accuracy of the vertical offset} + (0.05 \text{ div.}) + (V/\text{div.})]$ $\pm[0.02 \times (t/\text{div.}) + 0.01\% (\text{reading}) + 1 \text{ ns}]$ In XY mode, the cursors are not attached to the graph.	

Display	
Characteristics	OX 9062 - OX 9102 - OX 9104 - OX 9304
Display screen	LCD 7" TFT (color display) Backlighting by LEDs
Brightness	Continuous adjustment
Resolution	WVGA, or 800 pixels horizontally x 480 pixels vertically
Screen saver	Choice of delays: 15', 30', 1h, or none
Display without Zoom	Complete memory: 100,000
Horizontal ZOOM	2500 pts out of the 100,000 of the complete memory
Display modes	<p><i>Vector</i> Points acquired, points interpolated, average. Linear interpolation between 2 acquired pts.</p> <p><i>Envelope</i> Display of the min. and of the max., on each abscissa, acquired on several bursts.</p> <p><i>Average</i> Over: no averaging, 2, 4, 16, 64</p> <p><i>The entire acquisition</i> Display of all samples acquired in a burst with linear interpolation between 2 acquired points.</p>
Screen indicators	<p><i>Triggering</i> Position of the triggering level (with coupling and overshoot indicator) Position of the Trigger point on the bargraph and on the top edge of the screen (with overshoot indicators)</p> <p>Identifiers of traces, activation of the traces Position, Sensitivity Ground reference</p> <p><i>Traces</i> High and low overshoot indicators, if traces outside screen</p>
Various	
Signal for calibration of the 10:1 probes	<p>Form: rectangular Amplitude: $\approx 0-3V$ Frequency: $\approx 1kHz$ <i>Connect the cold of the probe to the cold of the calibration output of the probes.</i></p>
Autoset	<p><i>Search time</i> <5s <i>Frequency range</i> >30Hz <i>Amplitude range</i> 15mVpp to 400 Vpp <i>Limits of duty cycle</i> from 20 to 80%</p>

8.2 Multimeter and LOGGER functions

Only the assigned tolerance or limit values are guaranteed values (after a half-hour warm-up period).
The values without tolerances are given as an indication.

Display	8,000 points as voltmeter				
Input impedance	1M Ω				
Max. input voltage	600 Vrms sine and 800 VDC without probe 1000 Vrms and 1400 VDC with HX0030 probe				
DC measurement					<u>HX0030</u>
<i>Ranges</i>	0.8V	8V	80V	800V	8kV
<i>Resolution</i>	0.1mV	1mV	10mV	0.1V	1V
<i>Accuracy</i>	$\pm (0.5\% + 25 D)$ in DC from 10% to 100% of the scale				
<i>Common mode rejection</i>	>70dB at 50 or 60 or 400Hz				
AC and AC+DC measurements					<u>HX0030</u>
<i>Ranges</i>	0.6V 0.8V	6V 8V	60V 80V	600 Vrms sine 800 Vpeak	6kVrms 8kVdc
<i>Resolution</i>	0.1mV	1mV	10mV	0.1V	1V
<i>Accuracy in coupling AC + DC Filters inactive</i>	$\pm (1\% + 25 D)$ from DC to 1kHz				from 10% to 100% of the scale (peak)
	$\pm (2\% + 25 D)$ from >1kHz to 10kHz				id.
	$\pm (3\% + 25 D)$ from >10kHz to 200kHz				id.
<i>AC Filters inactive</i>	$\pm (1\% + 25 D)$ from 40Hz to 1kHz				id.
	$\pm (2\% + 25 D)$ from >1kHz to 10kHz				id.
	$\pm (3\% + 25 D)$ from >10kHz to 200kHz				id.
<i>Common Mode Rejection</i>	>70dB at 50, 60 or 400Hz				
<i>Digital filter</i>	<ul style="list-style-type: none"> ■ Low-pass filter ■ Cutoff frequency 625Hz ■ Order 94 ■ Bandwidth ripple 0.5dB ■ Transition band 0.02 ■ Stopband attenuation 50dB 				

Technical Specifications

Resistance measurement	<i>In Channel 1</i>		
<i>Ranges (full scale)</i>	Ohmmeter	Resolution	Measurement current
	80Ω	0.01Ω	500μA
	800Ω	0,1Ω	50μA
	8kΩ	1Ω	50μA
	80kΩ	10Ω	2μA
	800kΩ	100Ω	2μA
	8MΩ	1000Ω	50nA
	32MΩ	10kΩ	50nA
<i>Accuracy</i>	±(0.5% + 25 D) from 10% to 100% of the scale		
<i>Open-circuit voltage</i>	≈3V		
Continuity measurement	<i>In Channel 1</i>		
<i>Beeper</i>	<30Ω ±5Ω		
<i>Measurement current</i>	≈0.5mA		
<i>Beeper response</i>	<10ms		
Diode test	<i>In Channel 1</i>		
<i>Voltage</i>	Open-circuit: ≈ + 3.3V		
<i>Accuracy</i>	±(0.5% + 5 D)		
<i>Measurement current</i>	≈ 0.6mA		
Capacitance measurement	<i>In Channel 1</i>		
<i>Ranges</i>	Capacitance meter	Resolution	Measurement current
	5mF	1μF	500μA
	500μF	0.1μF	500μA
	50μF	0.01μF	500μA
	5μF	1nF	50μA
	500nF	100 pF	50μA
	50nF	10 pF	2μA
	5nF	1 pF	2μA
<i>Accuracy</i>	<ul style="list-style-type: none"> ▪ 5nF range (measurement with a shielded lead): <ul style="list-style-type: none"> from 500 pF to 1nF: ±(6% +10 D) from >1nF to 2nF: ±(4% +10 D) >2nF: ±(2% +10 D) ▪ other ranges: ±(2% +10 D) from 10% to 100% of full scale 		
<i>Cancellation of series and parallel R</i>	parallel R >10 k Use the shortest possible leads.		
Frequency measurement	20Hz to 200kHz on a square- and sine-wave signal 20Hz to 20kHz on a triangular signal Accuracy: 0.2%		
Power measurement	The power measurement is available only in AC, AC<5kHz, and AC <625 Hz.		
<i>active</i>	± (2% +25 D) from 40 to 1kHz, filters inactive		
<i>reactive</i>	± (4% +25 D) from 1 to 10kHz, filters inactive		
<i>apparent</i>	± (6% +25 D) from 10 to 200kHz, filters inactive		

Operating modes

<i>Relative mode</i>	Display with respect to a base measurement	The Relative, Surveillance, and Frequency modes are mutually exclusive.
<i>Surveillance (statistical)</i>	On all measurements in MAX MIN value	
<i>Frequency</i>	The frequency can be displayed in AC mode	
<i>Interval of time between 2 measurements</i>	0.2s	
<i>Duration of the records (LOGGER mode)</i>	Each file contains 100,000 measurements, or an acquisition time of 20,000 seconds. Automatic sequential recording (N files of 100,000 measurements)	
<i>RUN (MULTIMETER mode)</i>	Measurements started	
<i>HOLD (MULTIMETER mode)</i>	Measurement frozen	

Display

<i>In digital form</i>	<ul style="list-style-type: none"> ■ main measurement: large display ■ secondary measurement: small display <p>The type of secondary measurement can be selected in the menu.</p>
<i>Graphic plot (LOGGER mode)</i>	History of measurements over time
<i>Number of measurements represented on a trace</i>	100,000

8.3. VIEWER function

The **VIEWER** function reads a file acquired in **LOGGER** mode.

Horizontal zoom	Zoom coefficient: x1 to x100 The oscilloscope has a memory capacity of 100,000 pts per channel.
Vertical zoom	ZOOM factors: maximum 16
Accuracy of measurements by cursors, vertical	$\pm [1\% \times (\text{reading} - \text{offset}) + \text{accuracy of the vertical offset} + (0.05 \text{ div.}) + (V/\text{div.})]$
Accuracy of measurements by cursors, time	$\pm [0.02 \times (t/\text{div.}) + 0.01\% (\text{reading}) + 1 \text{ ns}]$

8.4. HARMONIC ANALYSIS function

- Displays harmonics in bargraph form
- Crosshair with vertical axis graduated in %
- Horizontal axis graduated in orders of harmonic
- Displays 63 orders
- The harmonic analysis function can be implemented on the 4 channels
- Displays measurements:
 - RMS level of the signal
 - total harmonic distortion (THD) with respect to the RMS value of the fundamental
 - RMS level of the harmonic selected
 - ratio in % of the RMS value of the selected harmonic to the RMS value of the fundamental
 - frequency of selected harmonic
 - phase of selected harmonic/fundamental

Harmonic analysis		
Frequency of the fundamental of the signal analyzed	from 40 to 450Hz	Condition
Accuracy of the measurements	In the domain of reference: 64 to 82°F (18 to 28°C), at 50Hz and 60Hz	
<i>Level of the Fundamental</i>	±(2% + 10 D)	
<i>Level of the Harmonics</i>	±(3% + 10 D), ratio ±2%	ratio >4%
<i>Harmonic distortion (THD)</i>	±4%	
<i>Phase</i>	±5%	ratio >4%
Variations in the nominal range of use	32 to 104°F (0 to 40°C), at 50Hz and 60Hz	
<i>Level of the Fundamental</i>	±(5%/18°F [10°C])	
<i>Level of the Harmonics</i>	±(5%/18°F [10°C]), ratio ±(1%/18°F [10°C])	ratio >4%
<i>Harmonic distortion (THD)</i>	±(5%/18°F [10°C])	
<i>Phase</i>	±(10°/18°F [10°C])	ratio >4%

8.5. Communication

8.5.1. Communication port and peripherals

ETHERNET	100Base-T, electrically isolated (peripheral) 600V, CAT III isolation is implemented inside the instrument. ETHERNET isolation by transformer USB isolation by logical isolator
WIFI	WEP, WPA
USB	Electrically isolated CDC (Communication Device Class) ACM (Abstract Control Model) protocol to submit SCPI queries MS (Mass Storage) protocol to manage the SCOPIX IV file system (and its μ SD card). RNDIS (Remote Network Driver Interface Specification) to communicate via USB using the TCP/IP protocol.
SDCARD	Transfer files between the scope and a computer by memory card, Micro SD format (type SC, HC, or XC). The supported file system is FAT32.

8.5.2. Applications

SCOPENET	Accessible via ETHERNET, WIFI, or USB using a browser. To access, type the following line in the navigation bar of: FIREFOX/CHROME/EXPLORER: http://<IP address>  Example: http://192.168.1.1 This application uses IP ports 50 000 and 50 010 (it may be necessary to update your computer's Firewall).
Access to the file system from a PC	via USB: using the RNDIS protocol (and the corresponding driver)
SCPI	via USB: using the CDC ACM protocol (and the corresponding driver) via ETHERNET: on port 23 via WIFI: on port 23

9. GENERAL SPECIFICATIONS

9.1. Nominal range of use

9.1.1. Environmental conditions

Reference temperature: 64 to 82°F (18 to + 28°C)
 Operation temperature: 32 to 104°F (0 to + 40°C)
 Storage temperature: -4 to 158°F (-20 to + 70°C)
 Relative humidity: <80% RH → 95°F (35°C); <70% from 95 to 104°F (35 to 40°C)
 (limited to 70% in the 8MΩ and 32MΩ ranges)
 Altitude: <6500' (<2000m)

9.1.2. Variations in the nominal range of use

Quantities of influence	Range of influence	Quantity influenced	Error	
			Typical	Max.
Battery voltage	9.4V to 12.6V	All	-	-
Temperature	32 to 104°F (0 to + 40°C)	<u>Oscilloscope</u> Vertical gain Position Triggering level Automatic measurements	±0.5% per 18°F (10°C)	±1% per 18°F (10°C)
		Time base	±0.1% per 18°F (10°C)	±0.2% per 18°F (10°C)
	32 to 104°F (0 to + 40°C)	Bandwidth, overshoot	±2.5% per 18°F (10°C)	±5% per 18°F (10°C)
	32 to 104°F (0 to + 40°C)	<u>Multimeter</u> DC measurements	±0.5% per 18°F (10°C)	±1% per 18°F (10°C)
		AC+DC	±0.5% per 18°F (10°C)	±1% per 18°F (10°C)
		Measurement of resistance of diodes of capacitance	±0.5% per 18°F (10°C)	±1% per 18°F (10°C)
		Frequency counter	±0.1% per 18°F (10°C)	±0.2% per 18°F (10°C)
	32 to 104°F (0 to + 40°C)	<u>Measurements of harmonics of the network</u> Fundamental Harmonics Distortion	±3% per 18°F (10°C)	±5% per 18°F (10°C)
		Phase	±5° per 18°F (10°C)	±10° per 18°F (10°C)
Electromagnetic field	10V/m	<u>Oscilloscope</u> Vertical noise	5mV _{pp}	7.5mV _{pp}
		<u>Ohmmeter</u> Measurements	0 - 2%	5% of full scale
Humidity	0% to 70%	<u>All measurements</u>	-	-
Temperature	70% to 80%	<u>All measurements from 32 to 95°F (0 to 35°C) except 8 MΩ and 32 MΩ ranges</u>	-	-

9.1.3. Power supply

Battery voltage: >9.5V; 10.8V nominal
 or external power: connected to network at 230V ± 15%, 50Hz
 or 110V ± 15%, 60Hz
 (therefore operates from 98V to 264V).

9.2. Mechanical specifications

9.2.1. Case covered with elastomer

Components:

- lower housing
- central belt holding all terminations
- upper housing
- battery compartment cover
 - Dimensions: 11.5 x 8.3 x 2.6" (292.5 x 210.6 x 66.2mm)
 - Weight: approximately 5.3 lbs (2.4 kg) with the battery
 - Carrying strap: snaps onto the top of the instrument

9.2.2. Mechanical conditions

- **Waterproofing**
Resistant to drops of water falling vertically and penetration of objects $\geq 1\text{mm}$: IP 54 (instrument not in operation).
Instrument alone, without accessories or external power supply, upright, tilted 40° on its prop or flat with LCD up.

 **Remarks:**

1. ***Do use not the instrument in locations with carbon dust, metallic dust, or other conducting dust in the air.***
 2. ***Wipe the instrument, in particular the measurement terminals, after each use.***
- **Shocks and impacts**
Per test standards IEC 62262: IK03 (LCD screen) and IK06 (any other part of the instrument).
3 impacts with a force of 1 Joule (IK06) or 0.35 Joule (IK03), applied to each component part of the instrument, without deterioration that might create a risk for the safety of the user.
 - Free **fall**, without packaging.
Instrument alone, without accessories, on 3 sides.
Per the test standards of IEC 61010-1-2010.

9.3. Electrical specifications

9.3.1. Battery power supply

- Li-Ion technology
- Nominal voltage: 10.8V
- Operating voltage: 10V to 12V
- Capacity: 5800mAh/62 Wh
- Battery protected from short circuits by resettable fuse
- Life between charges
 - 5h30min for the two-channel models
 - 4h for the four-channel models
- Charging time: ≤ 7 hours depending on charger type

9.3.2. Line power

- DC supply, approximately 15V, 30W for instrument operation
- DC supply, approximately 11V, 15W to charge the battery
- Primary circuit characteristics: $98V < \text{Input voltage} < 264V$
- Therefore operates on the following networks:
 - 230V, $\pm 15\%$, 50Hz
 - 115V, $\pm 15\%$, 60Hz

9.4. CEM and safety

9.4.1. Electromagnetic compatibility

The instruments are compliant with the standards and any amendments, in their industrial classification:

↪ IEC 61326-1 with a quantity of influence in the presence of a magnetic field of 10V/m

9.4.2. Electrical safety

↪ IEC 61010-1 (2010 + amendment 1)

↪ IEC 61000-2-030 (2017)

Electrical safety without accessories	600V CAT III, double isolation
Max. input voltage without accessories	300 VDC, 300 Vrms, 414 Vpk (DC + peak AC at 1kHz)

Derating values

a) Electrical safety:

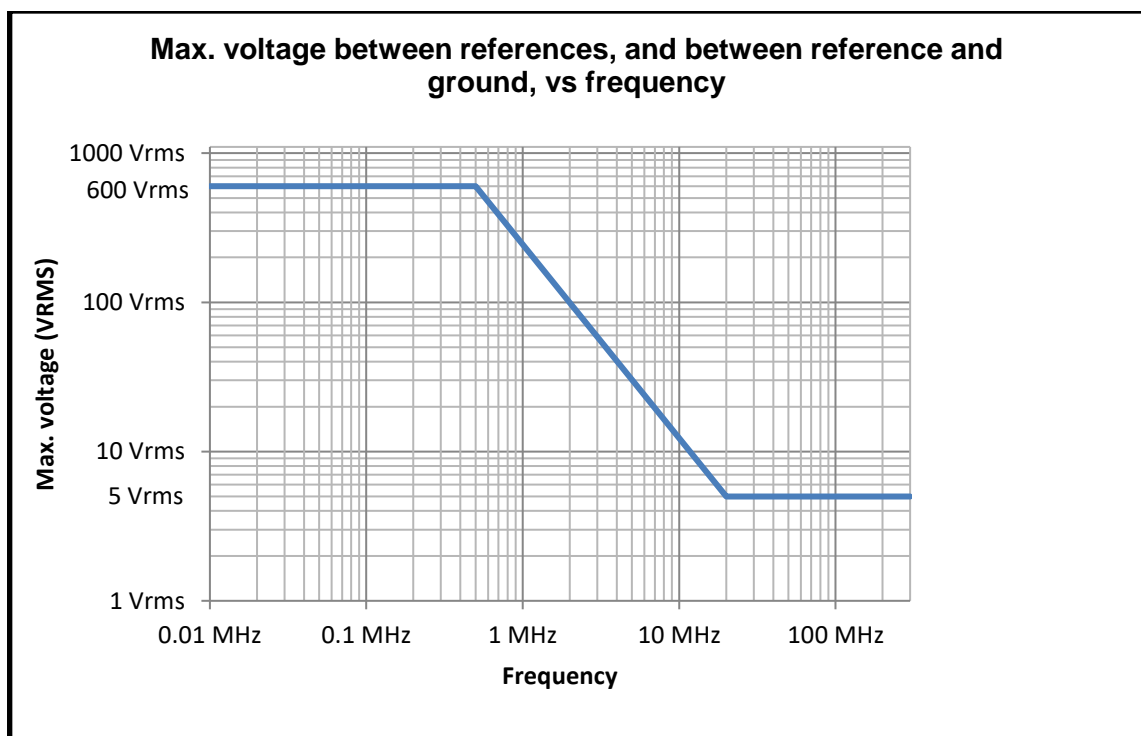

b) Input voltage:

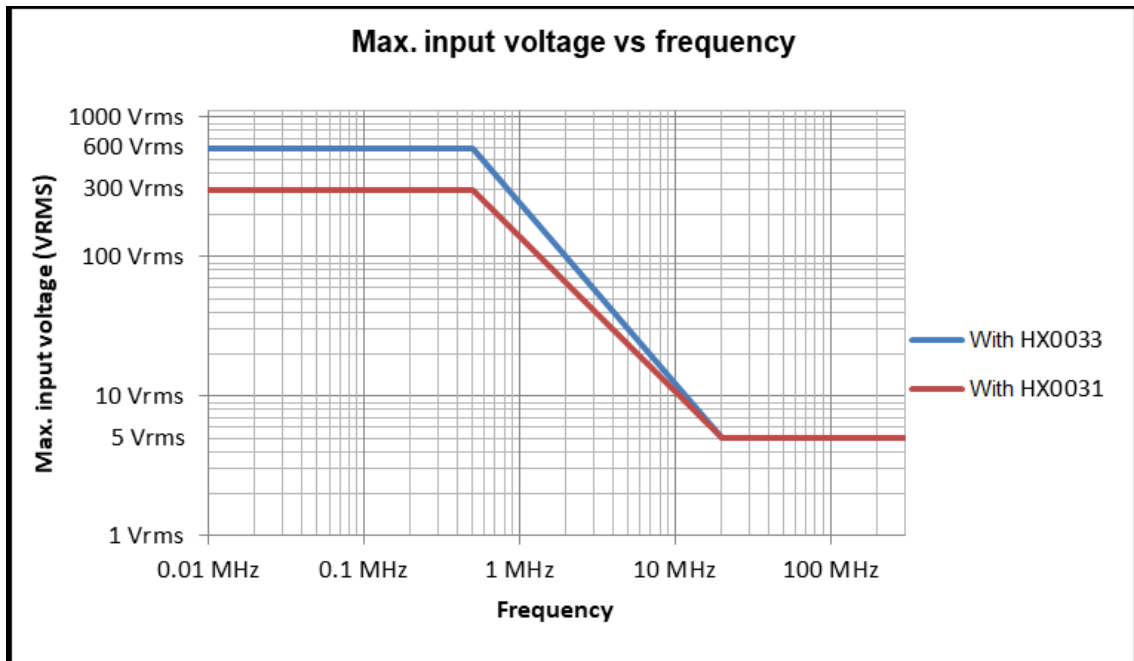
**9.4.3. Temperature**

Maximum internal temperature: 185°F (85°C) when the max. ambient temperature is 104°F (40°C).

10. MAINTENANCE

10.1. Warranty



This oscilloscope is guaranteed for three (3) years against defects of materials or workmanship, in accordance with the general terms of sale.

During this period, the instrument must be repaired only by the manufacturer, which reserves the right either to repair the instrument or to replace all or part of it. If the equipment is sent back to the manufacturer, the customer pays for shipping to the manufacturer.

The **warranty** does not apply in the following cases:

- Inappropriate use of the equipment or use with incompatible equipment
- Modifications made to the equipment without the explicit permission of the manufacturer's technical staff
- Work done on the device by a person not approved by the manufacturer
- Adaptation to a particular application not anticipated in the definition of the equipment or not indicated in the user's manual
- Damage caused by shocks, falls, or floods

10.2. Cleaning



- Power down the instrument.
- Clean it with a damp cloth and soap.
- Never use abrasive substances, solvents, alcohol, or hydrocarbons.
- Let dry before using again.

10.3. Repair and metrological verification

See attached safety data sheet.

Warning!

In all cases, if you find a defect (broken screen, broken Probix socket, defective housing, etc.) do not use your ScopiX, because its insulation may be impaired. Return it immediately to customer service for repair.



USA

Chauvin Arnoux Group d.b.a AEMC

15 Faraday Drive
Dover, NH 03820 USA

Phone: (800) 945-2362 (Ext. 360)
(603) 749-6434 (Ext. 360)

Fax: (603) 742-2346 or (603) 749-6309

E-mail: repair@aemc.com

INTERNATIONAL

Chauvin Arnoux Group

Phone: +33 1 44 85 44 38
Fax: +33 1 46 27 95 69

Our international contacts

www.chauvin-arnoux.com/contacts

