

# Handscope Harmonic Analyzer Oscilloscopes

## OX 5022B - 20 MHz

## OX 5042B - 40 MHz

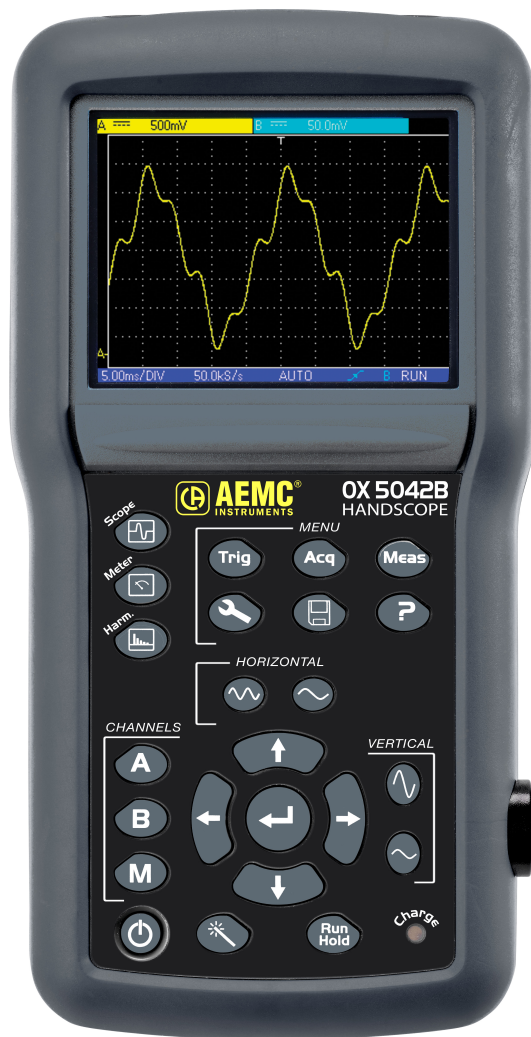

**PORTABLE OSCILLOSCOPES**

*Measure Up*  
WITH AEMC® INSTRUMENTS



Thank you for purchasing this portable digital oscilloscope with channels isolated from each other and from earth.

To obtain the best service from your instrument:

- **Read** these user manual carefully,
- **Comply with** the precautions for use.

<b>OX 5022B</b>	color screen	2 channels	20 MHz	scale 50 MS/s
<b>OX 5042B</b>	color screen	2 channels	40 MHz	scale 50 MS/s

 WARNING, risk of DANGER! The operator must refer to these instructions whenever this danger symbol appears.

 WARNING, risk of electric shock. The voltage applied to parts marked with this symbol may be hazardous.

 Useful information or tip.

 Double insulation.

 Chauvin Arnoux has adopted an Eco-Design approach in order to design this appliance. Analysis of the complete lifecycle has enabled us to control and optimize the effects of the product on the environment. In particular this appliance exceeds regulation requirements with respect to recycling and reuse.

 The CE marking indicates conformity with European LVD and EMC directives.

 The rubbish bin with a line through it means that in the European Union, the product must undergo selective disposal in compliance with Directive WEEE 2012/19/EU.

### Definition of Measurement Categories

- Measurement category IV corresponds to measurements taken at the source of low-voltage installations.  
Example: power feeders, counters and protection devices.
- Measurement category III corresponds to measurements on building installations.  
Example: distribution panel, circuit-breakers, machines or fixed industrial devices.
- Measurement category II corresponds to measurements taken on circuits directly connected to low-voltage installations.  
Example: power supply to electro-domestic devices and portable tools.

## PRECAUTIONS FOR USE

This instrument is compliant with safety standard IEC 61010-2-034, the leads are compliant with IEC 61010-031, and the current sensors are compliant with IEC 61010-2-032, for voltages up to 600 V in category III. Do not use the instrument for measurements on circuits that are not in measurement categories II, III, or IV or that might be connected inadvertently to circuits that are not in measurement categories II, III, or IV.

- The operator and/or the responsible authority must carefully read and clearly understand the various precautions to be taken in use. Sound knowledge and a keen awareness of electrical hazards are essential when using this instrument.
- If you use this instrument other than as specified, the protection it provides may be compromised, thereby endangering you.
- Do not use the instrument on networks of which the voltage or category exceeds those mentioned.
- Do not use the instrument if it seems to be damaged, incomplete, or poorly closed.
- Before each use, check the condition of the insulation on the leads, housing, and accessories. Any item of which the insulation is deteriorated (even partially) must be set aside for repair or scrapping.
- Before using your instrument, check that it is perfectly dry. If it is wet, it must be thoroughly dried before it can be connected or used.
- Use only the leads and accessories supplied. The use of leads (or accessories) of a lower voltage or category limits the voltage or category of the combined instrument and leads (or accessories) to that of the leads (or accessories).
- Use personal protection equipment systematically.
- When handling the leads, test probes, and crocodile clips, keep your fingers behind the physical guard.
- Any troubleshooting or metrological verification procedure must be carried out by accredited skilled personnel.

# CONTENTS

<b>1. FIRST START-UP</b> .....	<b>6</b>
1.1. Unpacking.....	6
1.2. Accessories.....	6
<b>2. DESCRIPTION OF THE INSTRUMENT</b> .....	<b>7</b>
2.1. Presentation.....	7
2.2. Power supply.....	7
2.3. Batteries.....	7
2.4. Channel insulation.....	8
2.5. OX 5022B & OX 5042B.....	9
2.6. Advice for use of the sensors.....	10
2.7. Sensor calibration.....	11
2.8. Front panel description.....	13
<b>3. OSCILLOSCOPE MODE "THE KEYS"</b> .....	<b>14</b>
3.1. "Menu" key.....	14
3.2. 3 Channel A, B and Math or Memory keys.....	14
3.3. 2 "Time base" keys.....	15
3.4. 2 "Sensitivity" keys.....	15
3.5. 2 Functional keys.....	15
<b>4. OSCILLOSCOPE MODE "DISPLAY"</b> .....	<b>16</b>
4.1. Display.....	16
4.2. Channel data.....	16
4.3. Main display.....	18
4.4. Time data.....	18
<b>5. OSCILLOSCOPE MODE "THE MENUS"</b> .....	<b>19</b>
5.1. Display.....	19
5.2. Organization.....	19
5.3. Main menu area.....	19
5.4. Secondary menu area.....	19
5.5. Navigation.....	20
<b>6. OSCILLOSCOPE MODE - THE CHANNEL "A" OR "B" MENU</b> .....	<b>22</b>
6.1. The channel "A" or "B" menu.....	22
<b>7. OSCILLOSCOPE MODE "THE MATH CHANNEL MENU"</b> .....	<b>26</b>
7.1. The "M Channel" menu.....	26
<b>8. OSCILLOSCOPE MODE "THE TRIGGER MENU"</b> .....	<b>30</b>
8.1. The "Trigger" menu.....	30
8.2. Description.....	31
8.3. Examples.....	32
<b>9. OSCILLOSCOPE MODE "THE ACQUISITION MENU"</b> .....	<b>35</b>
9.1. The "Acquisition" menu.....	35
9.2. Examples.....	36
<b>10. OSCILLOSCOPE MODE "THE MEASUREMENT MENU"</b> .....	<b>39</b>
10.1. The "Measurement" menu.....	39
<b>11. OSCILLOSCOPE MODE "THE MEMORY MENU"</b> .....	<b>42</b>
11.1. The "MEMORY" menu.....	42
11.2. Example.....	43
11.3. Description.....	44
<b>12. OSCILLOSCOPE MODE "THE TOOLS MENU"</b> .....	<b>45</b>
12.1. The "TOOLS" menu.....	45
<b>13. OSCILLOSCOPE MODE "THE HELP KEY"</b> .....	<b>46</b>
13.1. The "HELP" key.....	46
<b>14. MULTIMETER MODE "THE KEYS"</b> .....	<b>47</b>
14.1. 6 "Menu" keys.....	47
14.2. 3 keys : Channel A, B and Math.....	47
14.3. "Time base" keys.....	48
14.4. 2 "SENSITIVITY" keys.....	48
14.5. Functional keys.....	48
<b>15. MULTIMETER MODE "DISPLAY"</b> .....	<b>49</b>
15.1. DISPLAY.....	49
15.2. Measurement zone.....	49
15.3. Graphic window area.....	50
15.4. Main menu area.....	50
15.5. Secondary menu area.....	50

<b>16. MULTIMETER MODE "THE MEASUREMENT MENU" .....</b>	<b>51</b>
16.1. The "MEASUREMENT" menu.....	51
16.2. Description.....	51
<b>17. MULTIMETER MODE "THE CHANNEL A OR B MENU" .....</b>	<b>54</b>
17.1. The channel "A" or "B" menu.....	54
17.2. Notes .....	54
17.3. Example : Multimeter coupling .....	55
<b>18. MULTIMETER MODE "THE MEMORY MENU" .....</b>	<b>56</b>
18.1. The "MEMORY" menu.....	56
<b>19. HARMONIC ANALYSER MODE "THE KEYS" .....</b>	<b>57</b>
19.1. "Menu" keys.....	57
19.2. 3 keys channel "A" + "B" and Math.....	57
19.3. 2 "TIME BASE" keys .....	58
19.4. 2 "SENSITIVITY" keys.....	58
19.5. 2 functional keys.....	58
<b>20. HARMONIC ANALYSER MODE "DISPLAY" .....</b>	<b>59</b>
20.1. Display.....	59
20.2. Measurement zone.....	59
20.3. Harmonic display area.....	60
20.4. Harmonic reference area.....	60
20.5. Main and secondary menu zones.....	60
<b>21. HARMONIC ANALYSER MODE "THE CHANNEL A OR B MENU" .....</b>	<b>61</b>
21.1. The Channel "A" or "B" menu.....	61
<b>22. HARMONIC ANALYSER MODE "ACQUISITION MENU" .....</b>	<b>62</b>
22.1. The "Acquisition" menu.....	62
<b>23. HARMONIC ANALYSER MODE "MEMORY MENU" .....</b>	<b>63</b>
23.1. The "MEMORY" menu.....	63
<b>24. REMOTE PROGRAMMING.....</b>	<b>64</b>
24.1. Presentation .....	64
24.2. Connecting the oscilloscope.....	64
24.3. Updating .....	64
<b>25. TECHNICAL SPECIFICATIONS "OSCILLOSCOPE MODE" .....</b>	<b>65</b>
25.1. Vertical deflection .....	65
25.2. Horizontal deflection (time base).....	66
25.3. Trigger circuit.....	66
25.4. Acquisition chain.....	67
25.5. Formats of the different files .....	67
25.6. Measurement processing .....	68
25.7. Display.....	69
<b>26. TECHNICAL SPECIFICATIONS "ACCESSORIES" .....</b>	<b>70</b>
<b>27. TECHNICAL SPECIFICATIONS "MULTIMETER MODE" .....</b>	<b>71</b>
<b>28. NETWORK "HARMONIC ANALYSIS MODE " .....</b>	<b>73</b>
<b>29. COMMUNICATION INTERFACES.....</b>	<b>73</b>
29.1. USB/OPTICAL interface .....	73
<b>30. GENERAL SPECIFICATIONS .....</b>	<b>74</b>
30.1. Environment .....	74
30.2. Power supply.....	74
30.3.  .....	74
<b>31. MECHANICAL SPECIFICATIONS .....</b>	<b>75</b>
31.1. Box .....	75
31.2. Packaging.....	75
<b>32. SUPPLY.....</b>	<b>75</b>
32.1. Accessories .....	75
<b>33. MAINTENANCE.....</b>	<b>76</b>
33.1. Cleaning .....	76
33.2. Updating the internal software of the instrument.....	76
<b>34. WARRANTY.....</b>	<b>76</b>
<b>35. REMOTE PROGRAMMING MANUAL.....</b>	<b>77</b>
35.1. Presentation .....	77
35.2. Connection of the instrument.....	77
35.3. Programming convention.....	77



# 1. FIRST START-UP

## 1.1. UNPACKING



**OX 5042B Only**

		OX 5022B	OX 5042B
<b>00</b>	6 NiMH 1.2 V Rechargeable Batteries	✓	✓
<b>1</b>	One Portable Oscilloscope	✓	✓
<b>2</b>	BNC-Banana Adapter	✓ <b>x2</b>	✓ <b>x1</b>
<b>3</b>	Set of PVC Straight-Straight Banana Leads (1.5 m, red and black)	✓ <b>x2*</b>	–
	Set of Straight-Straight Banana Leads (3 m, red and black)	–	✓ <b>x1</b>
<b>4</b>	Set of Alligator Clips (red and black)	✓ <b>x2</b>	✓ <b>x1</b>
<b>5</b>	Set of 1000 V CAT-IV Test Probes (red and black)	✓ <b>x2</b>	✓ <b>x1</b>
<b>6</b>	Probe 10:1 600 V/BNC M	✓ <b>x1</b>	✓ <b>x2</b>
<b>7</b>	Cable - Replacement USB Charging Cable	✓	✓
<b>8</b>	USB Wall Plug 5 V, 2 A**	✓	✓
<b>9</b>	USB Cable + Driver	✓	✓
<b>10</b>	Metrix Carrying Pouch	✓	–
<b>11</b>	Quick Start Guide (QSG)	✓	✓
<b>12</b>	Safety Data Sheet	✓	✓
<b>13</b>	NiMH Battery Connector	✓	✓
<b>14</b>	Test Report AEMC	✓	✓
	Packaging Box	✓	✓

\*Leads for OX 5022B are a different color than shown (black-gray, red-gray)

\*\*Replacement 5 V, 2 A USB power adapters are commercially available.

## 1.2. ACCESSORIES

Order Accessories and Replacement Parts Directly Online  
Check our Storefront at [www.aemc.com/store](http://www.aemc.com/store)

## 2. DESCRIPTION OF THE INSTRUMENT

### 2.1. PRESENTATION

The particularity of these oscilloscopes is that they group 3 instruments in one:

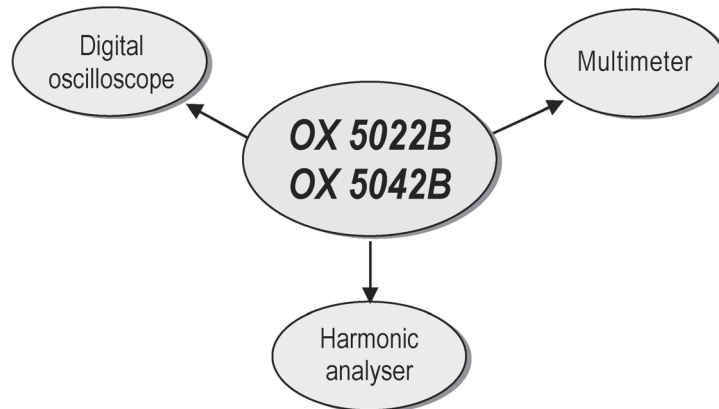

- a laboratory digital oscilloscope for the analysis of electronic and electrotechnical signals,
- a 2-channel, 8000-count multimeter,
- a harmonic analyser, for the simultaneous decomposition of 2 signals with their fundamental and their first 31 harmonics.

The instrument operates at a constant acquisition depth of 2,500 points.  
An LCD TFT screen is used to view the applied signals along with all the setting parameters.  
The main command functions are accessible using the keys on the front panel.

A graphic interface is used to:

- adjust the parameters related to the selected button,
- navigate using a horizontal main menu showing the current settings and vertical sub-menus.

### 2.2. POWER SUPPLY

The oscilloscope is delivered with:

- one mains to USB supply and one jack to USB cord with a ferrite  
Voltage: 5 VDC  
Power: 2 A

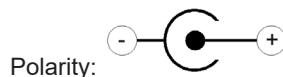

- 6 rechargeable → NiMH (1.2 V - LR6 or AA) accumulator batteries.

When the external power supply is connected, this power source is preferred for the instrument's operation. Thus the accumulators are only used when there is no external power supply.



**With the external power supply you can use your oscilloscope even if the batteries are flat, defective or even absent.**

### 2.3. BATTERIES



A "battery empty" indicator appears on the screen when the accumulator-battery charge level is insufficient and a new power source is needed quickly:

- connect the external power supply or
- change the batteries.

If the external power supplied is not connected when the level becomes critical, an alarm message "Battery level is critical, the appliance is about to power off" precedes the automatic shutdown of the instrument.

### 2.3.1. CHARGE

The batteries are charged when the oscilloscope is powered off but connected to the external power supply. During the fast charge of the batteries, the front-panel LED is on.

It flashes in the following situations:

- pre-charge of very flat batteries
- temperature too low or too high
- batteries damaged.

The batteries must be replaced with rechargeable Ni-MH batteries. The life between charges will be the same as with the batteries supplied with the oscilloscope if the replacement batteries have the same capacity (indicated in A·h).

The LED goes off when charging is complete.

If charging is interrupted before it is complete, the LED remains on for one minute to remind the user that the batteries are not fully charged.



**It is possible, but not recommended, to use standard alkaline batteries (AA type) to replace the accumulators, but in this case be careful:**

- not to connect the external power supply because when the instrument is switched off the charge mechanism is activated which can lead to destruction of the batteries and damage to the instrument;
- not to leave the batteries in the instrument for too long to avoid any problems caused by leakage from the batteries.

### 2.3.2. ACCESS

If necessary, the batteries(1) are accessible from the rear panel of the oscilloscope after turning the "quarter turn" (2) lock anti-clockwise; use a coin (3):

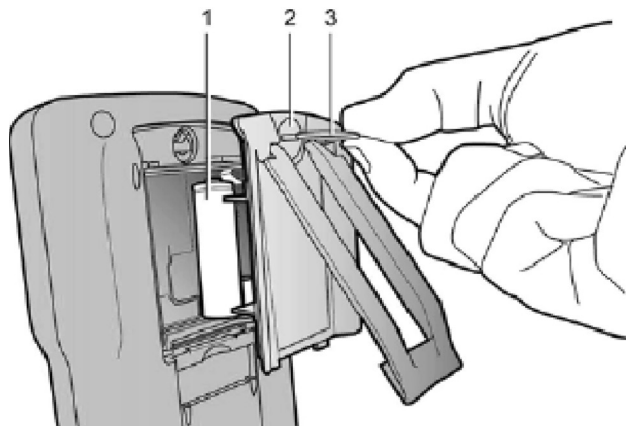

## 2.4. CHANNEL INSULATION



The two oscilloscope input channels are insulated from each other and from the earth and the mains power supply block. This insulation is double or reinforced in compliance with the safety standards IEC 61010-1 and IEC 61010-2-030.

This makes it possible to make measurements on installations or systems connected to the electricity supply network for voltages of up to 600 V in CAT III. The common mode authorised between the two channels is 600 V in CAT III.

Thus the operator, the test systems and the environment are completely protected at all times.

Any voltage (even dangerous) on one channel will not be present on the other channel. The low points of the inputs are completely insulated, so there is no possibility of the low points looping (which can be dangerous and highly destructive).

The oscilloscope insulation is as shown in the diagram below:

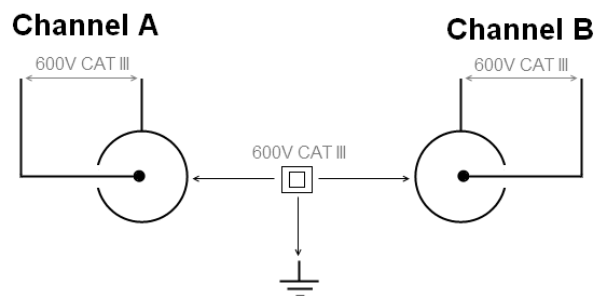





The use of accessories with a voltage and/or category lower than 600 V CAT III reduces the operating range to the lower voltages and/or categories.  
Your oscilloscope is rated 600 V CAT III; at least 600 V CAT III accessories must be used. The accessories shipped with the instrument allow this.

## 2.5. OX 5022B & OX 5042B

### 2.5.1. FRONT PANEL

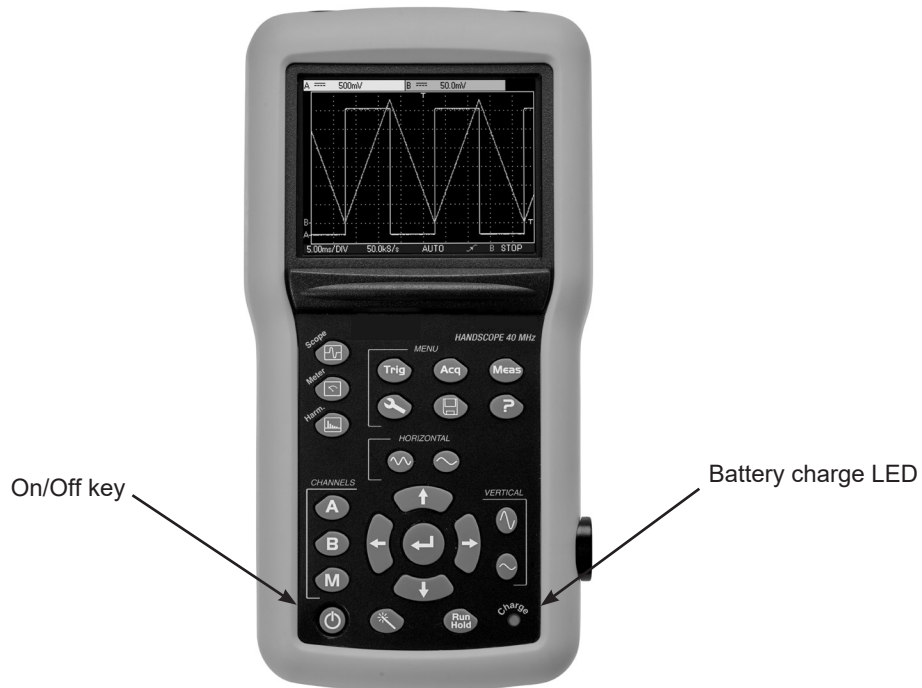

### 2.5.2. BACK FACE

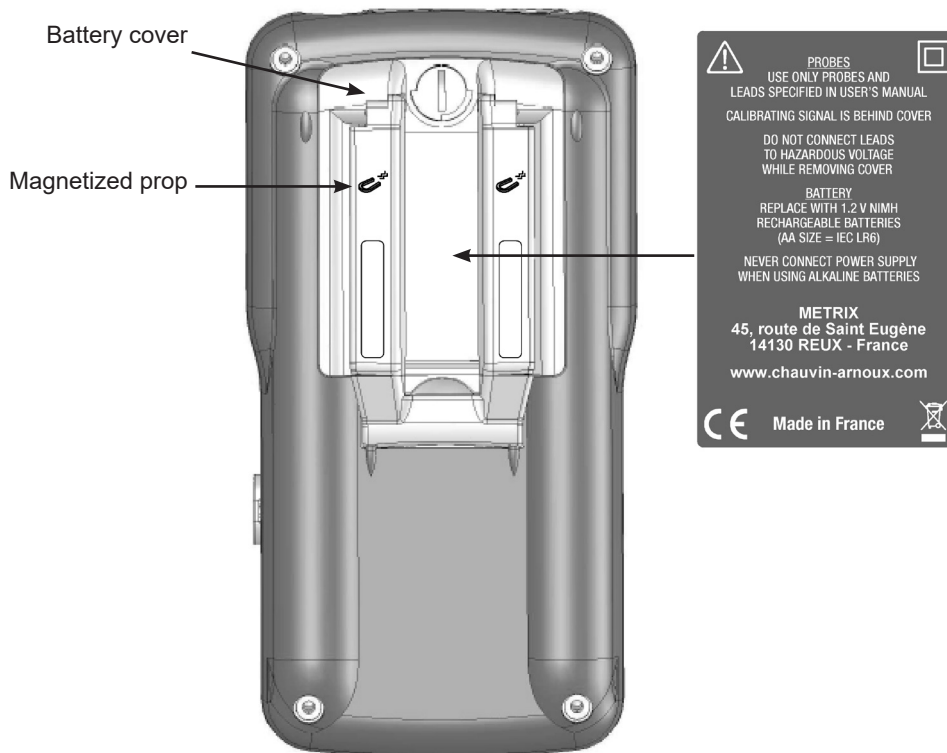

The retractable prop can hold the instrument in position at 30 ° from the horizontal.

### 2.5.3. MEASUREMENT TERMINAL

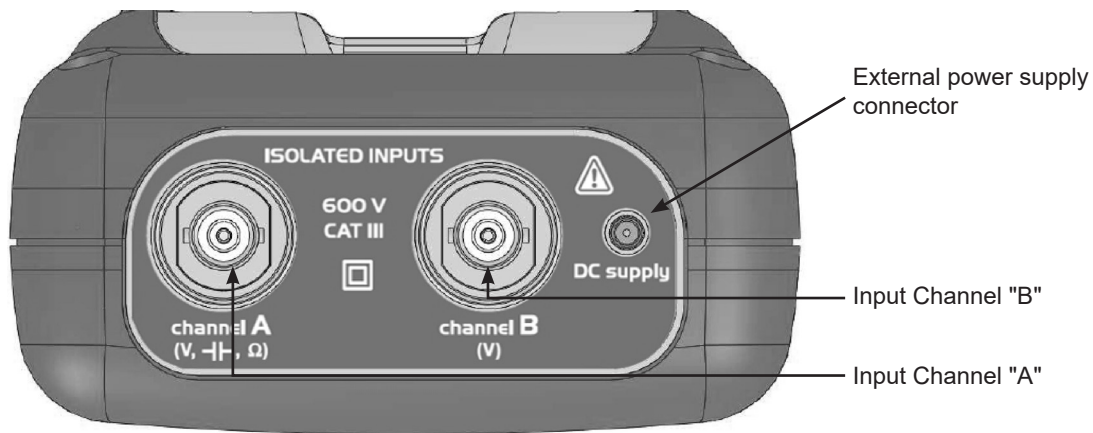

### 2.5.4. SIDE

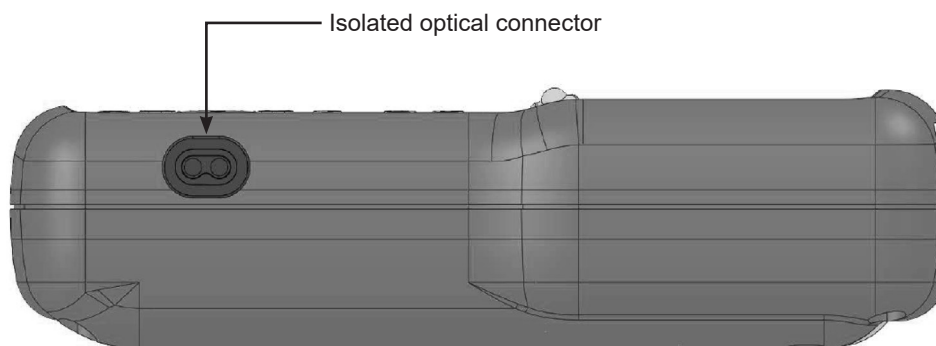

## 2.6. ADVICE FOR USE OF THE SENSORS

### 2.6.1. CONNECTION OF THE REFERENCE CONDUCTORS TO THE SENSOR

Distribution of stray capacitors:

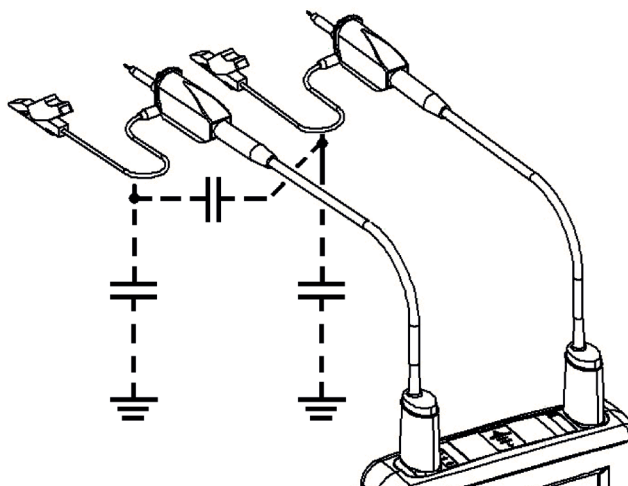

It is imperative, considering the stray capacitances, to correctly connect the reference conductors for each sensor. The conductors should preferably be connected to the cold points to avoid the transmission of noise by the stray capacitance between modes.

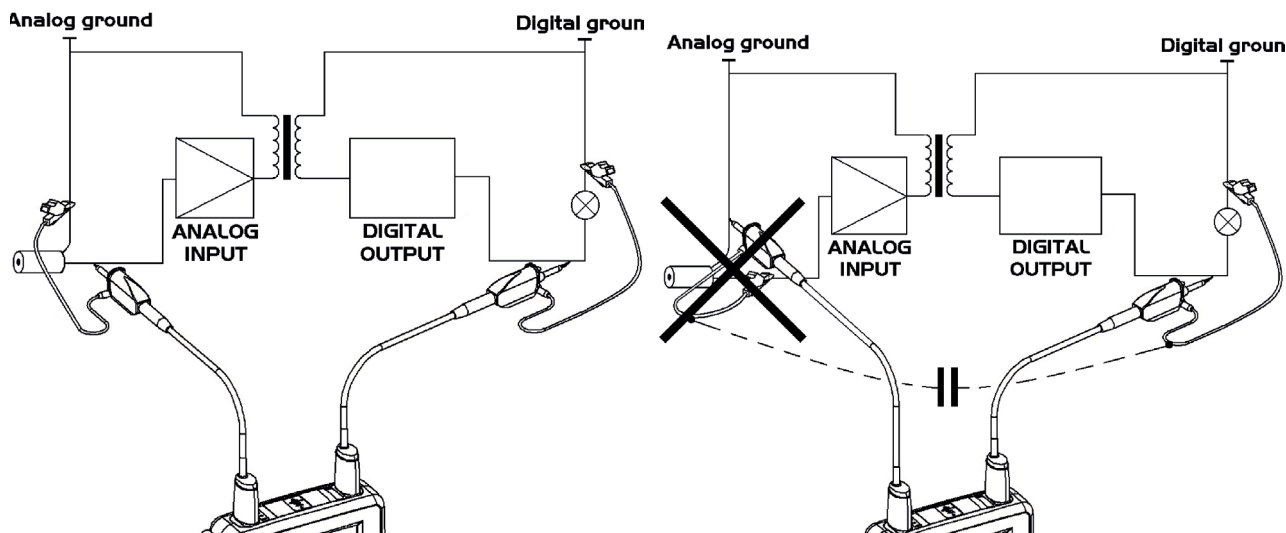

The noise of the digital ground (earth) is sent to the analogue input by the stray capacitance.



**Reminder: In order to prevent electric shocks or possible fires:**

**Never use accessories on which the casing is accessible if it has a voltage of > 30 Vrms compared to the earth.**

**This precaution is necessary for example for sensors with an accessible metal BNC. The accessories shipped with the instrument are compliant.**



**Reminder: Definitions of the symbols and precautions of use per the IEC 61010-2-032 standard, max. voltage 600 V in Category III (with respect to earth and between the two channels).**

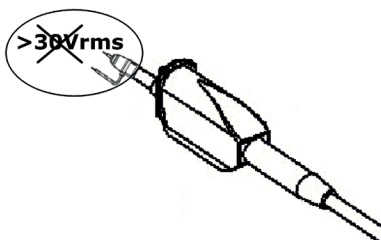

## 2.7. SENSOR CALIBRATION

The calibration output (3 Vpp, 1 kHz) for the sensors is underneath the battery cover (see § 2.5.2. Back face).

To obtain optimum response, the sensor's low frequency compensation must be adjusted. To carry out this adjustment, the two channels of your oscilloscope must be disconnected from the measured circuits before opening the battery housing cover.



**Connect the sensor to be adjusted to the calibration output under the battery housing cover, as shown opposite.**



Select the DC coupling for the channel to which the sensor is connected and run an autose (icon opposite) to carry out pre-setting. Adjust the sensitivity and the vertical offset of the channel so that the signal fills the screen, and adjust the time base to 200  $\mu$ s to view a signal period on the screen. Turn the BNC base of the sensor in order to access the sensor adjustment screw:

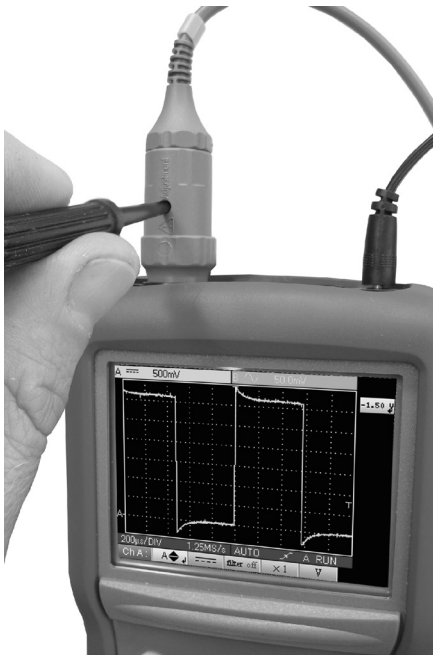

In the example opposite the sensor is over-compensated: an overshoot occurs.

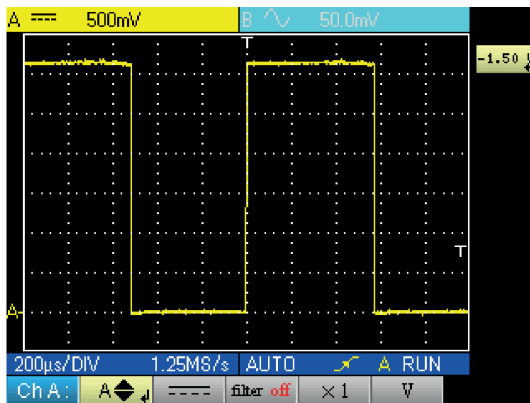

Turn the screw in either direction until the signal is horizontal and looks like the screen shown opposite. Your sensor is now calibrated, so you can turn the BNC base again to close access to the adjustment screw.



Replace the battery cover in order to use your instrument in optimum safety conditions.

## 2.8. FRONT PANEL DESCRIPTION

The main functions of the instrument are accessed from the front panel.

### 2.8.1. ON / OFF KEY



The instrument is switched on by a short press on the key shown opposite. It is switched off by a long press (a shutdown message appears and a beep sounds).

### 2.8.2. OPERATING MODE KEYS

Pressing one of these three keys selects the instrument's operating modes without changing the measurement input connections:



- oscilloscope



- multimeter



- harmonic analyser

### 2.8.3. NAVIGATION KEYS

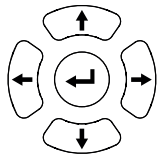

This block of keys is used to move around the menus and in the dialogue boxes; it is also used to move graphic objects (cursor, trigger, memory position...) through the menus.

#### ■ Action of the horizontal keys:

- Horizontal movement through the main menus
- Adjustment of values in the secondary menus
- Horizontal movement in a dialogue box

#### ■ Action of the vertical keys:

- Vertical movement and automatic selection in the secondary menus
- Adjustment of values in the main menus
- Vertical movement in a dialogue box

#### ■ Action of the central "Enter" key:

- Opens a dialogue window from a main menu or a secondary menu
- Validation of the items in a dialogue window

## 3. OSCILLOSCOPE MODE "THE KEYS"



Pressing this key selects the "Oscilloscope" mode.

### 3.1. "MENU" KEY

Trigger



displays the main "Trigger" menu

Acquisition



displays the main "Acquisition" menu

Tools



displays the main "Tools" menu

Measurement



displays the main "Measurement/Cursor" menu

Memory



displays the main "Memory" menu

Help



displays the "Help" window

### 3.2. 3 CHANNEL A, B AND MATH OR MEMORY KEYS

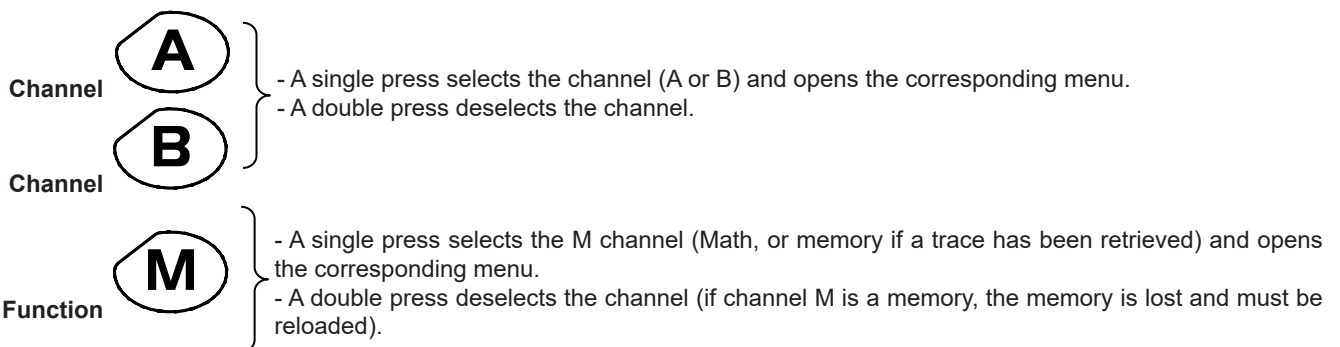

If references are present (§ 11.1), deselecting the channel permanently erases the associated reference.

### 3.3. 2 "TIME BASE" KEYS



increases the time base for acquisition up to 200 s.



decreases the time base for acquisition down to 25 ns.

### 3.4. 2 "SENSITIVITY" KEYS



increases the vertical sensitivity of the last channel selected, up to 5 mV.



decreases the vertical sensitivity of the last channel selected, down to 200 V.



For the M channel, the "sensitivity" key varies the amplitude factor but only if a math channel is validated.

### 3.5. 2 FUNCTIONAL KEYS



performs an automatic adjustment on channels A and B. The success of each vertical autosest conditions the activation of the channel.



starts or stops acquisition.

# 4. OSCILLOSCOPE MODE "DISPLAY"

## 4.1. DISPLAY

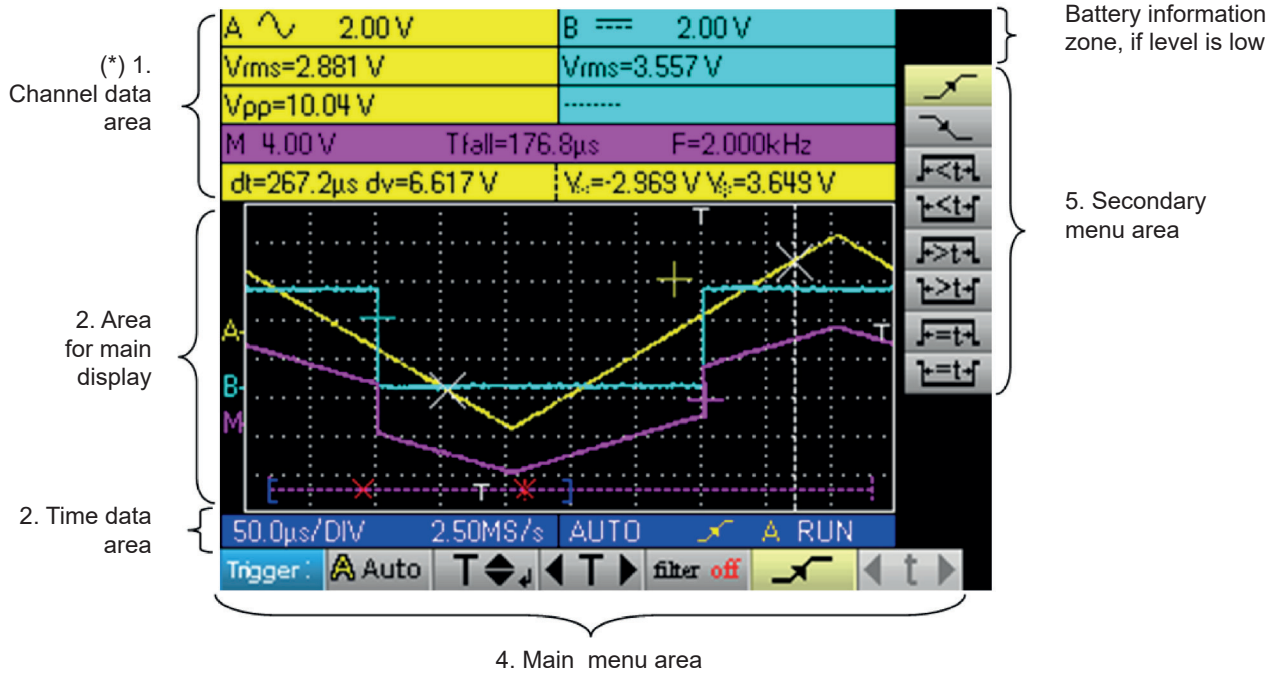

## 4.2. CHANNEL DATA

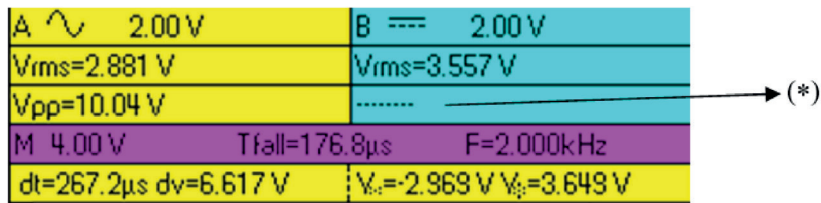

### 4.2.1. "MAIN CHANNEL" AREA

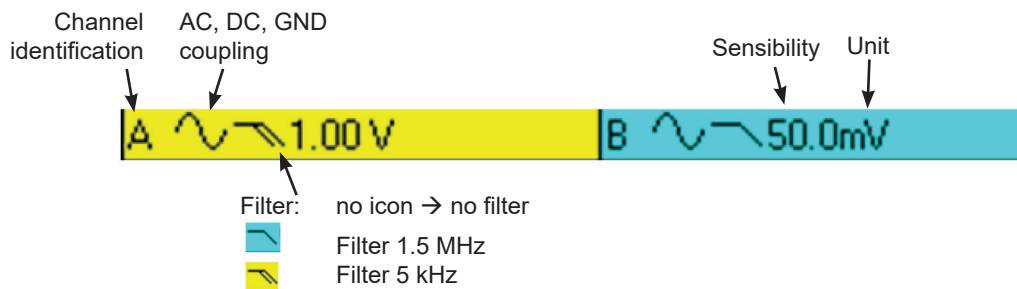

The direct data from channels A and B are displayed in this window:

- Channel identification
- Channel coupling
- Filter
- Channel sensitivity
- Channel unit

(\*) If no measurement is selected, if measurement is impossible or if the channel is not validated, the measurement will be replaced by dashes.



#### 4.2.2. "AUTOMATIC MEASUREMENT" AREA

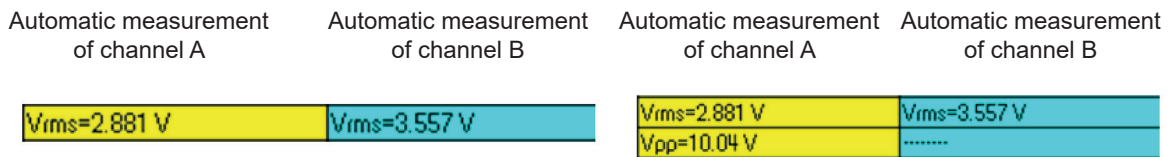

The selected automatic measurements are shown in this window. 1 or 2 measurements per channel can be selected.

#### 4.2.3. "MATH" AREA

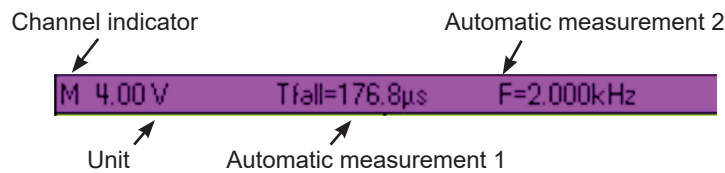

Violet background in "M" channel shows a Math function

#### 4.2.4. "MEMORY" AREA



Green background if "M" channel shows a Memory function

The "M" channel data is shown in this window. This channel can contain a "Math" or a "Memory" function.

In the "M" channel shows a "Math" function, the following data is shown:

- Channel identification
- Sensitivity
- Unit
- Automatic measurements

If the "M" channel shows a "Memory" function, the following data is shown:

- Channel identification
- Sensitivity
- Coupling
- Filter
- Unit
- Automatic measurements

#### 4.2.5. "CURSOR MEASUREMENT" ZONE

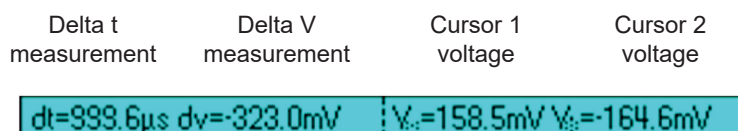

The measurements by cursor are shown in this window. The background colour is identical to that for the channel to which the cursors are attached.

It indicates:

- the horizontal difference (dt) and vertical difference (dv) between the 2 cursors,
- the voltage measurement of the cursors.

### 4.3. MAIN DISPLAY

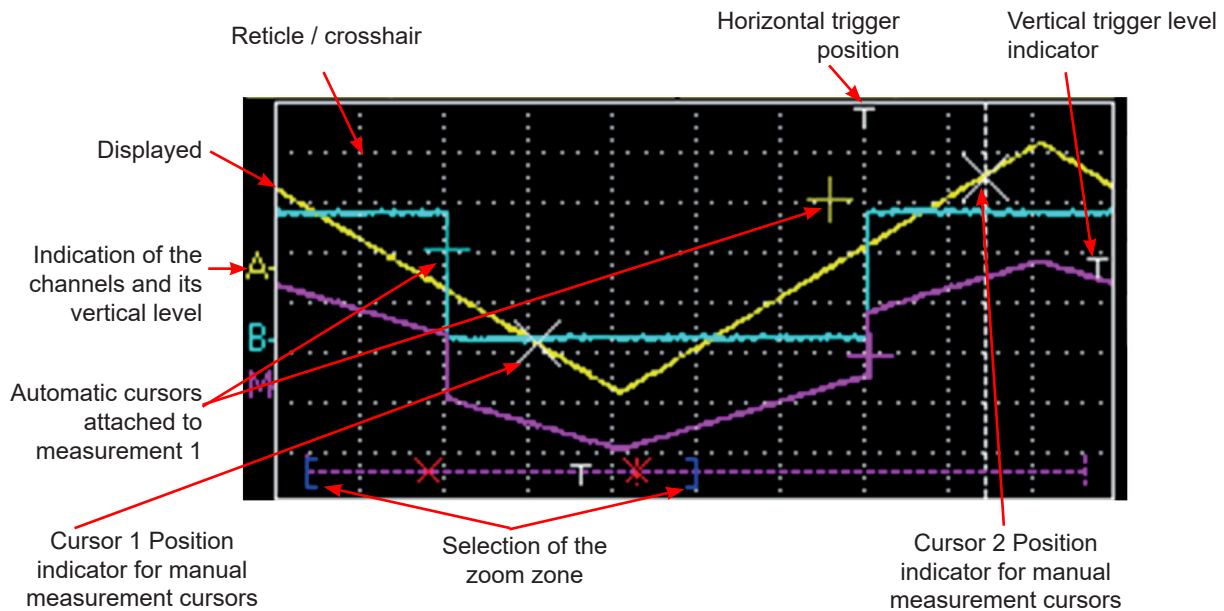

### 4.4. TIME DATA

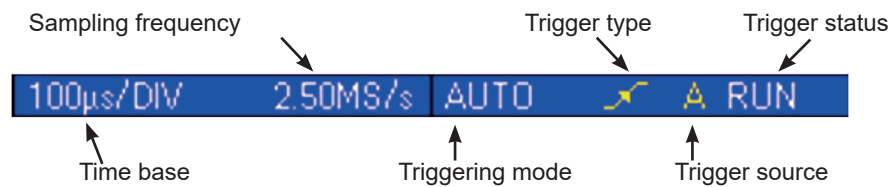

This window is split into two groups:

- A time data group
  - time base
  - sampling frequency
- A trigger data group:
  - triggering mode
  - trigger type
  - trigger source
  - trigger status: RUN, READY, STOP.

# 5. OSCILLOSCOPE MODE "THE MENUS"

## 5.1. DISPLAY

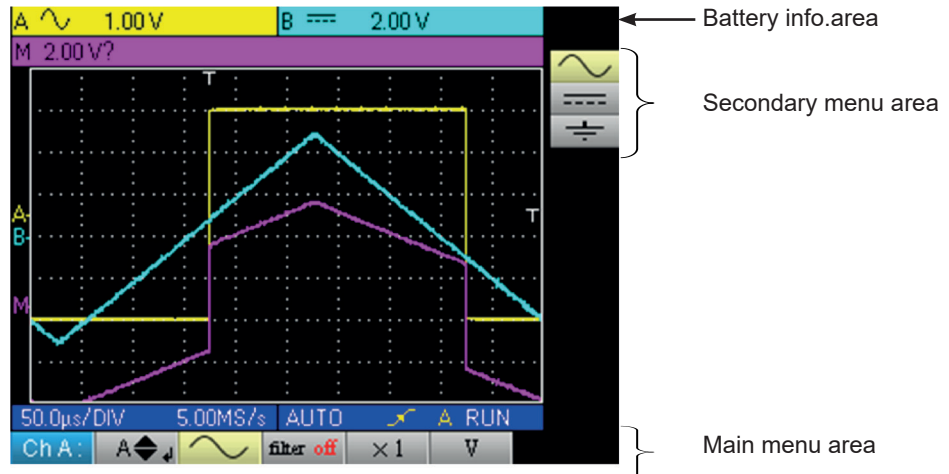

## 5.2. ORGANIZATION

The menus have two elements:

- a horizontal menu, called "main", located at the bottom of the screen;
- a vertical menu, called "secondary" located to the right of the screen.

### 5.2.1. MAIN MENU

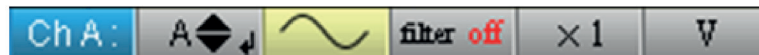

When a tab is selected in the menus, its background turns yellow. When a setting is not available in the current mode, it is greyed out in the main menu and cannot be selected.

### 5.2.2. SECONDARY MENU



Each tab of the main menu is associated with a secondary menu used to view the different possible settings for the parameter in question.

The two menus automatically disappear and full screen mode is activated after about twenty seconds with no action on the keypad. Pressing the button of the menu displays it again.

## 5.3. MAIN MENU AREA

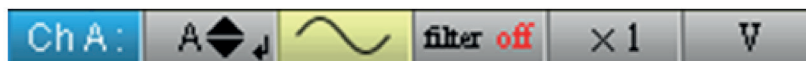

Main menu: displays the oscilloscope configuration

## 5.4. SECONDARY MENU AREA



Secondary menu: gives access to various parameter settings selected from the main menu.

## 5.5. NAVIGATION

### 5.5.1. CLASSICAL NAVIGATION

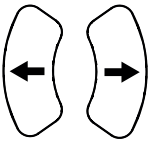

These keys are used to navigate in the main menu.



These keys are used to:



- navigate in the secondary menu,
- set a vertical parameter (see § Vertical settings)



### 5.5.2. VERTICAL SETTINGS

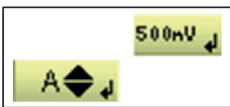

Vertical settings are recognized by the double arrows  on the main menu tab.





■ To change the value:

- the   keys are used to change the numeric value displayed in the secondary menu and therefore move the graphic object linked to the settings in the direction of the arrows.

- the  key opens the data entry window for direct value entry (see § Activation a dialogue window).

■ To quit the setting:

- The   keys can always be used to navigate the main menu and therefore quit the setting.



### 5.5.3. HORIZONTAL SETTINGS



The horizontal settings are recognized by the two arrows that  frame the parameter identification on the main menu tab.





- To change the value: using the   keys, select the numeric value tab from the secondary menu.

- the   arrows are used to change the value and therefore move the linked graphic object in the direction of the arrows;

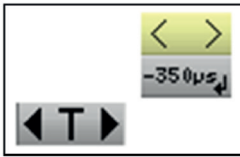
- the  key is used to open the direct value entry window (see § Activating a dialogue window).

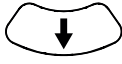

■ To quit the setting:

- using the   keys, select the quit tab  from the secondary menu.

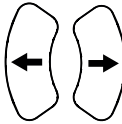
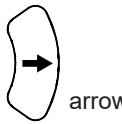
- the   arrows can then be used to navigate the main menu.

#### 5.5.4. ACTIVATING A DIALOGUE WINDOW

The settings that can be adjusted using a dialogue window can be recognized from the  symbol on the menu tab.

When the tab is selected, pressing the  key opens a dialogue window.



#### Direct settings entry window

This window is used to directly adjust the numeric value of the parameter in question.

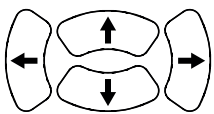
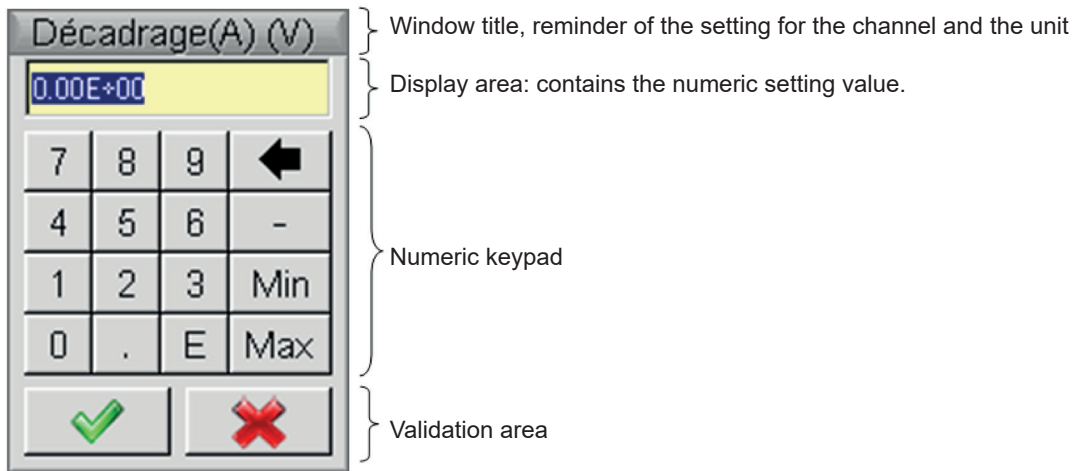

Navigation in the active element window (yellow highlighting).



Validation of the activated key or, in the display area, "Inout / Output" for the selection mode.



The selection mode is used to select several characters from the display area (blue highlighting) using

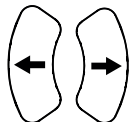

the keys:

The selected characters can be replaced in this way by the value of the button which is validated on the numeric keypad (or deleted using the  button).

When the window opens, the current variable value is completely selected by default.

# 6. OSCILLOSCOPE MODE - THE CHANNEL "A" OR "B" MENU

## 6.1. THE CHANNEL "A" OR "B" MENU

**A**

**B**

Press one of these two keys.

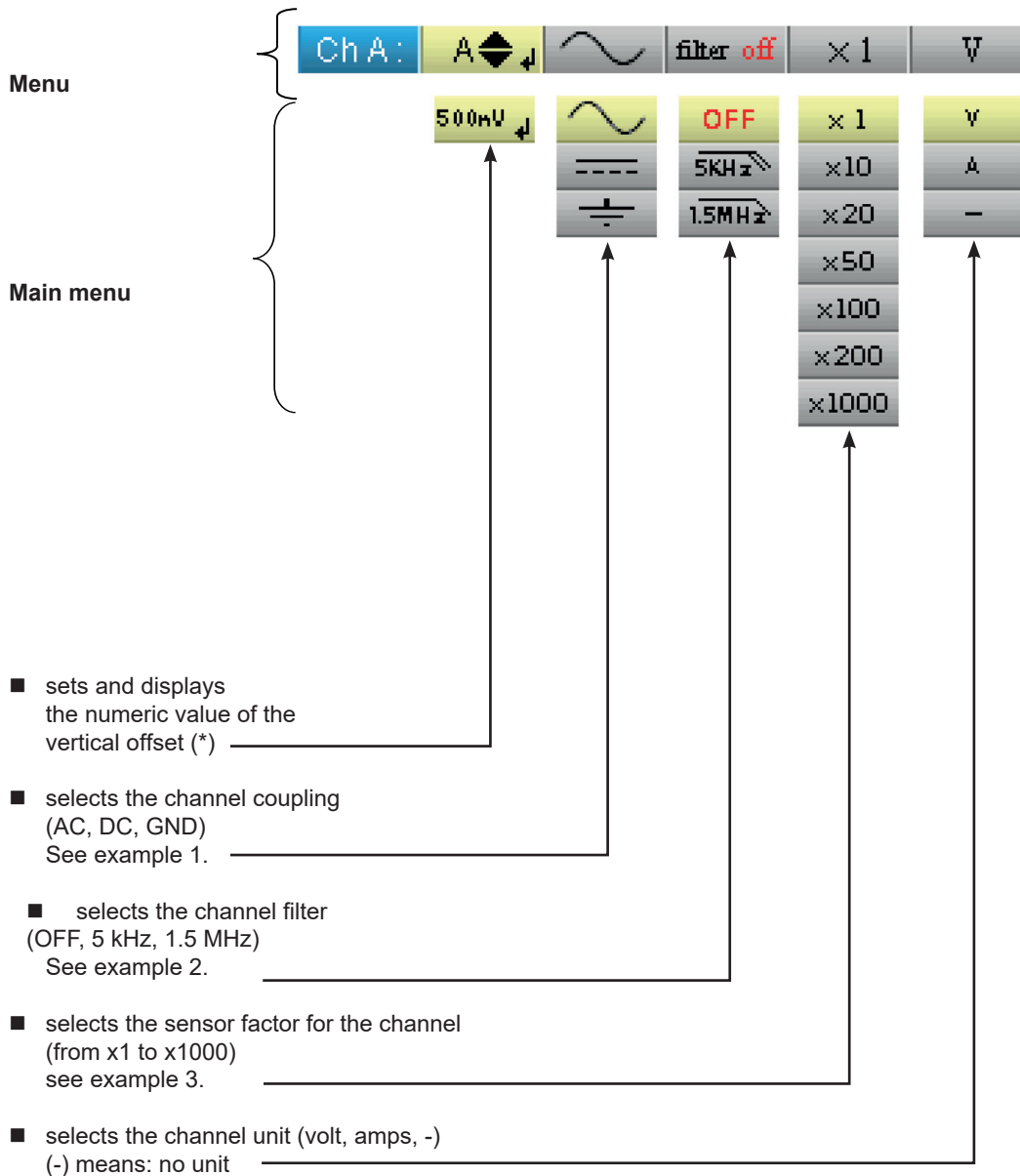

(\*) In the 200 mV/div. range, the position shift must not exceed 3 div. out of the 8 div. available, or the measured signal will be deformed (saturation).



Examples :

### 6.1.1. CHANNEL COUPLING

Injection of a 1 kHz, 2 Vpp amplitude sinusoidal signal with an offset of 0.5 V:

- with AC coupling (the DC component is removed):

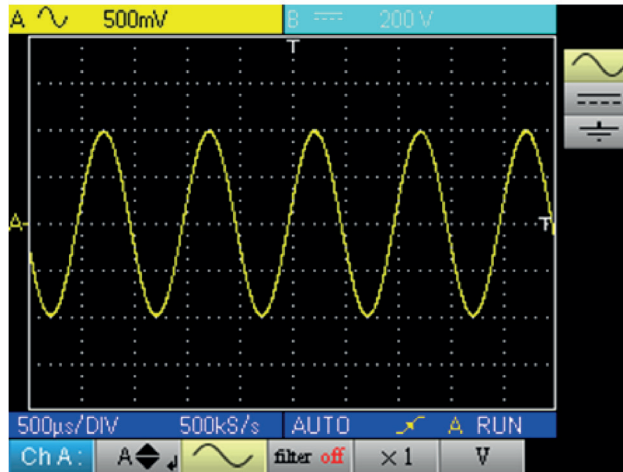

- with DC coupling (the entire signal is measured):

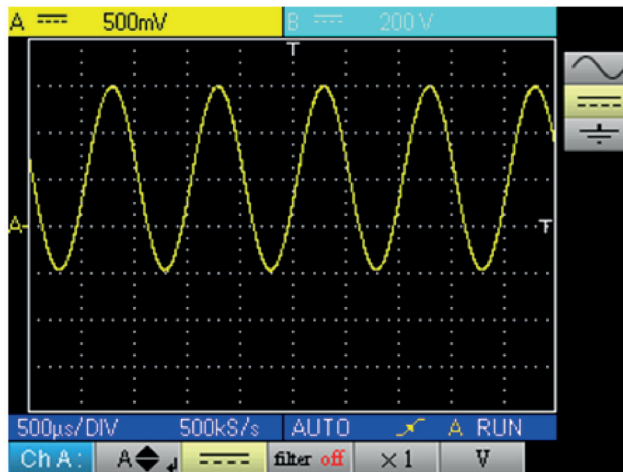

- in GND coupling:

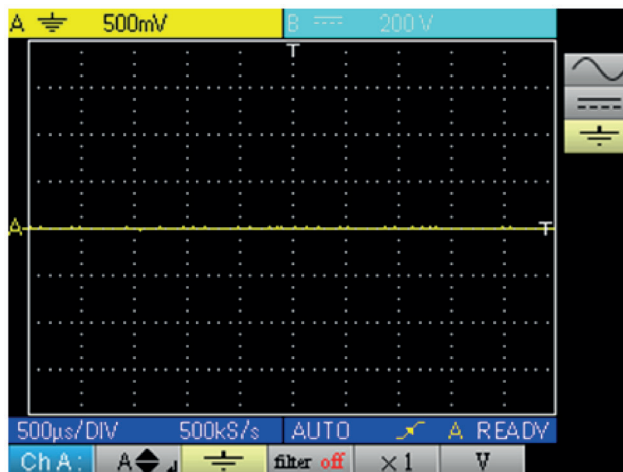

## 6.1.2. CHANNEL FILTER

Superimposition of 2 sinusoidal signals with a frequency of 100 Hz and 3 MHz, respectively:

- without filter (both signals are sent):

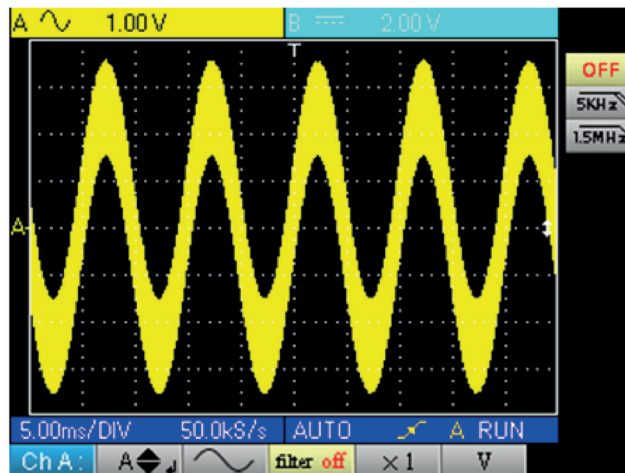

- with the filter 5 kHz low-pass filter (the 3 MHz sinusoidal is cut):

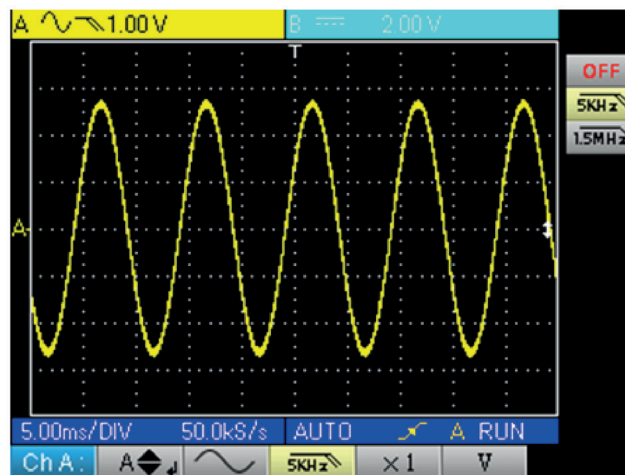

- with the 1.5 MHz low-pass filter (the sinusoidal is partially cut):

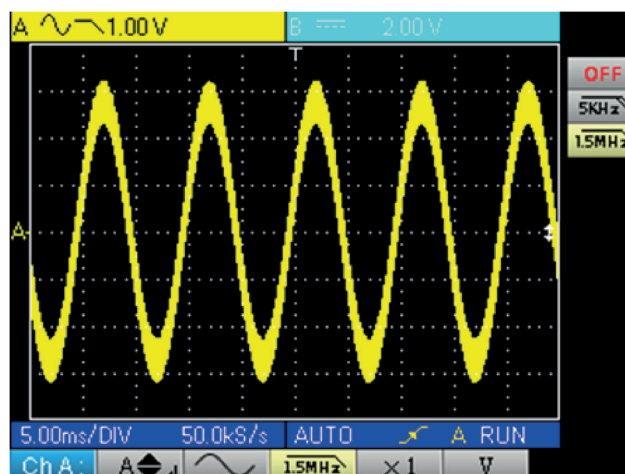



### 6.1.3. SENSOR FACTOR

Observation of a sinusoidal signal of 2 Vpp and 100 Hz with a x 10 sensor:

- with the factor x 1: the amplitudes and sensitivity are incorrect (factor 10)

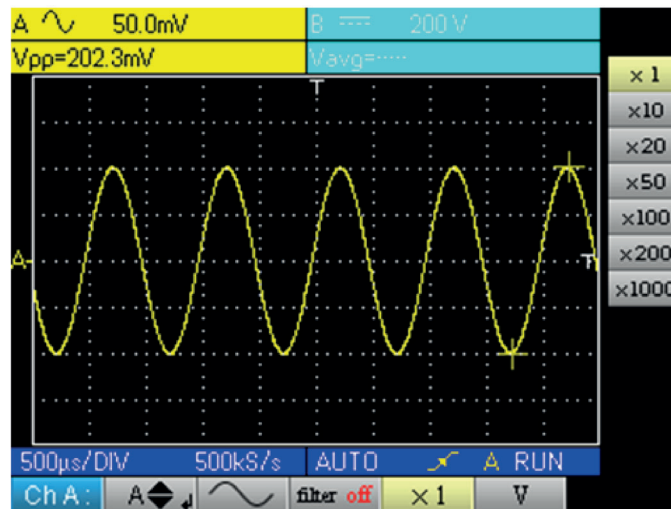

- with the factor x 10: the amplitudes and sensitivities are correct

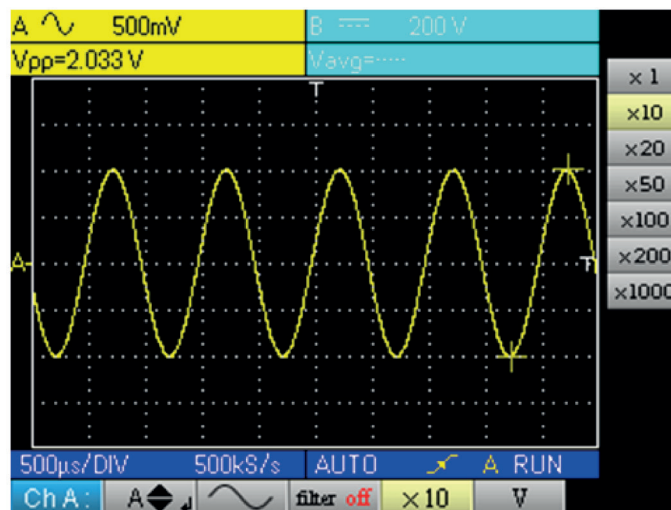

# 7. OSCILLOSCOPE MODE "THE MATH CHANNEL MENU"

## 7.1. THE "M CHANNEL" MENU

**M** Press this key.

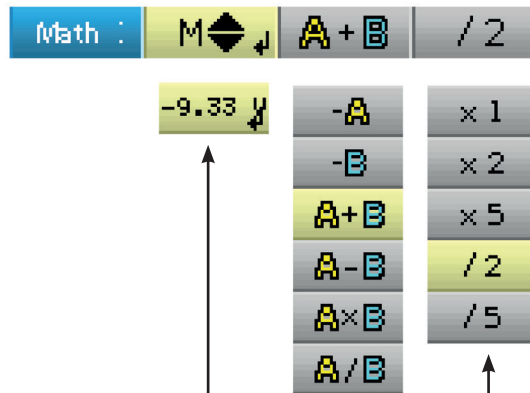

- adjustment of the vertical offset for the Math channel or the stored trace
- selects a mathematical function
- selects the factor for the "Math" function

### 7.1.1. MATHEMATICAL FUNCTIONS

Warning, the calculation of the mathematical functions is not carried out on physical quantities, but on the signal samples. Be careful in particular to use identical sensitivities on channels A and B for addition and subtraction so that the calculation is meaningful. Thus, the sensitivity of the Math channel is determined as follows:

Operation	Sensitivity Channel A	Sensitivity Channel B	Sensitivity Channel M
- A	X	-	X
- B	-	Y	Y
A + B	X	Y = X Y ≠ X	X X ?
A - B	X	Y = X Y ≠ X	X X ?
A x B	X	Y	XY
A ÷ B	X	Y	X ÷ Y



**Example 1:**  $M = A + B$ , addition of a 5 Vpp sine with a 5 Vpp square almost in phase:

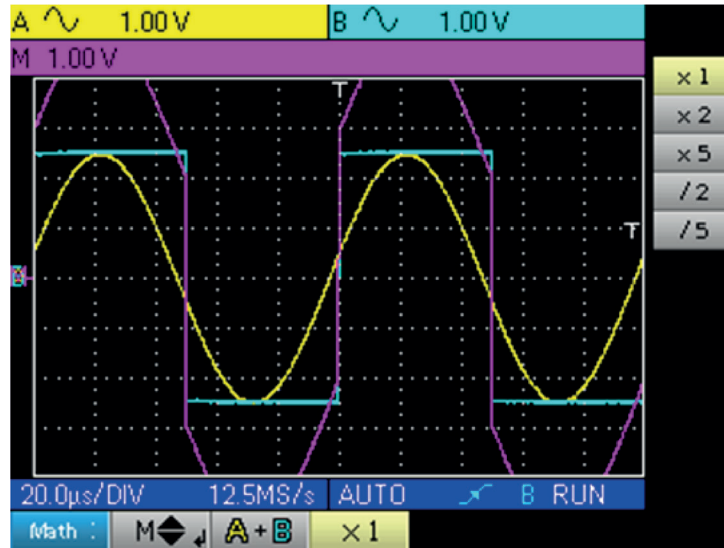

In our example the amplitude of the resulting signal is 10 Vpp. As the sensitivity of channel M is 1 Vpp, it can be seen that the trace overshoots but is contained on the screen by dividing the representation by 2:

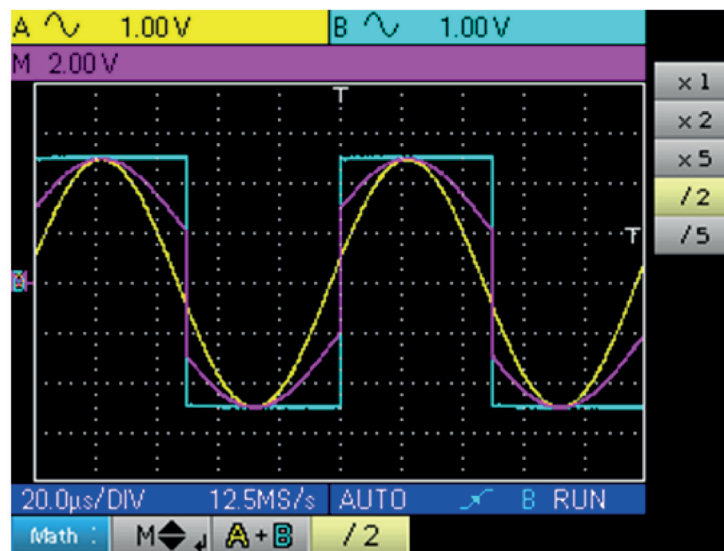

The sensitivity of the M channel becomes 2 V and the amplitude remains at 10 Vpp.



**Example 2:**  $M = A \times B$ , multiplication of a 5 Vpp sine and square almost in phase:

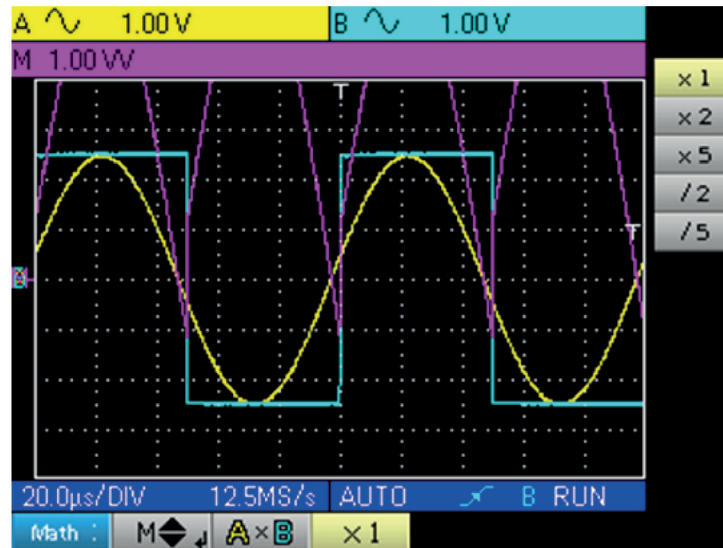

In our example, the peak amplitude of our mathematical function is  $2.5 \text{ V} \times 2.5 \text{ V} = 6.25 \text{ VV}$ . As the channel M sensitivity is 1 VV (with the factor x 1), it can be seen that the trace overshoots and can be corrected by using the /2 coefficient.

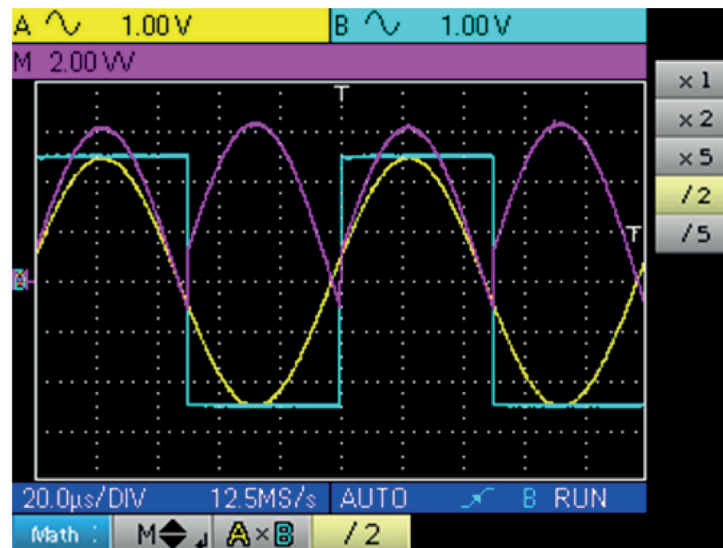

The sensitivity of channel M becomes 2 VV and the peak voltage is  $3.125 \times 2 \text{ VV} = 6.25 \text{ VV}$ .



**Example 3:**  $M = A \div B$ , division of a 5 Vpp sine and square almost in phase:

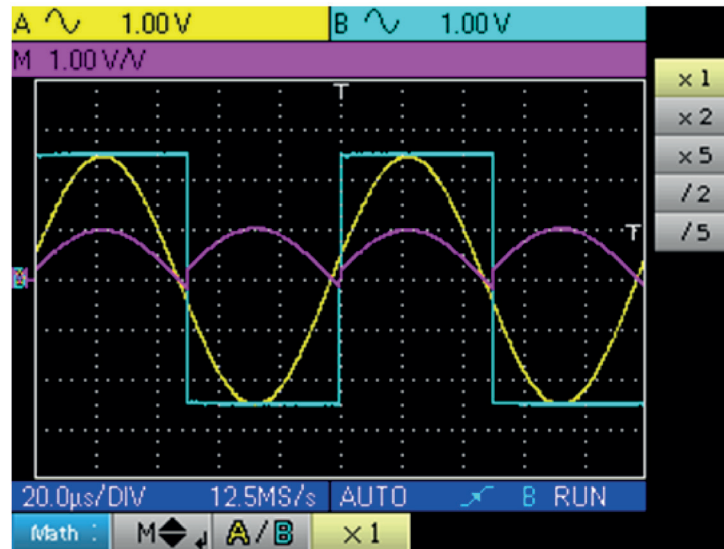

As the positive voltages of signals A and B are equal, the division leads to a positive peak voltage of 1 V/V, and therefore a representation of 1 division on the trace. This can be expanded by choosing factor  $\times 2$  or  $\times 5$ :

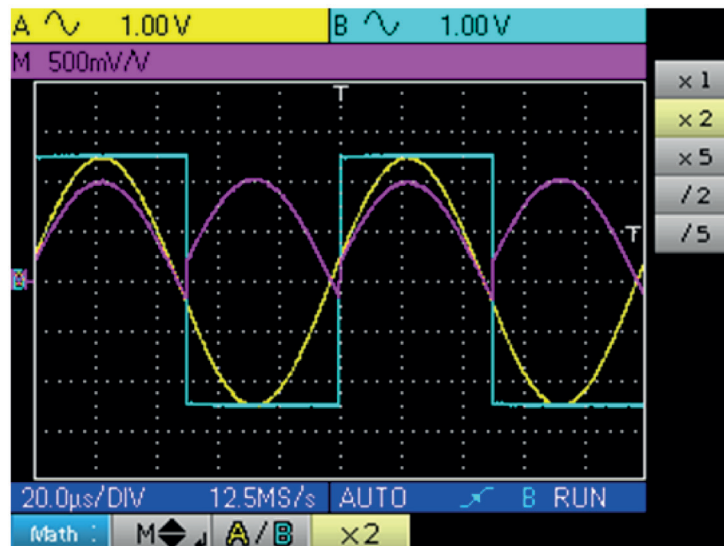

The sensitivity of channel M changes to 500 mV/V and the positive peak amplitude of the trace is 1 V/V.

# 8. OSCILLOSCOPE MODE "THE TRIGGER MENU"

## 8.1. THE "TRIGGER" MENU





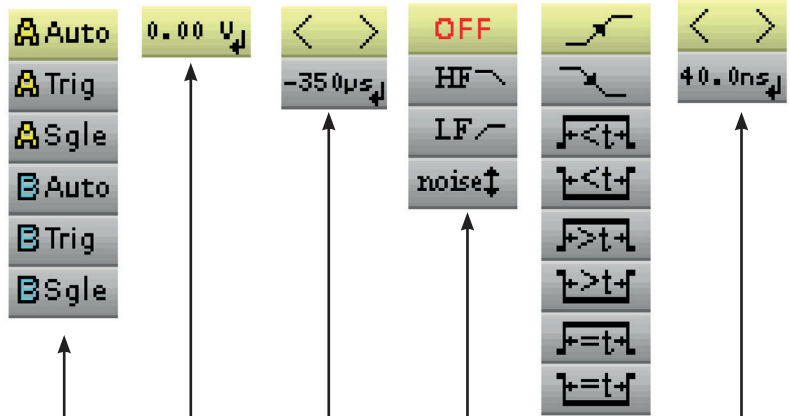



Press this key.



- selects the Trigger source and the trigger mode
- adjusts and displays the vertical trigger level
- sets and displays the event time position in relation to the trace area  
< > used to switch to the other menus
- selects the Trigger filter (OFF, HF Reject, LF Reject, Noise, Hysteresis) See examples 1 and 2.
- selects the Trigger type (front or pulse width)
- sets and displays the numeric value for "t", a parameter of the Pulse Trigger, this setting is only possible for the Pulse Trigger  
< > Exit tab

## 8.2. DESCRIPTION

### 8.2.1. TRIGGER SOURCE AND TRIGGER MODE

Tab	Trigger Source	Triggering mode
	Channel A	automatic
	Channel A	single shot
	Channel A	triggered
	Channel B	automatic
	Channel B	single shot
	Channel B	triggered

- « Single shot » mode:

A single acquisition triggered by pressing the  key opposite is authorised.

- For a new acquisition the triggering circuit must be rearmed by pressing on the key shown opposite.

- « Triggered » mode:

The content of the screen is only refreshed on a triggering event linked to the signals present on the oscilloscope inputs.

In the absence of a triggering event related to the input signals (or the absence of input signals), the trace is not refreshed.

- « Automatic » mode:

The content of the screen is refreshed, even if the trigger level is not detected on the signals on the inputs.

In the presence of a triggering event, the screen refresh is managed as in "triggered" mode.

### 8.2.2. TRIGGER TYPE

 Rising edge trigger

 Falling edge trigger

 Pulse trigger less than "t", with positive pulse

 Pulse trigger less than "t", with negative pulse

 Pulse trigger greater than "t", with positive pulse

 Pulse trigger greater than "t", with negative pulse

 Pulse trigger equal to "t", with positive pulse

 Pulse trigger equal to "t", with negative pulse

## 8.3. EXAMPLES

### 8.3.1. TRIGGER FILTER

Display of a 1 kHz sine with noise (Acquisition Envelope ON)

- without trigger filter (we trigger on the edge of the 1 kHz signal but, depending on the noise value, we trigger on the rising or falling edge):

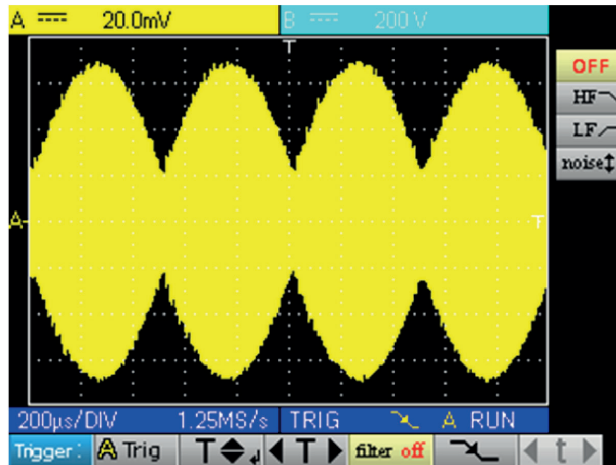

- with the HF reject filter (the noise is filtered, we trigger on the 1 kHz sine):

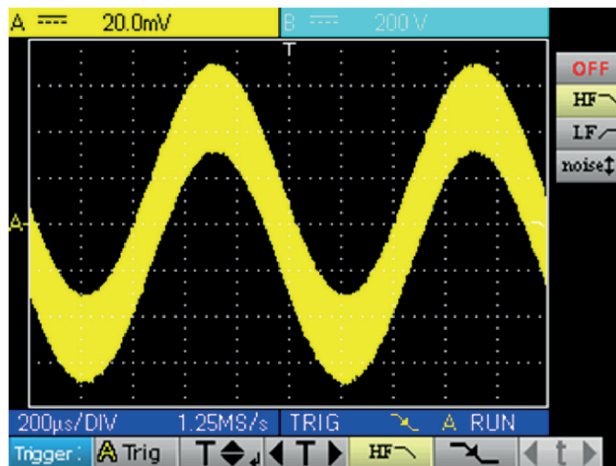

- with the LF reject filter (the 1 kHz signal is filtered, we trigger on the noise → not effective in this case):

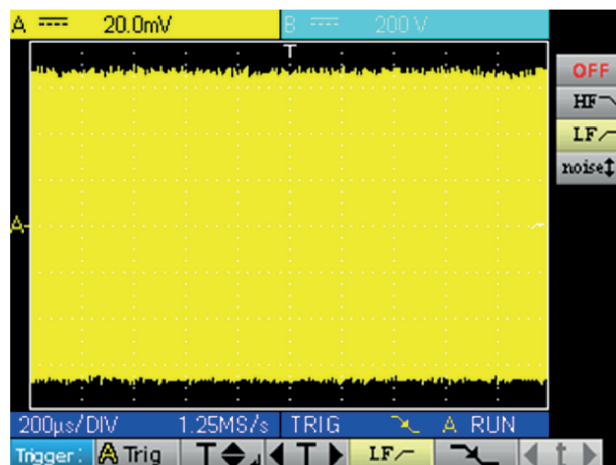



- with the Noise filter (the trigger hysteresis changes to 3 div., we trigger on the 1 kHz sine):

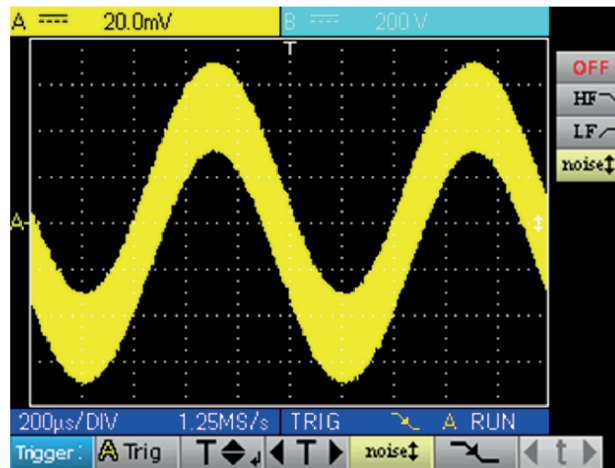

### 8.3.2. OTHER LF REJECT FILTER EXAMPLE

Observation of a slow 10 Hz sine on which peaks show every 200 ms (PkDet activated)

- Case of noise: (we only trigger on the sine edge as it is not easy to zoom on the peaks)

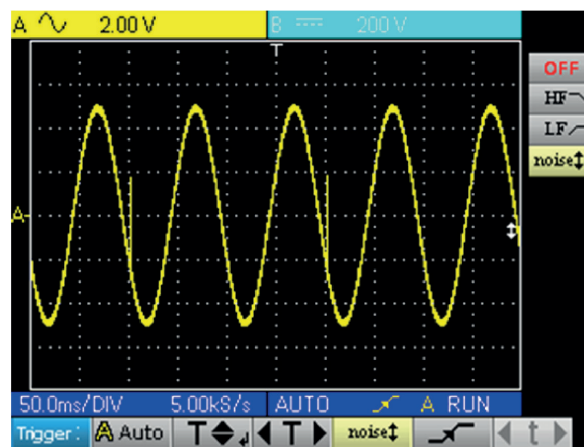

- LF reject case: (we remove the 10 Hz signal and can trigger on the peak and zoom)

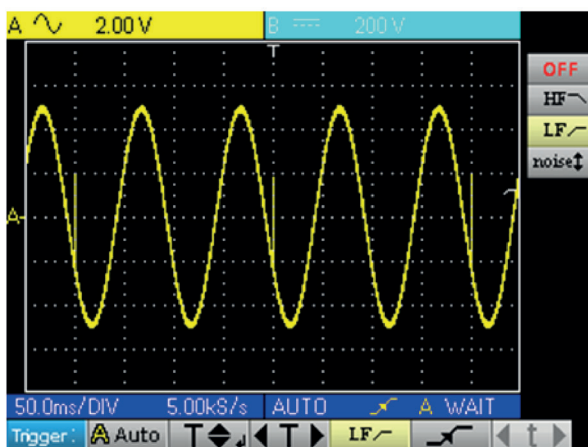

- By changing the time base, the peaks can be observed correctly:

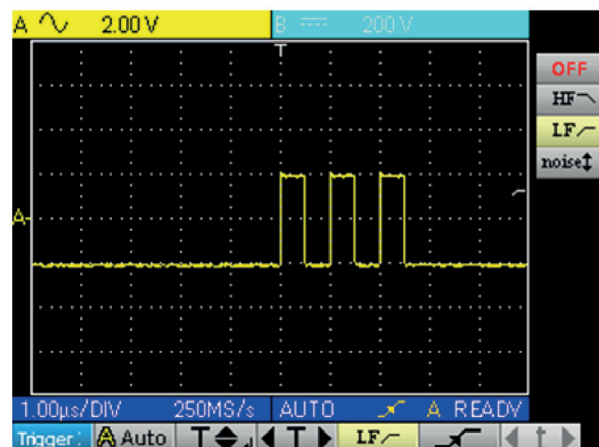



This can also be achieved without a filter, but by selecting triggering on a pulse width of less than  $1\ \mu\text{s}$  :

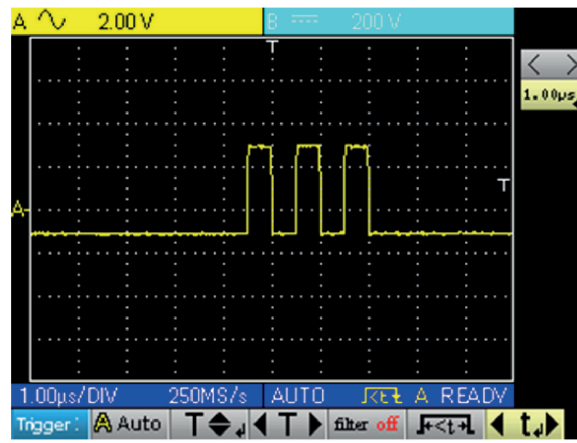

# 9. OSCILLOSCOPE MODE "THE ACQUISITION MENU"

## 9.1. THE "ACQUISITION" MENU



Press this key.

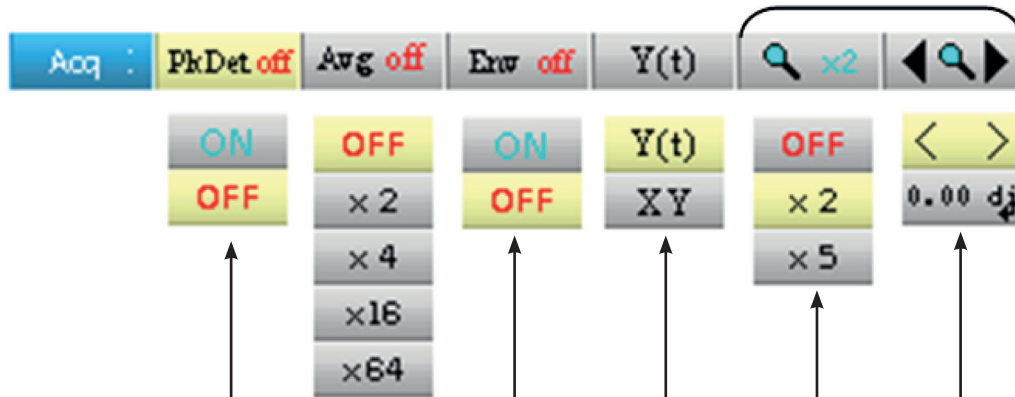

- activates or deactivates the "Peak detection" menu  
See example 1
- selects or deactivates averaging function factor  
See example 2
- activates or deactivates the "Envelope" mode  
See example 3
- selects the time or "XY" mode  
**In the "XY" mode, "CHA" is used as the X-axis and "CHB" as the Y-axis. The "M" channel cannot be represented using "XY" mode. The cursors cannot be activated in this mode.**
- selects or deactivates the "Zoom" factor
- moves the time-based zoom window (this adjustment is only possible if a zoom is active).
- < > Exit tab

## 9.2. EXAMPLES

### 9.2.1. PkDet acquisition

Observation of rapid pulse combs with a low repetition frequency.

- without PkDet (the repetition frequency of the combs gives an inappropriate sampling frequency for viewing the signal, so there are missing combs):

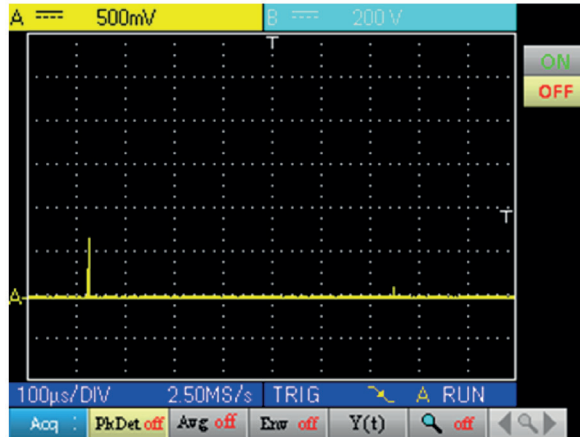

- with PkDet (the detection of the min and max obtained between two sampling steps makes it possible to view all the combs):

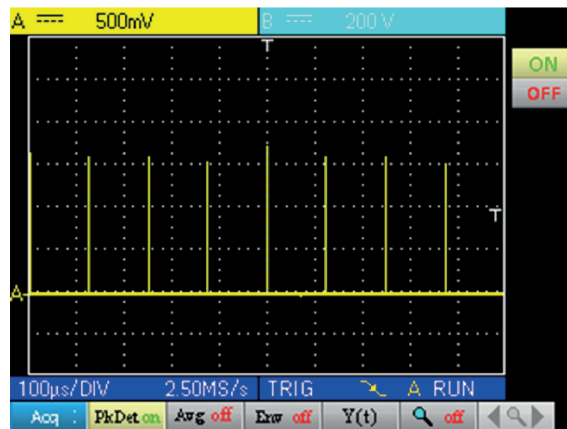

Peak detection deactivates ETS (Equivalent Time Sampling) reconstruction of a repetitive trace. Sampling is real-time for time bases  $\leq 2.5 \mu\text{s}/\text{div}$ .

## 9.2.2. ACQUISITION AVERAGING

Observation of a 1 kHz sine with noise. Prior to averaging make sure that the trace is stable. In our example the Noise filter from the Trigger menu is activated.

- without averaging:

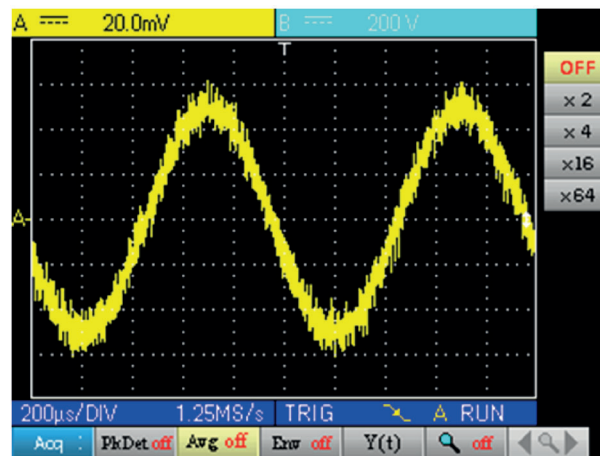

- with x 4 averaging (the noise is reduced) :

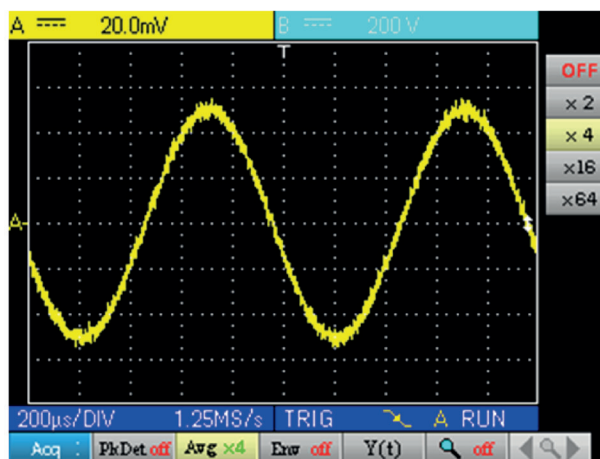

- with x 64 averaging (the noise has almost disappeared) :

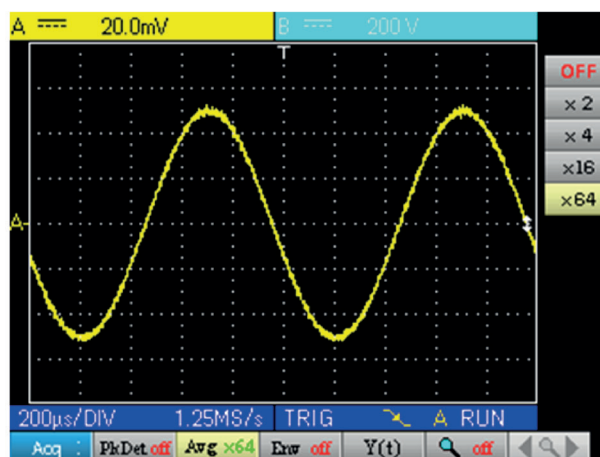

### 9.2.3. ENVELOPE ACQUISITION

Observation of a sinusoidal signal with amplitude modulation.

- without envelope (an acquisition is viewed at each triggering):

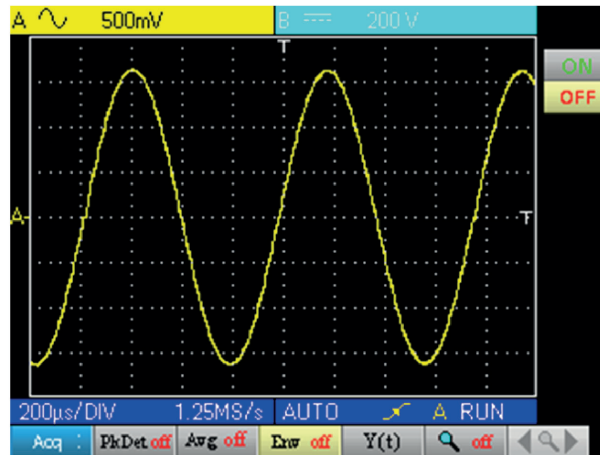

- with envelope (an acquisition is displayed at each triggering):

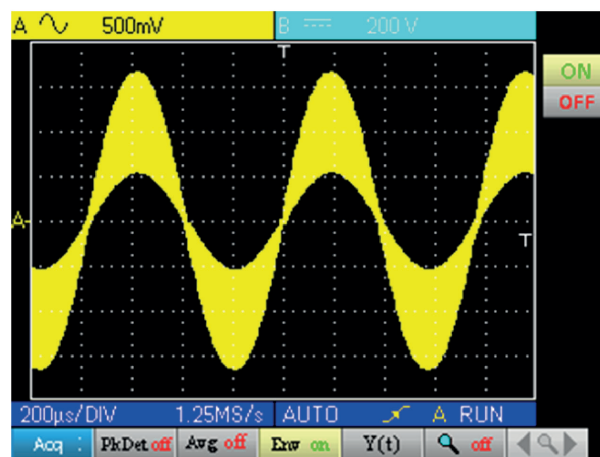

# 10. OSCILLOSCOPE MODE "THE MEASUREMENT MENU"

## 10.1. THE "MEASUREMENT" MENU



Press this key.

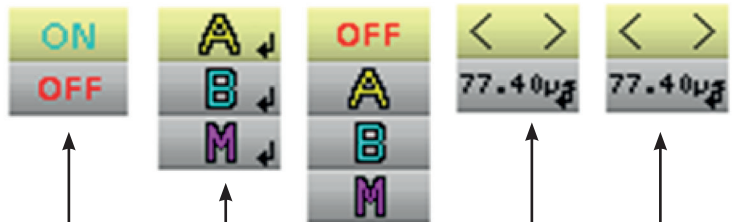

- activates or deactivates automatic measurement display

- used to open the configuration window for automatic measurements on the channel in question (by pressing the key opposite) (\*)



- activates or deactivates cursor measurements

- sets and displays the numeric value of cursor 1 position (\*\*)

- sets and displays the numeric value of cursor 2 position (\*\*)

(\*) This setting is only possible if the automatic measurement display is active.

(\*\*) This setting is only possible if the cursors are active.

10.1.1. DESCRIPTION OF THE CONFIGURATION WINDOW FOR AUTOMATIC MEASUREMENTS

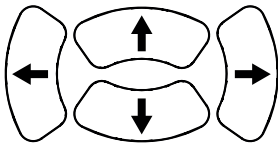
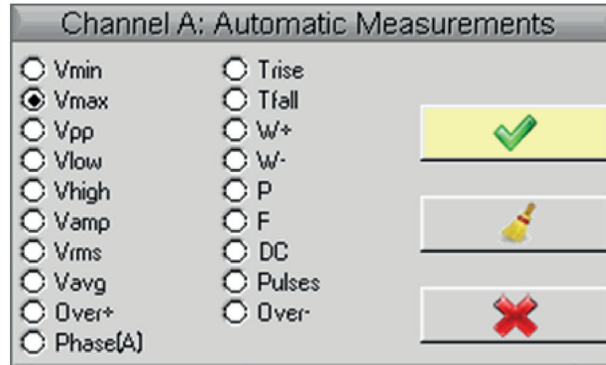

Movement of the selection in the window



Validation of the selection

NAME	MEASUREMENT DESCRIPTION	AUTOMATIC CURSOR INDICATION
Vmin	minimum peak voltage	Vavg and Vmin
Vmax	maximum peak voltage	Vavg and Vmax
Vpp	peak-to-peak voltage	Vmin and Vmax
Vlow	established low voltage	Vavg and Vlow
Vhigh	established high voltage	Vavg and Vhigh
Vamp	amplitude	Vlow and Vhigh
Vrms	root-mean-square voltage	Vrms and measurement interval
Vavg	average voltage	Vavg and measurement interval
Over+	positive offset	Vmin and Vmax
Trise	rise time	points used for the calculation
Tfall	fall time	points used for the calculation
W+	width of positive pulse (at 50% Vamp)	Vavg and points used for the calculation
W-	width of negative pulse (at 50% Vamp)	Vavg and points used for the calculation
P	period	Vavg and points used for the calculation
F	frequency	Vavg and points used for the calculation
DC	duty cycle	Vavg and points used for the calculation
Pulses	number of pulses	Vavg and points used for the calculation
Over-	negative overshoot	Vmin and Vmax
Phase (A)	reference channel B, "channel A phase shift"	Vavg and period used for the calculation
Phase (B)	reference channel A, "channel B phase shift"	Vavg and period used for the calculation



1 or 2 automatic measurements per channel can be selected. The automatic cursors are assigned to the last selected measurement which is displayed in the first position on the screen. When the measurement is possible, the automatic cursors provide an additional indication, see the table above.



### 10.1.2. MEASUREMENT CONDITIONS

- The measurements are made on the entire depth of the acquisition.
- Any modification of the signal causes an update of the measurements. These are refreshed at the same rhythm as the acquisition.
- The accuracy of the measurements is optimal if two complete periods of the signal are displayed.

### 10.1.3. PRESENTATION OF AUTOMATIC MEASUREMENTS

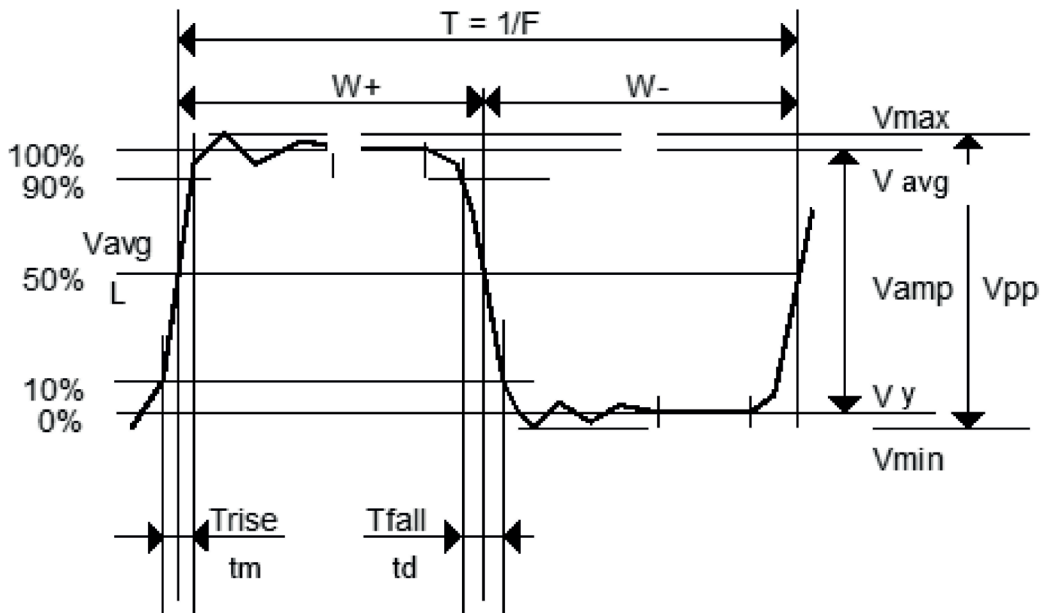

- Positive overshoot =  $[100 * (V_{max} - V_{high})] / V_{amp}$
- Negative overshoot =  $[100 * (V_{max} - V_{low})] / V_{amp}$

$$V_{rms} = \left[ \frac{1}{n} \sum_{i=0}^{i=n} (y_i - y_{GND})^2 \right]^{1/2}$$

$$V_{avg} = \frac{1}{n} \sum_{i=0}^{i=n} (y_i - y_{GND})$$

YGND = value of the point representing zero Volts

### 10.1.4. PHASE MEASUREMENT

Automatic measurement of one trace's phase compared with the other trace.

No phase measurements are possible on the M channel.

The choice of the measurement configuration window (channel A or B) on which the phase measurement is selected conditions the reference channel for the phase-shift measurement.

If the selection is made from the channel A window: channel B becomes the reference channel and the oscilloscope displays the phase shift of channel A in relation to channel B.

# 11. OSCILLOSCOPE MODE "THE MEMORY MENU"

## 11.1. THE "MEMORY" MENU



Press this key.

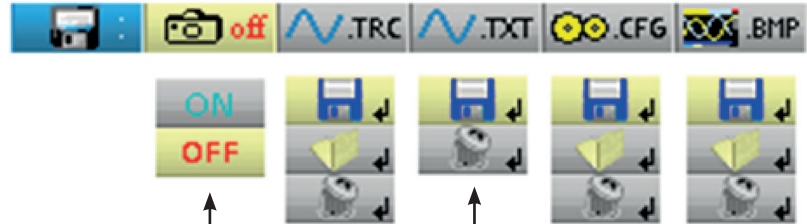

- activates or deactivates the reference display  
See example

- manages stored traces (.trc)

- manages stored traces (.txt)  
**The .txt traces cannot be reloaded on the HandScope but can be used in Spreadsheet software.**

- manages memorised configurations (.cfg)  
**The .cfg files are specific to the HandScope and are not compatible with the brand's other instruments.**

- manages memorised screenshots (.bmp)

### 11.1.1. DEFINITION OF THE COMMON ICONS



gives access to the window for recording a trace, a text trace or a stored configuration or screenshot.



gives access to the trace, configuration or screenshot recall window.



gives access to the window for deleting a trace, configuration, text trace, stored configuration or screenshot.

The file name is generated automatically (e.g. trace\_01.txt, etc.).

### 11.1.2. STORAGE CAPACITY

The memory's capacity is 2 MB (500 kb of which used by File System) and it can be used to store traces, screenshots, configurations and measurement files.

The file names are generated automatically by incrementing the file index from 00 to 99 (e.g.: trace-00.TXT, trace-01.TRC, setup-03.CFG, screen-10.BMP, meter-20.TXT ...).

When the memory is full the message "Error: Memory Full!" appears.

There are 3 possible solutions:



- delete the files one by one using the "Memory" option (→ data is lost).
- transfer the files to a PC via SX-METRO or remote commands (see programming instructions).
- completely reinitialize the memory

 **Warning ! All files will be lost.**

#### Erasing Memory



( 40 Seconds )

1. Turn off the instrument and press  and .
2. While keeping the keys pressed down, press on  and wait for the symbol opposite to appear.
3. The deletion takes about forty seconds.

## 11.2. EXAMPLE

### 11.2.1. TRACE REFERENCE

Observation of a sinusoidal signal with amplitude modulation.

The reference signal appears in light yellow. The amplitude signal is no longer the same as the reference.

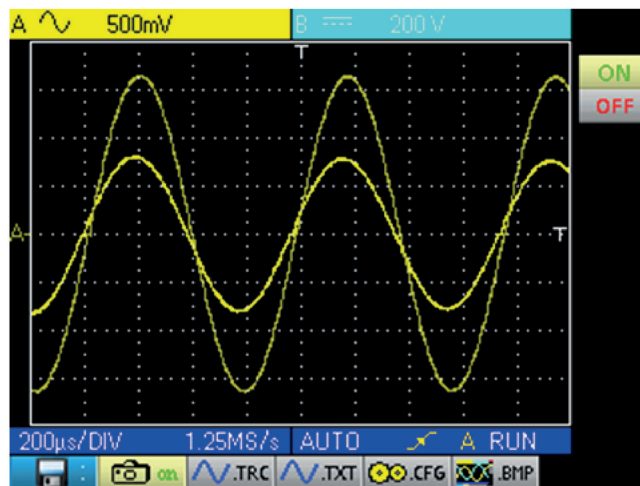

A reference memory is volatile; it is lost when the instrument is powered off, or when the channel or reference is deactivated.

### 11.3. DESCRIPTION

#### 11.3.1. RECORDING MANAGEMENT

- Of a .trc trace
- Of a .txt trace
- Of a .cfg configuration
- Of a .bmp screenshot

Example :

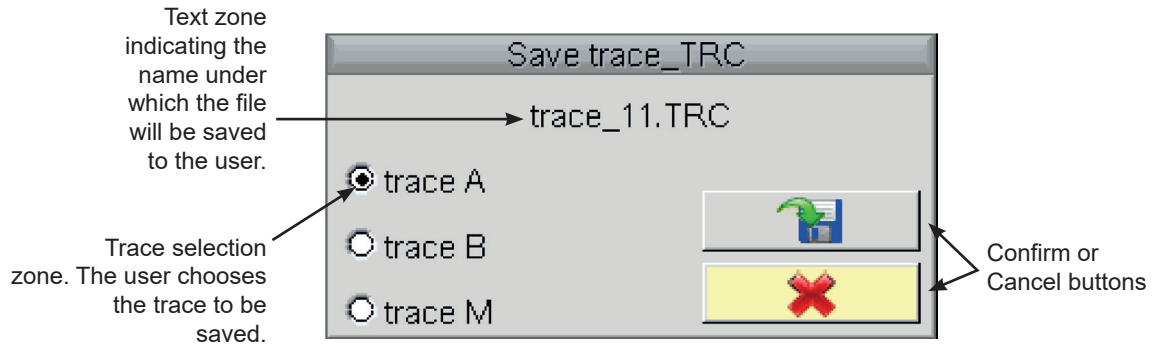

#### 11.3.2. RECALL MANAGEMENT

- Of a .trc trace (the trace is loaded instead of the Math channel)
- Of a .cfg configuration
- Of a .bmp screenshot

Example :

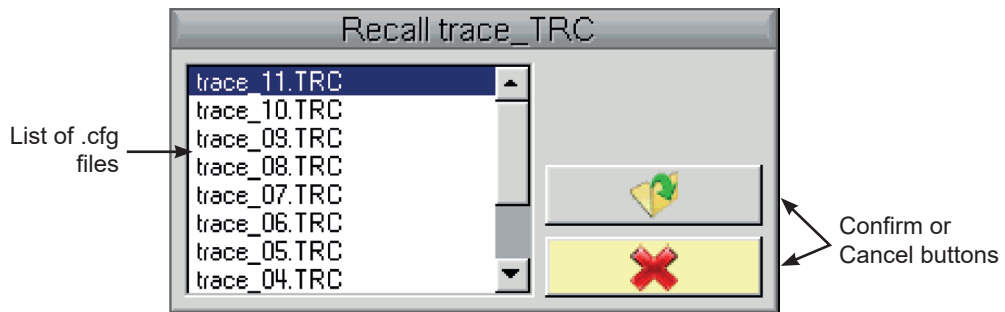

#### 11.3.3. DELETION MANAGEMENT

- Of a .trc trace
- Of a .txt trace
- Of a .cfg configuration
- Of a .bmp screenshot

Example :

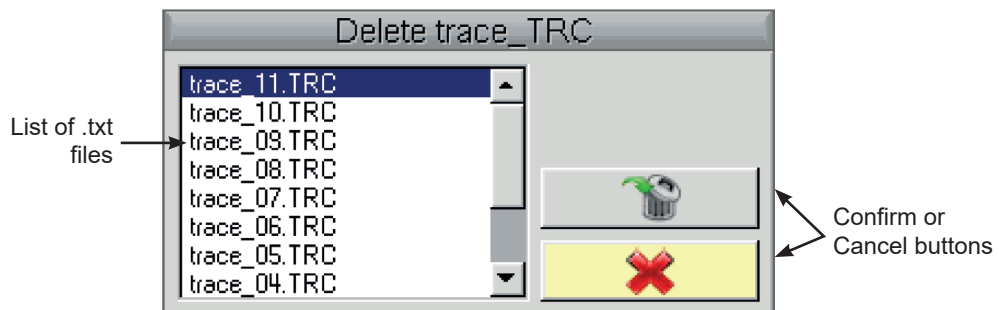

#### 11.3.4. RECOVERY OF THE DATA

The SX METRO software can be used to recover the data of the Oscilloscope mode on a PC.

## 12. OSCILLOSCOPE MODE "THE TOOLS MENU"

### 12.1. THE "TOOLS" MENU



Press this key. This menu is the same in "Multimeter" and "Harmonic analyser" modes.



- selects the language of warning or help messages:



- opens the "Rs / USB Information" window:



- opens the "About ..." window:



#### 12.1.1. THIS WINDOWS GIVES INFORMATION ABOUT:

- the instrument name, the software / hardware version and the serial number
- the startup and acquisition program versions
- the website to visit to obtain news on the METRIX instrument range
- the customer support E-mail address to obtain answers to your questions concerning the instrument

# 13. OSCILLOSCOPE MODE "THE HELP KEY"

## 13.1. THE "HELP" KEY



Press this key to activate / deactivate the integrated help function.  
In all modes it displays a help window for the current menu.

Example:

Main title of the current help

Time display

XY

In XY mode, the horizontal access represents channel A and the vertical axis represents channel B. As in  $y(t)$  mode, the sampling frequency depends on the time-base value. For example, XY mode reveals a phase shift between the signals on channels A and B. In XY mode, the cursors are not available.

Y(t)

XY

A pointer placed opposite the lab of the secondary menu for which help is needed.

Acq : PkDet off Avg x64 Erv off Y(t) off

Pointer placed opposite the lab of the main menu.

Scroll bar; its position can be changed by using the vertical sensibility keys:



## 14. MULTIMETER MODE "THE KEYS"

---



Pressing this key selects the "Multimeter" mode; 2 independent 8,000-count digital multimeters are available.

### 14.1. 6 "MENU" KEYS

Trigger



Inactive in "Multimeter" mode.

Acquisition



Inactive in "Multimeter" mode.

Tools



Displays the main "Tools" menu, identical to the Oscilloscope mode.

Measurement



Inactive in "Multimeter" mode.

Memory



Displays the main "Memory" menu.

Help



Displays the "Help" window, identical to the Oscilloscope mode.

### 14.2. 3 KEYS : CHANNEL A, B AND MATH

Channel



A single press selects channel "A" (or "B") and shows the corresponding menu.

Channel



Pressing twice deselects the channel.

Function



Inactive in "Multimeter" mode.

### 14.3. "TIME BASE" KEYS



Increases the recording time in the viewing window.



Decreases the recording time in the viewing window.

### 14.4. 2 "SENSITIVITY" KEYS



Increases the range of the last selected channel.



Decreases the range of the last selected channel.

### 14.5. FUNCTIONAL KEYS



Inactive in "Multimeter" mode.



The RUN/ HOLD key activates/ deactivates the Hold mode, which freezes the screen.



# 15. MULTIMETER MODE "DISPLAY"

## 15.1. DISPLAY

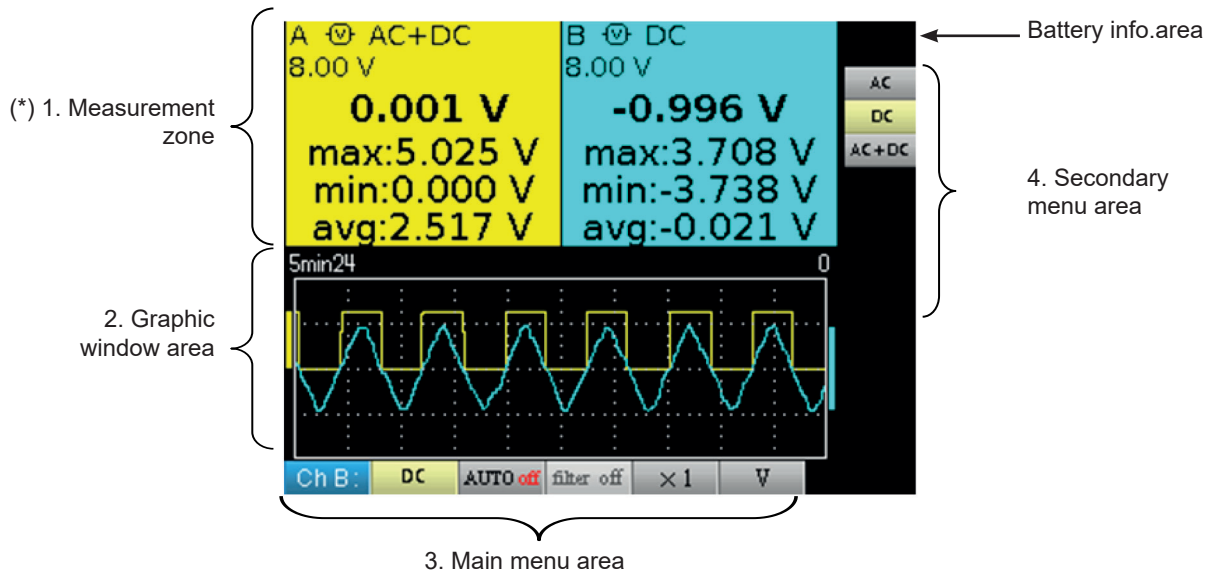

(\*) If the measurement is not possible, dotted lines will be displayed. If the channel is not validated the measurement will be replaced by "-x-".

## 15.2. MEASUREMENT ZONE

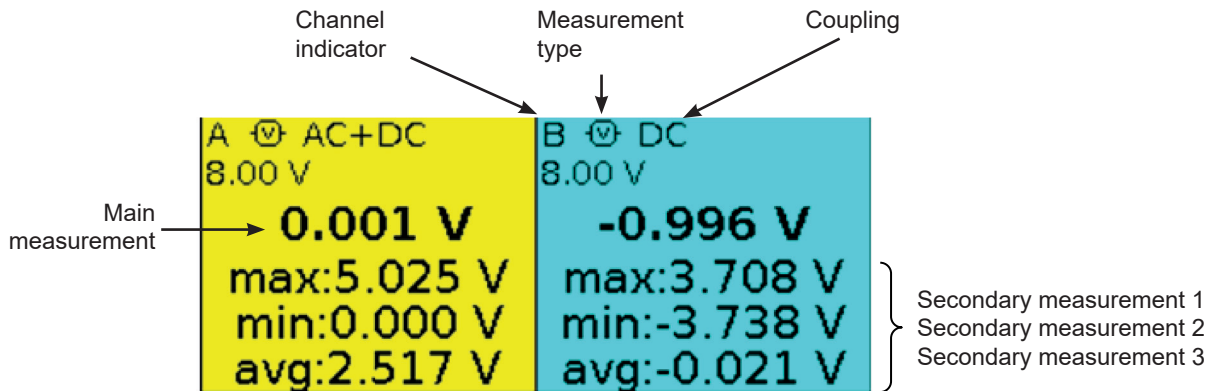

The direct data from channels A and B are displayed in this window:

- Channel indicator
- Coupling
- Filter
- Measurement type
- Main measurement
- Secondary measurement 1
- Secondary measurement 2
- Secondary measurement 3

### 15.3. GRAPHIC WINDOW AREA

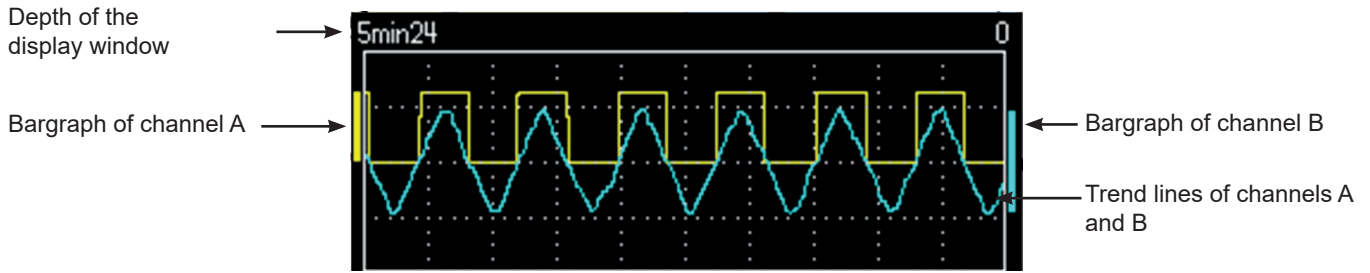

This window shows the measurement changes as a function of time, i.e.:

- the trend curves for the main measurement on each channel
- the reticle
- the operation duration
- a bargraph per channel

#### 15.3.1. TREND CURVE

The trend curve is displayed over 270 points.

#### 15.3.2. OBSERVATION DURATION

The depth of the window represents the observation duration: 2700 measurements are used.

Possible settings: 5'24", 15', 30', 1 hr, 6 hr, 12 hr, 24 hr, 1 week, 1 month.

#### 15.3.3. BARGRAPH

These bargraphs show the min and max measured values.



A range change reinitializes the bargraph and deletes the measurement trend curve.

### 15.4. MAIN MENU AREA

### 15.5. SECONDARY MENU AREA

# 16. MULTIMETER MODE "THE MEASUREMENT MENU"

## 16.1. THE "MEASUREMENT" MENU



Press this key.

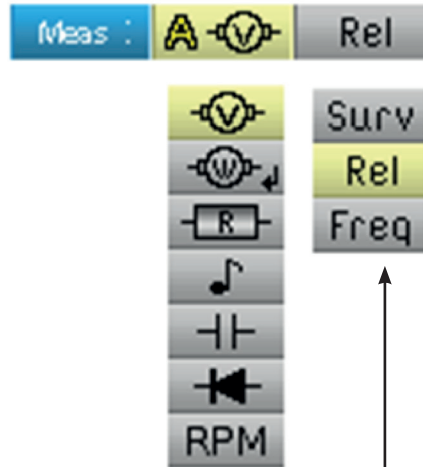

- selects the main measurement on channel "A"
- selects the secondary measurement displayed on the channels

Channel "B" is assigned to voltage measurement, when possible.

## 16.2. DESCRIPTION

### 16.2.1. CHANNEL "A" MAIN MEASUREMENT

- Amplitude measurement
- Active power measurement
- Ohmmeter
- Continuity
- Capacitance meter
- Component test
- Rotation speed measurement (specific sensor CA 1711)

### 16.2.2. POWER MEASUREMENT AND DIALOG WINDOW FOR "MEASUREMENT SELECTION"

When selecting  active power measurement, pressing on  displays the window below. You can thus choose the measurement type:

- Single-phase
- Balanced three-phase without N
- Balanced three-phase with N

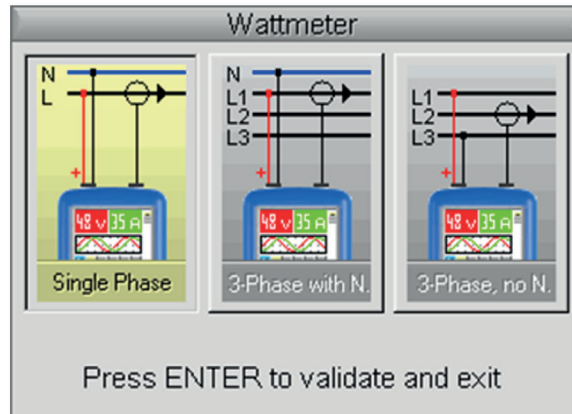

### 16.2.3. DISPLAY OF THE POWER MEASUREMENT AND FORCED TABS

The power measurement imposes the following settings:

- Channel A unit: V (volt)
- Channel B unit: A (ampere)
- Channel A and B coupling: AC

Example : By default the power covers the measurement of channel A; pressing the **A** key is used to view the measurement of channel A, the power then covers the measurement of channel B and vice versa with the **B** key.

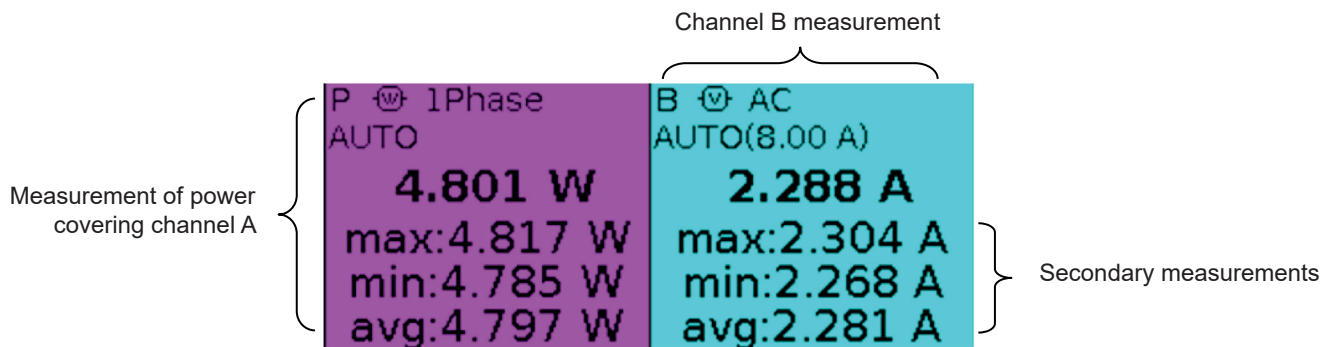

Press the **A** key:

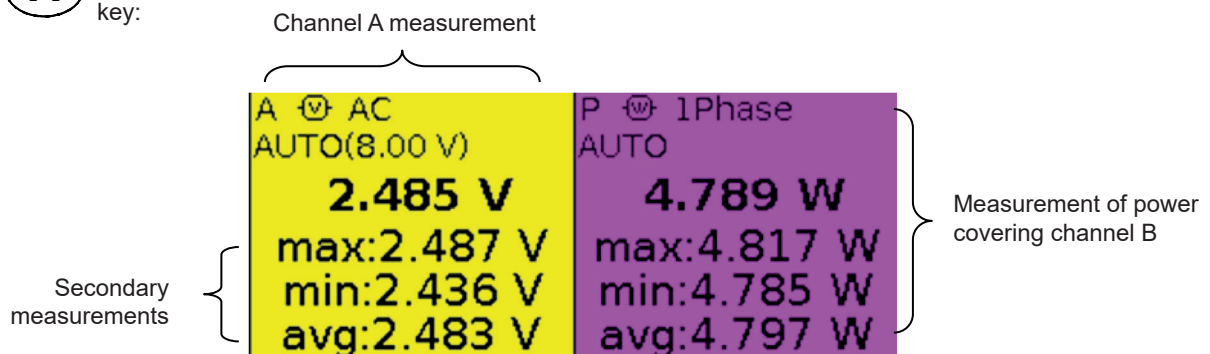

#### 16.2.4. SECONDARY MEASUREMENT

Selects the secondary measurement displayed on the channels:

- Surv** Activates the secondary monitoring measurement. This comprises three measurements:
- min → the minimum measured value
  - max → the maximum measured value
  - avg → the average value since the last reset

- Rel** Activates the relative secondary measurement. This comprises three measurements:
- rel → the difference between actual value and reference value
  - ref → the reference value
  - Δ → the difference in %

- Freq** Activates the secondary frequency measurement. If N is selected, the PF (Power Factor) measurement is displayed.



The choice of secondary measurement is applied to all channels.  
The secondary measurement validated by default is frequency.



You can reset the secondary monitoring or relative measurements by:



- pressing  when the active main menu is the secondary measurement choice menu,
- by temporarily changing the secondary measurement,
- by deactivating and reactivating the channel,
- by changing the range.

# 17. MULTIMETER MODE "THE CHANNEL A OR B MENU"

## 17.1. THE CHANNEL "A" OR "B" MENU

**A** **B** Press one of these two keys:

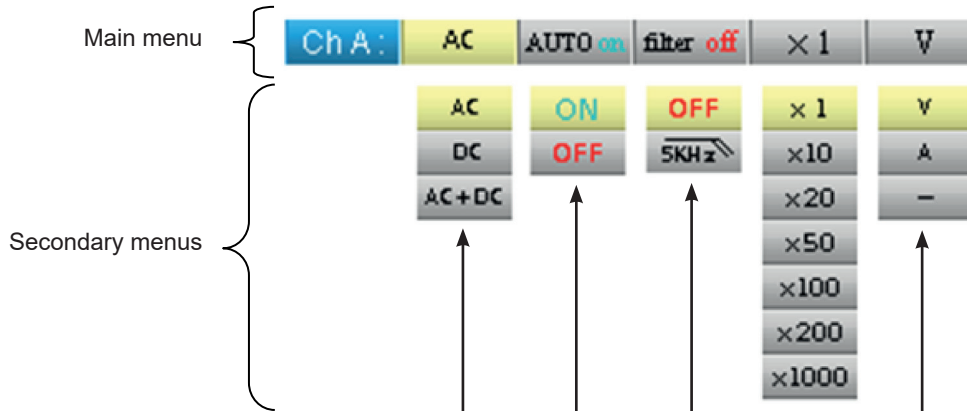

- selects the channel coupling (AC, DC, or AC+DC)  
See example

- activates or deactivates autorange

- selects the channel sensor factor (OFF, 5 kHz)

- selects the channel sensor factor (x1 to x1000)

- selects the channel unit (Volt, Amps, -)

## 17.2. NOTES

(1) These tabs are not accessible if the following types of measurement are validated:

- Capacitance meter
- Ohmmeter
- Component test
- Continuity
- RPM

(2) These tabs are not accessible if the following types of measurement are validated:

- Component test
- Continuity
- RPM

### 17.3. EXAMPLE : MULTIMETER COUPLING

In voltmeter mode, 3 types of coupling are possible:

- AC is used to measure the VAC RMS voltage of the signal without its DC component,
- DC is used to measure the signal's VDC voltage,
- AC + DC gives the VAC + DC RMS voltage of the entire signal.

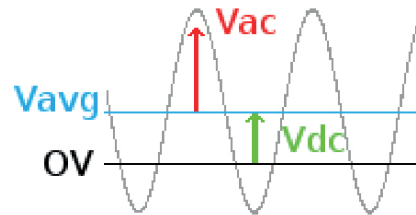

where:  $V_{AC+DC} = \sqrt{V_{AC}^2 + V_{DC}^2}$

# 18. MULTIMETER MODE "THE MEMORY MENU"

## 18.1. THE "MEMORY" MENU



Press this key.

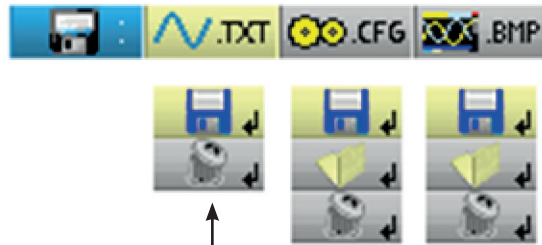

■ selects saved trace management (.txt)

■ selects save configuration management (.cfg)

■ selects saved screenshot management (.bmp)

- The .bmp file can be recovered on a PC using SX-METRO software/ Oscilloscope mode, import memory.
- The multimeter mode of the Handscope is compatible with SX-DMM software v3.



## 19. HARMONIC ANALYSER MODE "THE KEYS"

---



Pressing this key selects the "Harmonic Analyser" mode.

### 19.1. "MENU" KEYS

#### Trigger



Inactive in "Harmonic Analyser" mode.

#### Acquisition



Displays the main "Acquisition and Display" menu: access to orders of harmonics, averaging, zoom.

#### Tools



Displays the main "Tools" menu, id. to the Oscilloscope mode.

#### Measurement



Inactive in "Harmonic Analyser" mode.

#### Memory



Displays the main "Memory" menu.

#### Help



Displays the "Help" window, identical to the Oscilloscope mode.

### 19.2. 3 KEYS CHANNEL "A" + "B" AND MATH



Channel

A single press selects channel A (or B) and shows the corresponding menu.



Channel

Pressing twice deselects the channel.



Function

Inactive in "Harmonic Analyser" mode.

### 19.3. 2 "TIME BASE" KEYS



Inactive in "Harmonic Analyser" mode.



Inactive in "Harmonic Analyser" mode.

### 19.4. 2 "SENSITIVITY" KEYS



Same as "Oscilloscope " mode.



Same as "Oscilloscope " mode.

### 19.5. 2 FUNCTIONAL KEYS



Same as "Oscilloscope" mode.



Inactive in "Harmonic Analyser" mode.

## 20. HARMONIC ANALYSER MODE "DISPLAY"

### 20.1. DISPLAY

The indication using a double black line on the harmonics corresponds to the representation of overshooting harmonics.

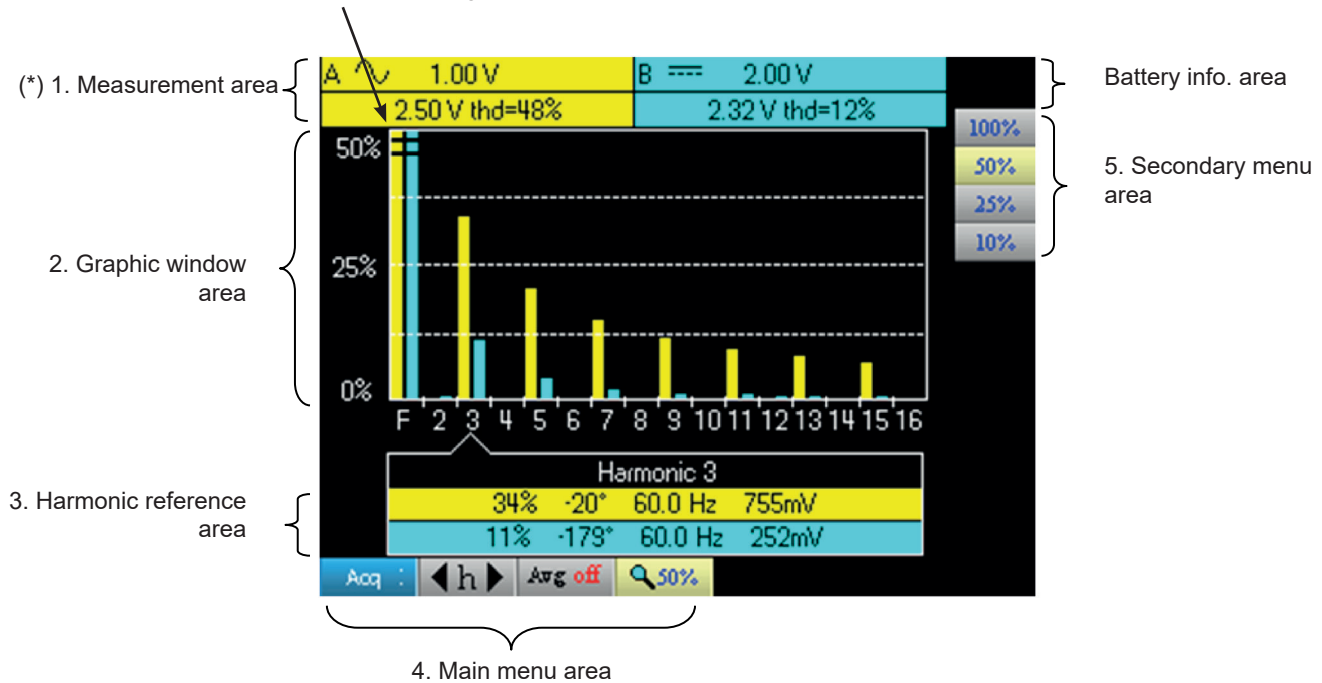

(\*) If no measurement is selected, or if the channel is not validated, the measurement will be replaced by dots.

### 20.2. MEASUREMENT ZONE

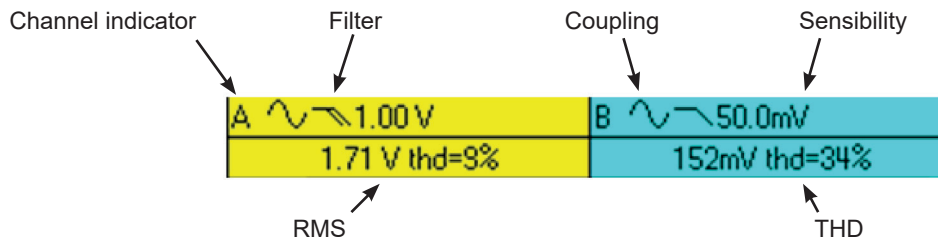

This window displays two measurements and contains data on the channels:

- Channel indicator
- Coupling
- Filter
- RMS voltage of the signal in V
- Total Harmonic Distortion (THD) in %

### 20.3. HARMONIC DISPLAY AREA

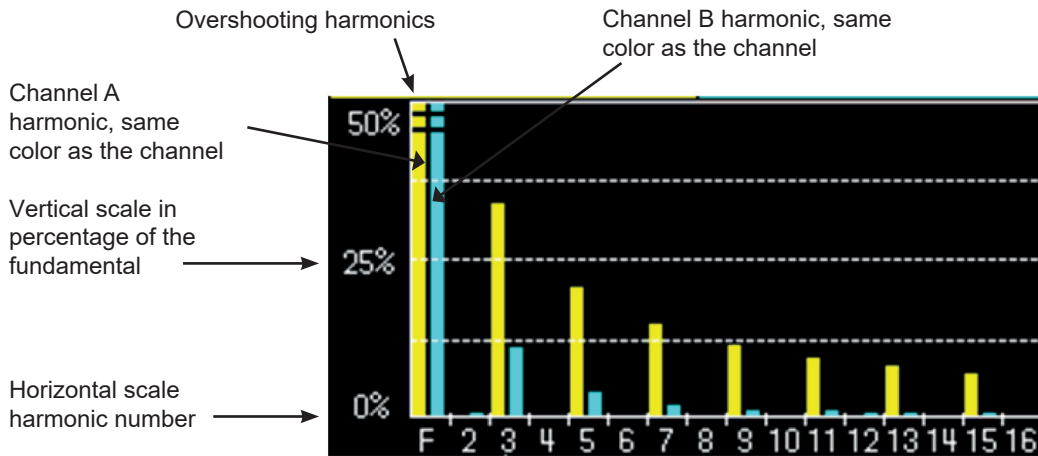

This area displays harmonics 1 to 16 of the validated channels in the form of a bar chart. The user can switch from the display of harmonics 2 to 16 to the display of harmonics 17 to 31. The max. vertical scale will depend on the zoom factor. The zoom factor can be modified using the Acq menu.

### 20.4. HARMONIC REFERENCE AREA

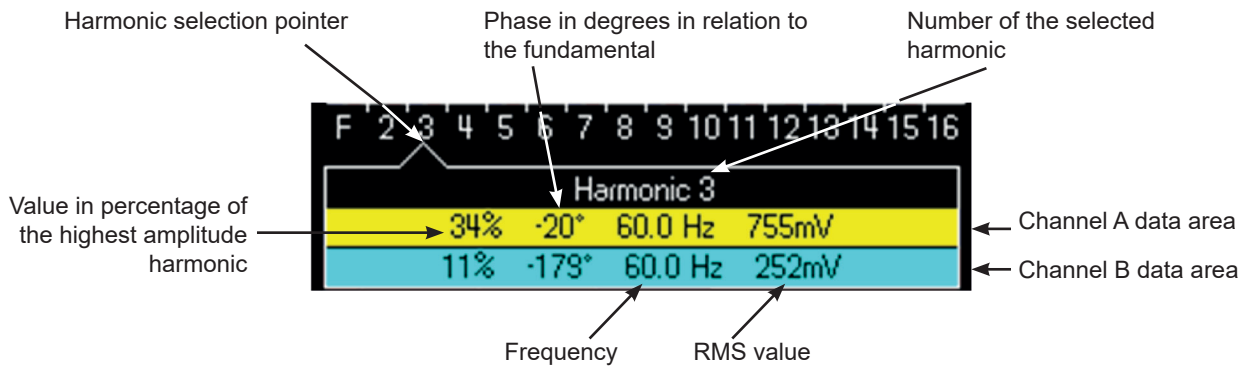

This window displays the specific measurements of the selected harmonic for each channel. The following measurements are displayed:

- the value in % of the highest amplitude harmonic
- the phase in degrees in relation to the fundamental
- the frequency in Hz
- the RMS voltage in V

The title of the group corresponds to the selected harmonic. A different background color will differentiate between channel A and channel B measurements.

### 20.5. MAIN AND SECONDARY MENU ZONES

The menus automatically disappear and full screen mode is activated after about twenty seconds with no action on the keypad. Pressing the button of the menu displays it again.

# 21. HARMONIC ANALYSER MODE "THE CHANNEL A OR B MENU"

## 21.1. THE CHANNEL "A" OR "B" MENU

This menu operates in exactly the same way as when in the "Oscilloscope" mode.



Press one of these two keys.

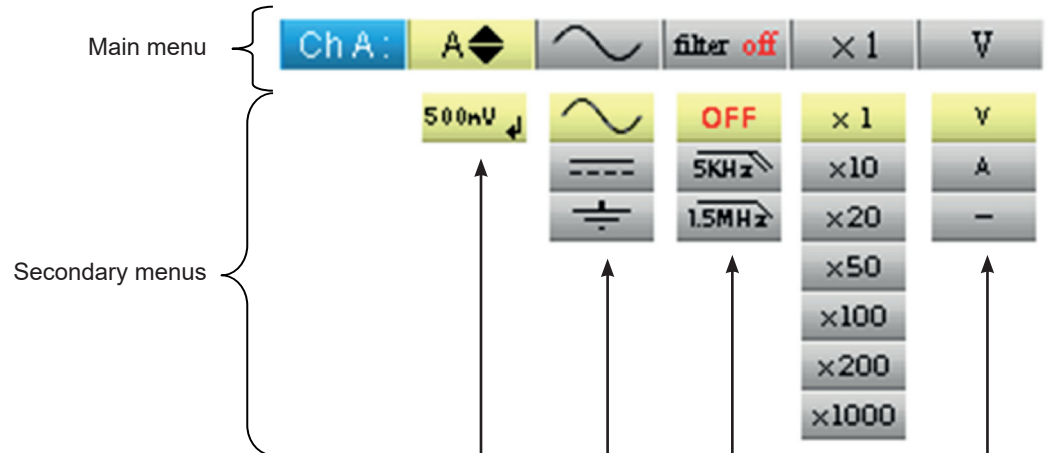

■ displays the numeric offset value

■ selects the channel coupling (AC, DC, GND)

■ selects the channel filter (OFF, 5 kHz, 1.5 MHz)

■ selects the channel factor (from x1 to x1000)

■ selects the channel unit (Volt, Amps, -)

## 22. HARMONIC ANALYSER MODE "ACQUISITION MENU"

### 22.1. THE "ACQUISITION" MENU



Press this key.



- adjusts and displays the number of the selected harmonic



Exit tab

- Average  
Identical to "Oscilloscope" mode

- selects the vertical zoom factor

100%	100 % of the fundamental
50%	50 % of the fundamental
25%	25 % of the fundamental
10%	10 % of the fundamental

The user can change the vertical scale of the harmonics display area so that it is easier to view the harmonics with low amplitude compared with the fundamental.

## 23. HARMONIC ANALYSER MODE "MEMORY MENU"

### 23.1. THE "MEMORY" MENU

This menu operates in exactly the same way as in the "Oscilloscope" mode.



Press this key.



- manages stored configurations (.cfg)

- manages stored screenshots (.bmp)

- The .bmp file can be recovered on a PC using SX-METRO software/ Oscilloscope mode, import memory.

## 24. REMOTE PROGRAMMING

---

### 24.1. PRESENTATION

The oscilloscope can be programmed remotely from a computer:

- either using the SX-METRO software,
- or using basic standardized commands that comply with the IEEE488.2 standard and the SCPI protocol.

This remote programming is used to:

- Configure the instrument
- Perform measurements and retrieve the results
- Transfer files (traces, configuration, screenshots, etc.)

Here we will only describe the connection of the oscilloscope to SX-METRO. For all other use, refer to the remote programming instructions.

### 24.2. CONNECTING THE OSCILLOSCOPE

The dialog between the instrument and the PC is carried out via the USB/optical link provided by the HX0056-Z cable.

- Connect the USB end of the cable to one of the PC USB ports (if necessary install the driver shipped with the cable).
- Connect the optical connector to the oscilloscope after first powering it up.
- Open SX-METRO; select USB communications and wait for communications to be established (in the event of a problem, refer to the SX-METRO instructions).

### 24.3. UPDATING

See § MAINTENANCE section



## 25. TECHNICAL SPECIFICATIONS "OSCILLOSCOPE MODE"

Only the assigned tolerance or limit values are guaranteed (after 30 minutes to adapt to temperature).  
Values without tolerances are given for information purposes only.

### 25.1. VERTICAL DEFLECTION

Specifications	OX 5022B	OX 5042B
Number of channels	2 channels	
Vertical calibers	5 mV to 200 V/div. Variations by step (no continuous variable coefficient)	
BP at -3 dB	20 MHz	40 MHz
	 Measured on a load of 50 Ohms with a 6 div. amplitude signal	
Max input voltage	600 VDC, 600 Vrms Derating : -20 dB per decade from 100 kHz to 40 MHz	
Types of inputs	Safety connector: class 2, insulated inputs	
Dynamics of vertical offset	± 5 div. on all calibers	
Input coupling	AC : 10 Hz to 20 MHz DC : (0 to 20) MHz GND : reference	AC : 10 Hz to 40 MHz DC : (0 to 40) MHz GND : reference
Bandwidth limit	1.5 MHz	5 kHz
Rise time	approx. 17.5 ns	approx. 8.75 ns
Cross-talk between channels	> 60 dB same sensitivity on both channels	
Response to 1 kHz and 1 MHz rectangular signals	Positive or negative overshoot Overshoot ≤ 4 %	
Vertical display resolution	± 0.26 % of the full scale at the best (without measurements, without cursors)	
Accuracy of peak-to-peak gains	± 2 % with averaging of 4 at 1 kHz	
Accuracy of vertical measurements in DC with offset and averaging of 16	± [2.5 % (reading) + 13 % (sensitivity) + 0.5 mV] Applies to the following measurements: Vmin, Vmax, Vlow, Vhigh, Vavg, vertical cursors	
Accuracy of vertical measurements in AC without offset at 1 kHz and averaging of 16	± [2 % (reading) + 2 % (sensitivity)] Applies to the following measurements: Vamp, Veff, Dep+, Dep-	
Sensors	The attenuation factor is to be applied in the channel menu	
Vertical ZOOM function on an acquired or stored curve	none	
Electrical safety without accessories	600 V, CAT III, double insulation	
Max. voltages	floating: 600 V, CAT III from (50 to 400) Hz between channels: 600 V, CAT III from (50 to 400) Hz Frequency derating from 401 Hz to 100 kHz: 300 V MAX	
Input impedance	1 MΩ ± 0.5 % approx. 17 pF	
Measurements on PWM variator	measurements only on installation not exceeding 400 V three-phase	
Spurious capacitance between the grounds of channels A and B	approx. 340 pF	

## 25.2. HORIZONTAL DEFLECTION (TIME BASE)

Specifications	OX 5022B	OX 5042B
<b>Time base calibers</b>	from 25 ns to 200 s/div. such that: <ul style="list-style-type: none"> <li>■ Actual time: from 200 s/div. to 5 <math>\mu</math>s/div.</li> <li>■ ETS: from 2.5 <math>\mu</math>s/div. to 125 ns/div.</li> <li>Zoomed ETS: 50 ns/div. and 25 ns/div.</li> </ul> For time bases from 200 s/div. to 100 ms/div., the samples are displayed as soon as the trigger is present.	
<b>Accuracy of the time base</b>	$\pm [500 \text{ ppm} + 0.04 \text{ div.}]$ (equ. to $\pm [0.05 \% + 0.04 \text{ div.}]$ )	
<b>Sampling frequency</b>	50 MSps in real time 2 GS/sec. in ETS	
<b>Accuracy of time measurements</b>	$\pm [(0.02 \text{ div.}) \times (\text{time/div.}) + 0.01 \times \text{reading} + 5 \text{ ns}]$	
<b>Horizontal ZOOM</b>	Zoom factor: x 1, x 2 and x 5  In ZOOM mode there is the same time-base caliber sequence as in normal mode. The horizontal screen resolution is 540 points for 10 divisions.	
<b>XY Mode</b>	The bandwidths are identical in X and Y (see §. Vertical offset). As in the standard mode, the sampling frequency depends on the time base value.	
<b>Phase error</b>	$< 3^\circ$	

## 25.3. TRIGGER CIRCUIT

<b>Trigger sources</b>	A, B	
<b>Trigger mode</b>	Automatic/Triggered/One shot (roll if the time base $\geq 100$ ms/div.)	
<b>Trigger coupling with band limitation</b>	DC (default): (0 to 20) MHz HFreject: (0 to 10) kHz LFreject: 10 kHz to 20 MHz	DC (default): (0 to 40) MHz HFreject: (0 to 10) kHz LFreject: 10 kHz to 40 MHz
<b>Trigger slope</b>	Rising or falling edge	
<b>Trigger sensitivity (without noise rejection)</b>	1.2 div. peak-to-peak from DC to 20 MHz	1.2 div. peak-to-peak from DC to 40 MHz
<b>Noise rejection</b>	$\pm 1.5$ div.	
<b>Vertical trigger Variation range</b>	$\pm 8$ div.	
<b>Horizontal trigger Variation range</b>	Trig after delay (from -10 div. up to the left of the screen)	
<b>Trigger type</b>	edge	
	pulse width	$< t \approx t > t$
		$< 20 \text{ ns to } 20 \text{ s}$

## 25.4. ACQUISITION CHAIN

Specifications	OX 5022B	OX 5042B
Resolution of the ADC	9 bits	
Maximum sampling frequency	50 MS/s in real time / 1 converter per channel	
Transient capture MIN/MAX mode	Minimum width for detectable glitches: > 20 ns	
	1250 MIN/MAX couples	
Depth of acquisition memory	2500 pts per channel	

## 25.5. FORMATS OF THE DIFFERENT FILES

Specifications	OX 5022B	OX 5042B
Backup memory	Managed in a file system Total size 2 MB (500 kB of which used by File System) to store various objects: <ul style="list-style-type: none"> <li>■ traces</li> <li>■ configurations</li> <li>■ screenshots</li> </ul>	
Trace files acquired in SCOPE mode Extension : .TRC ex. : trace-xx.TRC	Binary format Size: ≈ 10 ko	
Configuration files Extension : .CFG ex. : setup-xx.CFG	Binary format Size: ≈ 1 ko	
Image files Extension : .BMP ex. : screen-xx.BMP	Binary format Size: .BMP: ≈ 75 ko	
Files containing text Extension : .TXT ex. : trace-xx.TXT ex. : meter-xx.TXT	Text format The .TXT extension files can contain measurements made using the instrument's different acquisition modes.	
	Trace acquired in SCOPE mode Size: ≈ 25 ko.	
	Measurement in Meter mode Size: ≈ 80 ko.	

## 25.6. MEASUREMENT PROCESSING

### 25.6.1. MATHEMATICAL FUNCTIONS

Choose from:

- opposite
- addition
- subtraction
- multiplication
- division

The display is adjusted using a factor: / 5, / 2, x 1, x 2, x 5.

### 25.6.2. AUTOMATIC MEASUREMENTS

#### Time measurements

- rise time
- fall time
- positive pulse
- negative pulse
- duty cycle
- period
- frequency
- phase (A % B)
- meter

#### Level measurements

- DC voltage
- RMS voltage
- peak-to-peak voltage
- amplitude
- max. voltage
- min. voltage
- upper plateau
- lower plateau
- overshoot

**Measurement resolution** : Display on 4 digits

### 25.6.3. CURSOR

- Accuracy of vertical measurements  $\pm [2.5 \% (\text{reading}) + 13 \% (\text{sensitivity}) + 0.5 \text{ mV}]$
- Accuracy of time measurements  $\pm [0.02 \times (t/\text{div.}) + 0.01 \% (\text{reading}) + 5 \text{ ns}]$
- Operation The cursors are attached to the curve.

## 25.7. DISPLAY

Specifications	OX 5022B	OX 5042B
Display screen	LCD 3.5 in TFT (color display) Backlit LED	
Resolution	1/4 VGA, i.e. 320 horizontal pixels x 240 vertical pixels	
Window viewed in normal mode	Complete memory: 2500 540 pts from the 2500 in the complete memory	
Display modes	<p><b>Entire acquisition</b> Display of all the samples acquired in a burst with linear interpolation between 2 acquired points (default mode)</p> <p><b>Min/Max</b> Display of min and max on each X axis acquired in a burst.</p> <p><b>Envelope</b> Display of min and max on each X axis acquired in several bursts.</p> <p><b>Averaging</b> Factors from: none, 2, 4, 16, 64</p>	
Reticle	Complete and borders	
Screen indication	<p><b>Triggering</b> Position of the triggering level (with coupling and overshoot indicator). Position of the Trigger point on the zoom indicator and the upper edge of the screen (with overshoot indicators).</p> <p><b>Traces</b> Trace identifiers, trace activation: position, sensitivity, earth reference, high and low overshoot indicators if traces outside screen.</p>	

### 25.7.1. OTHER

1/10th Sensor calibration signals	<p>Form: rectangular</p> <p>Amplitude: 0 - 3 V</p> <p>Frequency: <math>\approx</math> 1 kHz</p> <p> Connect the sensor cold point to the cold point of the sensor calibration output</p>
Autotest	<p>Search time &lt; 5 s</p> <p>Frequency range &gt; 10 Hz</p> <p>Amplitude range 10 mVpp to 400 Vpp</p> <p>Duty cycle limits from (20 to 80) %</p>

## 26. TECHNICAL SPECIFICATIONS "ACCESSORIES"

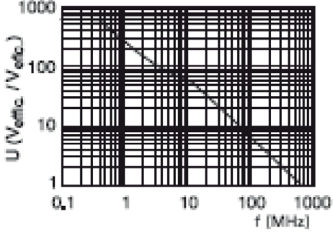
<p style="text-align: center;"><b>1/10 Sensor</b></p> 	<p>Measurement category Bandwidth Input capacitance Compensation range Rise time Input impedance DERATING Accessories</p>	<p>600 V CAT III DC to 500 MHz 12 pF 12 pF to 25 pF 0.9 ns 10 MΩ see opposite wire holder and earth alligator clip</p>
<p style="text-align: center;"><b>BNC Banana adapter</b></p>	<p>Measurement category Diameter</p>	<p>600 V CAT III 4 mm</p>
<p style="text-align: center;"><b>Measurement cable</b></p>	<p>Measurement category Diameter Termination</p>	<p>600 V CAT III 4 mm test probe</p>
<p style="text-align: center;"><b>Current clamp</b></p>	<p>Measurement category Connection</p>	<p>600 V CAT III BNC</p>
<p style="text-align: center;"><b>Active thermocouple adapter</b></p>	<p>Adapter for K thermocouple</p> <p>Measurement range Transformation ratio Choice of unit Accuracy Accuracy LED Particularity Connection Operating range Battery</p>	
<p style="text-align: center;"><b>Infrared temperature sensor</b></p>	<p>Measurement range Transformation ratio Accuracy Distance Connection Operating range Battery</p>	<p>(- 30 to 550) °C 1 mV / °C ± (2 % ± 2°C) between 5 cm and 30 cm banana (0 to 50) °C, &lt; 80 % HR 9 V</p>
<p style="text-align: center;"><b>Tachometer</b></p>	<p>Measurement range Signal Accuracy Distance Connection Operating range Battery</p>	<p>(6 to 120,000) RPM pulse ± 0.5 % between 5 cm and 30 cm banana 0 to 50 °C, &lt; 80 % HR 9 V</p>

## 27. TECHNICAL SPECIFICATIONS "MULTIMETER MODE"

Only the assigned tolerance or limit values are guaranteed (after 30 minutes to adapt to temperature). Values without tolerances are given for information purposes only.

<b>Display</b>	8000 points for voltmeter			
<b>Entry impedance</b>	1 M $\Omega$			
<b>Max input voltage</b>	600 Vrms sine and 600 VDC, without sensor			
<b>Max floating voltage</b>	600 Vrms up to 400 Hz CAT III			
<b>DC measurement</b>				
Ranges	0.8 V	8 V	80 V	800 V
Resolution	0.1 mV	1 mV	10 mV	0.1 V
Accuracy	$\pm (1 \% + 20 D)$ in DC from (10 to 100) % of scale			
Common mode rejection	> 60 dB to 50 or 60 Hz			
<b>AC and AC+DC measurements</b>				
Ranges	0.6 V 0.8 V	6 V 8 V	60 V 80 V	600 Vrms sine 800 Vpeak
Resolution	0.1 mV	1 mV	10 mV	0.1 V
Coupling accuracy	$\pm (1 \% + 20 D)$ from DC to 5 kHz of (10 to 100) % of scale $\rightarrow$ 580 Vrms			
AC+DC	$\pm (2 \% + 20 D)$ from (5 to 10) kHz		id.	
	$\pm (3 \% + 20 D)$ from (10 to 50) kHz		id.	
	$\pm (1 \% + 20 D)$ from 40 Hz to 5 kHz		id.	
AC	$\pm (2 \% + 20 D)$ from (5 to 10) kHz		id.	
	$\pm (3 \% + 20 D)$ from (10 to 50) kHz		id.	
Common mode rejection	> 60 dB to 50 or 60 Hz			
<b>Resistance measurement</b>	<b>On channel 1</b>			
Ranges (end of scale)	<b>Ohmmeter</b>	<b>Resolution</b>	<b>Measurement current</b>	
	80 $\Omega$	0.01 $\Omega$	0.05 mA	
	800 $\Omega$	0.1 $\Omega$	0.5 mA	
	8 k $\Omega$	1 $\Omega$	5 $\mu$ A	
	80 k $\Omega$	10 $\Omega$	5 $\mu$ A	
	800 k $\Omega$	100 $\Omega$	500 nA	
	8 M $\Omega$	1000 $\Omega$	50 nA	
	32 M $\Omega$	10 k $\Omega$	50 nA	
Accuracy	$\pm (2 \% + 10 D + 0.2 \Omega)$ from (10 to 100) % of scale			
Voltage in open circuit	$\approx 3$ V			
<b>Continuity measurement</b>	<b>On channel 1</b>			
Beeper	< 30 $\Omega \pm 5 \Omega$			
Measurement current	$\approx 0.5$ mA			
Beeper response	< 10 ms			
<b>Diode test</b>	<b>On channel 1</b>			
Voltage	in open circuit: $\approx + 3.3$ V			
Accuracy	$\pm (1 \% + 10 D)$			
Measurement current	$\approx 0.6$ mA			

<b>Capacitance measurement</b>	<b>On channel 1</b>			
	Ranges	<b>Capacitance meter</b>	<b>Resolution</b>	<b>Measurement current</b>
		5 mF	1 $\mu$ F	500 $\mu$ A
		500 $\mu$ F	0.1 $\mu$ F	500 $\mu$ A
	50 $\mu$ F	0.01 $\mu$ F	500 $\mu$ A	
	5 $\mu$ F	1 nF	500 $\mu$ A	
	500 nF	100 pF	50 $\mu$ A	
	50 nF	10 pF	2 $\mu$ A	
	5 nF	1 pF	2 $\mu$ A	
Accuracy	$\pm (2 \% + 10 D + 200 \text{ pF})$ from (10 to 100) % of scale			
Cancellation of serial and parallel R	Parallel R > 10 k $\Omega$ Use the shortest possible cables.			
<b>Frequency measurement</b>	20 Hz to 50 kHz on sine and square signals 20 Hz to 20 kHz on a triangle signal Accuracy: 0.3 %			
<b>RPM measurement</b>	from (240 to 120,000) RPM Pulse measurement: > 10 $\mu$ s exceeding 1.5 V with a hysteresis of 1 V. One pulse corresponds to one rotation.			
<b>PWM measurement with PWM filter + E27 clamp</b>	300 V CAT III Refer to the operating instructions of the filter.			

<b>Operating modes</b>		
Relative mode	Display in relation to a REF base measurement	The Relative, Monitoring and Frequency modes are exclusive.
Monitoring (statistic)	On all measurement values MAX MIN AVG	
Frequency	Possible display of the frequency in AC mode	
Measurement history	Display of the measurement = f (time) 5 ft (default), 15 ft, 30 ft, 1 hr, 6 hr, 12 hr, 24 hr, day, month	
RUN	Start measurements	
HOLD	Freeze the measurement	

<b>Display</b>		
In numeric form	- of the main measurement $\rightarrow$ large scale display - of the secondary measurement $\rightarrow$ small scale display	The secondary measurement can be selected from the menu.
Graphic trace	History of measurements over time Presentation of the measurements in the form of an amplitude bar chart	
Number of measurements represented on the trace	2700	



## 28. NETWORK "HARMONIC ANALYSIS MODE "

---

<b>Display of harmonics</b>	
	All of harmonics from 2 to 16 + Fundamental from 17 to 31 + Fundamental
<b>Fundamental frequency of the signal analyzed</b>	from (40 to 50) Hz
<b>Measurement accuracy</b>	
	Fundamental level $\pm (2.5 \% + 15 D)$
	Level of harmonics $\pm (3.5 \% + 15 D)$
	Harmonic distortion (THD) $\pm 4 \%$ (calculated on the first 40 harmonics)

## 29. COMMUNICATION INTERFACES

---

### 29.1. USB/OPTICAL INTERFACE

The oscilloscope can communicate with a computer via a USB link using the HX0056-Z adapter cable.

#### 29.1.1. SPECIFICATIONS OF THE OPTICAL LINK

Bauds speed selection: 57600  
Parity selection: none  
Word length selection: 8 bits  
Selection of the nr. of stop bits: 1 stop bit  
Selection of the protocol: none (no protocol)

## 30. GENERAL SPECIFICATIONS

### 30.1. ENVIRONMENT

- Reference temperature (18 to 28) °C
- Operating temperature (0 to 40) °C
- Storage temperature (-20 to +60) °C
- Indoor use
- Altitude < 2000 m
- Relative humidity < 80 % up to 35 °C

### 30.2. POWER SUPPLY

- **Rechargeable battery** 6 x 1.2 V - LR6 or AA
  - Type NiMH
  - Charge time approx. 3h30
  - Min. battery life approx. 5h45
  - Max. battery life approx. 8h30  
(1 channel deactivated, AC coupling)
- **USB external power supply** Battery charger
  - Network voltage (98 to 264) V from
  - Frequency (50 to 60) Hz < 11
  - Consumption VA in operation  
≅ 19 VA fast charging
  - Voltage 5 VDC  
2 A
- Polarity 

### 30.3. CE

- **Safety** Compliant with IEC 61010-1 and IEC 61010-2-030 :
  - Insulation class 2
  - Pollution degree 2
  - Overvoltage category  
for "measurement" inputs: 600 V CAT III

#### ■ EMC

This instrument complies with the IEC 61326-1 standard.

It has been tested for industrial environments (class A).

In other environments and under special conditions compatibility may be difficult to ensure.

- Emission Class A
- Immunity Influence: 0.5 div. in the presence of an electromagnetic field of 10 V/m

**Attention: This instrument is not intended for use in residential environments and cannot ensure adequate protection of radio reception in this type of environment.**

**Note: For use with the jack to USB cord (with a ferrite) must be used.**

## 31. MECHANICAL SPECIFICATIONS

### 31.1. BOX

- Dimension (214 x 110 x 57) mm
- Oscilloscope weight 0.960 kg with battery
- Power supply weight 0.160 kg

### 31.2. PACKAGING

- Dimensions (25 x 16.5 x 14.5) cm

## 32. SUPPLY

### 32.1. ACCESSORIES

#### 32.1.1. SHIPPED WITH THE OSCILLOSCOPE

- User Manual En and software SX Metro on USB Drive
- External USB power supply 5 V, 2 A + USB to jack cable
- 6 NiMH 1.2 V rechargeable batteries - typ LR6 or AA
- Small Classic Tool Bag
- 1/10 600 V CAT III Voltage probe X 2
- BNC adapter to Ø 4 mm connectors
- Ø 4 mm « banana/banana » connectors red black
- Test probe red black
- Alligator clip red black
- Serial-USB optical cable

#### 32.1.2. ORDERING INFORMATION OX5022B

##### Description

Handscope Portable Oscilloscope Model OX5022B (Special Order Only)..... **Cat. #2150.20**

#### 32.1.3. ORDERING INFORMATION OX5042B

##### Description

Handscope Portable Oscilloscope Model OX5042B..... **Cat. #2150.21**

Handscope Model OX5042B w/MN251T & MF 3000-24-1-1 (BNC Output)..... **Cat. #2150.22**

Handscope Model OX5042B w/MN379T & MF 3000-24-1-1 (BNC output;  
Low AC Current Measurement)..... **Cat. #2150.23**

#### 32.1.3.1. Accessories and Replacement Parts - Available on website store at [www.aemc.com/store](http://www.aemc.com/store)

Probe 10:1 600 V BNC Male for use with Model OX5042..... **Cat. #5000.50**

Set of 2, Color-coded Grip Probes (Red/Black) 1000 V CAT II ..... **Cat. #2124.86**

Small Classic Tool Bag (replacement pouch)..... **Cat #2133.72**

AC Current Probe Model MN251T..... **Cat. #2132.59**

MiniFlex® 3000-24-1-1..... **Cat. #2132.63**

Lead - Set of 2, Color-coded 10 ft (3 m) Rated 600 V CAT IV  
w/ Color-coded alligator clips (Red/Black)..... **Cat. #2140.63**

AC Current Probe Model MN379T..... **Cat. #2153.02**

AC/DC Current Probe Model MH60..... **Cat. #2153.03**

Adapter Banana (Female) - BNC (Male)..... **Cat. #2118.46**

Replacement 5 V, 2 A USB power adapters are commercially available.

## 33. MAINTENANCE

---

### 33.1. CLEANING

- Disconnect the measurement probes or leads.
- Power down the instrument.
- Use a soft cloth moistened with soapy water.
- Rinse with a damp cloth.
- Dry rapidly with a dry cloth or forced air.
- Do not use alcohol or a hydrocarbon or other solvent.

Do not use the instrument again until it is completely dry.

### 33.2. UPDATING THE INTERNAL SOFTWARE OF THE INSTRUMENT

- Log into the site <http://www.chauvin-arnoux.com>
- Under the "Support" heading, select "Download Space"
- Download the Firmware corresponding to the model of your instrument using the embedded Metrix "LoaderScope" oscilloscope software
- Also download the operating instructions of this Firmware
- Refer to these operating instructions when updating your instrument.

## 34. WARRANTY

---

This equipment is guaranteed for three years against defects of materials or workmanship, under the general terms of sale.

During this period, the instrument can be repaired only by the manufacturer, which reserves the right to repair or replace the whole instrument or part thereof. If the equipment is sent back to the manufacturer, shipping is paid by the customer.

The warranty is void following:

- improper use of the equipment or use in association with incompatible equipment,
- any modification of the equipment without express authorization by the manufacturer's technical staff,
- work on the equipment done by a person not approved by the manufacturer,
- adaptation to a particular application not anticipated in the specifications of the equipment or in the operating instructions, a shock, a fall, or flooding.

# 35. REMOTE PROGRAMMING MANUAL

## 35.1. PRESENTATION

The oscilloscope can be remotely programmed with a computer, from simple standardized commands and using the optical interface USB-RS.

The programming instructions comply with standard IEEE488.2, and the SCPI protocol (Standard Commands for Programmable Instruments).

This remote programming enables :

- Instrument configuration
- Measurement recordings and their repatriation
- File transfer (traces, configuration, hard copy...)

## 35.2. CONNECTION OF THE INSTRUMENT

The dialog between the instrument and the PC can be realized via the optical USB link through the HX0056-Z cable.

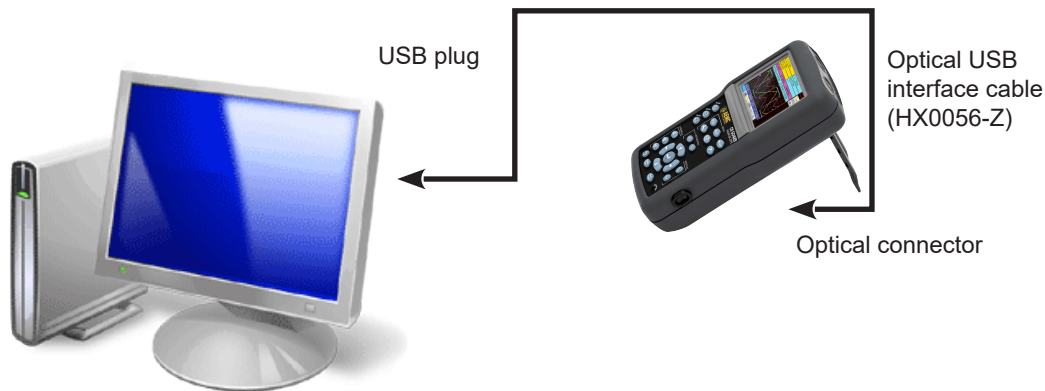

- Connect the USB side of the cable to one of the PC USB inputs.
- If necessary, install the USB driver supplied with the cord.
- The PC's operating system creates a virtual communication port COM*i* (with '*i*' number depending on your computer).
- Configure the PC port created on the PC to the same parameters as those of the oscilloscope.

### 35.2.1. OPTICAL LINK SPECIFICATIONS

- |                |             |
|----------------|-------------|
| ■ Speed        | 57600 bauds |
| ■ Format       | 8 bits      |
| ■ Stopbit      | 1 bit       |
| ■ Parity       | none        |
| ■ Flow control | none        |

# NOTES

---

# NOTES

---



10/23  
99-MAN 100586 v04

---

**AEMC<sup>®</sup> Instruments**  
15 Faraday Drive • Dover, NH 03820 USA  
Phone: +1 (603) 749-6434 • +1 (800) 343-1391 • Fax: +1 (603) 742-2346  
**[www.aemc.com](http://www.aemc.com)**

---

