

AC/DC Current Probes

Models

MR525 & MR526



CURRENT MEASUREMENT PROBES

Copyright© Chauvin Arnoux®, Inc. d.b.a. AEMC® Instruments. All rights reserved.

No part of this documentation may be reproduced in any form or by any means (including electronic storage and retrieval or translation into any other language) without prior agreement and written consent from Chauvin Arnoux®, Inc., as governed by United States and International copyright laws.

Chauvin Arnoux®, Inc. d.b.a. AEMC® Instruments
15 Faraday Drive • Dover, NH 03820 USA
Tel: (800) 945-2362 or (603) 749-6434 • Fax: (603) 742-2346

This documentation is provided **as is**, without warranty of any kind, express, implied, or otherwise. Chauvin Arnoux®, Inc. has made every reasonable effort to ensure that this documentation is accurate; but does not warrant the accuracy or completeness of the text, graphics, or other information contained in this documentation. Chauvin Arnoux®, Inc. shall not be liable for any damages, special, indirect, incidental, or inconsequential; including (but not limited to) physical, emotional or monetary damages due to lost revenues or lost profits that may result from the use of this documentation, whether or not the user of the documentation has been advised of the possibility of such damages.

Statement of Compliance

Chauvin Arnoux[®], Inc. d.b.a. AEMC[®] Instruments certifies that this instrument has been calibrated using standards and instruments traceable to international standards.

We guarantee that at the time of shipping your instrument has met the instrument's published specifications.

An NIST traceable certificate may be requested at the time of purchase, or obtained by returning the instrument to our repair and calibration facility, for a nominal charge.

The recommended calibration interval for this instrument is 12 months and begins on the date of receipt by the customer. For recalibration, please use our calibration services. Refer to our repair and calibration section at www.aemc.com/calibration.

Serial #: _____

Catalog #: 1200.81 / 1200.83

Model #: MR525 / MR526

Please fill in the appropriate date as indicated:

Date Received: _____

Date Calibration Due: _____



Chauvin Arnoux[®], Inc.
d.b.a AEMC[®] Instruments
www.aemc.com

TABLE OF CONTENTS

1. INTRODUCTION	6
1.1 SYMBOLS AND DEFINITIONS.....	6
1.2 DEFINITION OF MEASUREMENT CATEGORIES (CAT).....	6
1.3 PRECAUTIONS FOR USE	7
1.4 RECEIVING YOUR SHIPMENT.....	7
1.5 ORDERING INFORMATION	7
1.5.1 Accessories / Replacement Parts.....	7
2. PRODUCT FEATURES	8
2.1 DESCRIPTION	8
2.2 INTERFACE.....	9
3. OPERATION	10
3.1 BATTERY INSTALLATION	10
3.2 EXTERNAL POWER (OPTIONAL)	10
3.3 TURNING ON THE INSTRUMENT	11
3.4 AUTO STANDBY	11
3.5 DC ZERO ADJUSTMENT	11
3.6 MEASUREMENTS	12
3.6.1 Making a Measurement.....	12
3.6.2 Converting to Current	12
4. SPECIFICATIONS	13
4.1 REFERENCE CONDITIONS.....	13
4.2 ELECTRICAL SPECIFICATIONS	13
4.2.1 Electrical Specifications, 1 mV/A Sensitivity	13
4.2.2 Frequency Specifications, 1 mV/A Sensitivity.....	15
4.3 ELECTRICAL SPECIFICATIONS, 10 MV/A SENSITIVITY (MR526).....	16
4.4 OPERATING LIMITS.....	19
4.5 VARIATIONS IN THE RANGE OF USE.....	20
4.6 POWER SUPPLY	20
4.7 ENVIRONMENTAL CONDITIONS	21
4.8 MECHANICAL SPECIFICATIONS.....	22
4.8.1 Housing Protection	22
4.9 INTERNATIONAL STANDARDS.....	22
4.10 ELECTROMAGNETIC COMPATIBILITY.....	22

5. MAINTENANCE..... 23

5.1 CLEANING..... 23

5.2 BATTERY REPLACEMENT..... 23

5.3 REPAIR AND CALIBRATION 24

5.4 TECHNICAL ASSISTANCE 24











5.5 LIMITED WARRANTY..... 25

1. INTRODUCTION

Thank you for purchasing an AEMC® Instruments **AC/DC Current Probe Model MR525 or MR526**.

For the best results from your instrument and for your safety, you must read the enclosed operating instructions carefully and comply with the precautions for use. Only qualified and trained operators should use this product.

1.1 SYMBOLS AND DEFINITIONS

	WARNING , risk of DANGER! The operator must refer to these instructions whenever this symbol appears
	Refers to a Type A current sensor per IEC/EN 61010-2-032 or BS EN 61010-2-032. This symbol signifies that application around and removal from conductors carrying dangerous voltages is authorized
	Equipment is protected by double insulation
	Battery
	USB
	Useful information or tip
	Direction of the current
	The instrument follows recycling directives
	The instrument complies with US directives
	Sorting for the recycling of electric and electronic waste

1.2 DEFINITION OF MEASUREMENT CATEGORIES (CAT)

CAT IV: Corresponds to measurements performed at the primary electrical supply (< 1000 V).

Example: primary overcurrent protection devices, ripple control units, and meters.

CAT III: Corresponds to measurements performed in the building installation at the distribution level.

Example: hardwired equipment in fixed installation and circuit breakers.

CAT II: Corresponds to measurements performed on circuits directly connected to the electrical distribution system.

Example: measurements on household appliances and portable tools.

1.3 PRECAUTIONS FOR USE

These instructions are intended to ensure the safety of users and proper operation of the instrument. This instrument is compliant with the IEC 61010-2-032 or BS EN 61010-2-032 safety standards for voltages of 300 V in measurement CAT IV or 600 V in CAT III.

Failure to observe these safety instructions may result in electric shock, fire, explosion, and destruction of the instrument and installations.

- The operator and/or responsible authority must read and understand the various precautions to take when using the instrument.
- Do not use the instrument on networks that exceed the instrument's specifications for voltage or category.
- Never exceed the protection limits stated in the specifications.
- Observe the environmental conditions of use, including relative humidity, altitude, degree of pollution, and location of use.
- Do not use the instrument if it appears to be damaged, incomplete, or improperly closed.
- Before each use, check the condition of the insulation on the leads, housing, and accessories. Any component with deteriorated insulation (even partially) must be set aside for repair or scrapping.
- When handling the instrument, keep your fingers behind the physical guard.
- Use suitable personal protective equipment when appropriate.
- All troubleshooting and metrological checks must be performed by competent and accredited personnel.

1.4 RECEIVING YOUR SHIPMENT

Upon receiving your shipment, make sure that the contents are consistent with the packing list. Notify your distributor of any missing items. If the equipment appears to be damaged, file a claim immediately with the carrier, and notify your distributor at once with a detailed description of any damage. Save the damaged packing container to substantiate your claim.

1.5 ORDERING INFORMATION

AC/DC Current Probe Model MR525 **Cat. #1200.81**

Includes 9 V battery, multi-language safety data sheet, and user manual.

AC/DC Current Probe Model MR526 **Cat. #1200.83**

Includes 9 V battery, multi-language safety data sheet, and user manual.

1.5.1 Accessories / Replacement Parts

Cable – 6 ft USB type A to Micro type B **Cat. #2138.66**

Adapter – US Wall plug to USB **Cat. #2153.78**

2. PRODUCT FEATURES

2.1 DESCRIPTION

The Models MR525 and MR526 are clamp-on current probes that measure DC currents up to 1400 A, AC currents up to 1000 ARMS (1400 APEAK), and combined AC+DC currents without opening the circuit. They indicate the shape and amplitude of the current measured in the form of a voltage.

These instruments can be used with a multimeter, wattmeter, recorder, and other instruments. They can be powered by a battery or with 5 VDC via the optional micro-USB cable.

The MR525 and MR526 include the following features:

- Range overage indicator
- Power supply indicator
- Zero adjustment
- Auto Standby feature
- One or two ranges, depending on the model
 - 1 mV/A (MR525 and MR526)
 - 10 mV/A (MR526 only)
- Micro-USB connector for an external power supply

2.2 INTERFACE

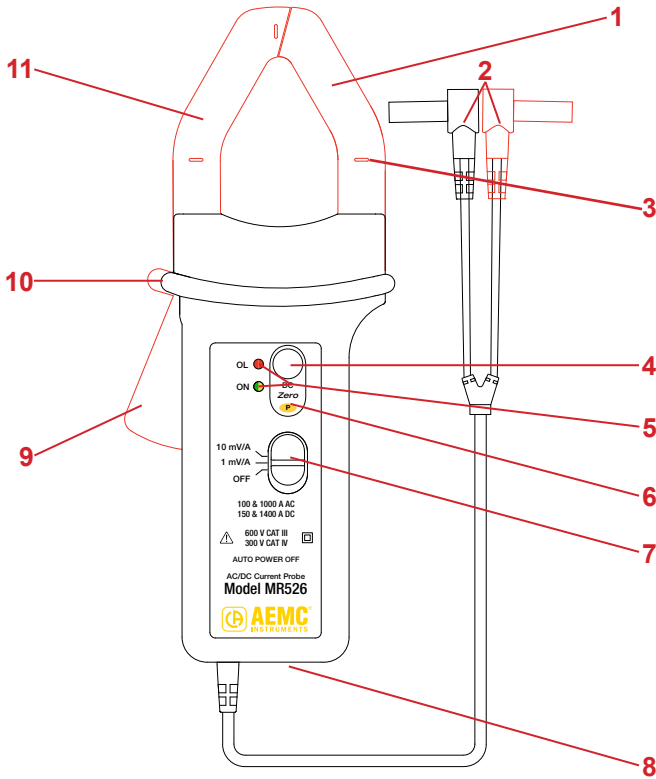

Figure 1 (MR526 shown)

Item	Function
1	Fixed jaw (does not move when the trigger is pressed)
2	Banana plugs (4 mm)
3	Arrow indicating current flow direction
4	DC Zero button
5	OL (overload) and ON indicators. ON is green when Auto Standby is enabled, and it is yellow when disabled.
6	P (Permanent mode) indicator. Hold down the DC Zero button while turning ON the instrument enables Permanent mode. In this mode, Auto Standby is disabled (see § 3.4).
7	Slide switch (2-position for MR525, 3-position for MR526)
8	USB port
9	Trigger
10	Hand guard
11	Mobile jaw (moves when the trigger is pressed)

3. OPERATION

3.1 BATTERY INSTALLATION

i **NOTE:** Before changing the batteries, set the switch to **OFF**, and remove the clamp from the circuit under measurement.

1. Using a screwdriver, remove the battery compartment cover (1) from the back of the housing (see Figure 2).
2. Connect the battery to the snap-on connector (2) while making sure that the polarity of the battery terminals match the snap-on connector.
3. Place the battery into the battery compartment (3).
4. Replace the battery compartment cover, and screw it onto the housing.

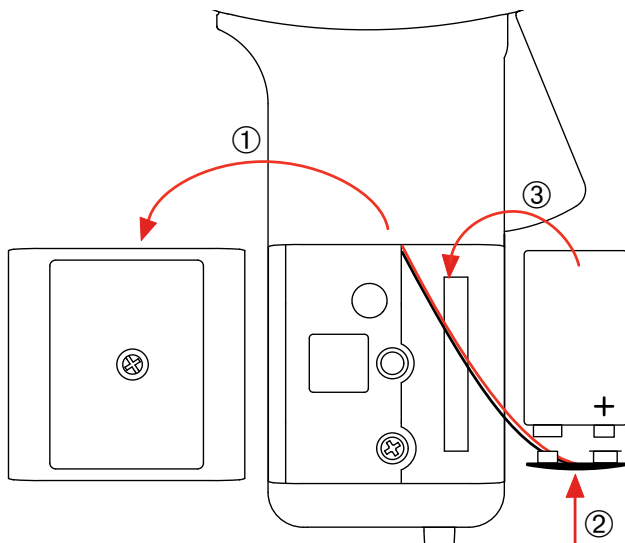

Figure 2

3.2 EXTERNAL POWER (OPTIONAL)

For long-term measurements, you can connect the clamp to external power via any micro-USB adapter that delivers 100 mA or more. If the external power is disconnected, the clamp will automatically switch to battery operation.

Between the type B micro-USB connector and the measurement output, the isolation is 600 V CAT III. This enables you to safely connect the clamp to measuring instruments with uninsulated inputs. **The type B micro-USB connector must not contact conductors or uninsulated parts at dangerous voltage.**

When operating on external power, the Auto Standby feature is disabled. The color of the ON indicator signals whether automatic standby is enabled (green) or disabled (yellow).

3.3 TURNING ON THE INSTRUMENT

Turn on the clamp by pushing the slide switch to the 1 mV/A or 10 mV/A setting:

- 1 mV/A corresponds to the 1400 A range (MR525 and MR526)
- 10 mV/A corresponds to the 150 A range (MR526)
- The green ON indicator should light up:
- If the indicator blinks, the battery has less than 4 hours remaining.
- If the indicator fails to light up, replace the battery (see § 5.2).

3.4 AUTO STANDBY

After 10 minutes of operation without any user action (such as pressing the DC Zero button), the clamp will automatically enter Auto Standby mode. In this mode, the ON indicator will turn OFF.

To reactivate the clamp, press the DC Zero button, or change the switch to any setting other than OFF.

To disable automatic standby, press and hold the DC Zero when turning the instrument ON. The ON indicator will blink to indicate that the request has been applied. When you release the DC Zero button, the indicator will glow steady yellow.

3.5 DC ZERO ADJUSTMENT



NOTE: You must adjust the DC Zero before a series of measurements and whenever the instrument reconnects after a disconnection.

- With the clamp connected to the measuring instrument, select the desired measurement range (or sensitivity) with the switch.
- Make sure that there is no conductor in the clamp and that the jaws are closed correctly.
- Press the DC Zero button.
- The OL indicator will light up for approximately three seconds to indicate that the zero adjustment is in progress.
- The OL indicator will turn off to indicate that the operation has succeeded.
- If the OL indicator stays on, the zero could not be adjusted.
- Before repeating the operation, check that the jaws are closed correctly (air gaps clean, no dust, no oxidation, etc.) and that there is no conductor in the clamp.
- Press the DC Zero button again.
- In the event of failure, or if the clamp is switched off (selector set to OFF), the instrument keeps the last successful DC Zero adjustment.



WARNING: If the measurement range (or sensitivity) is changed, the DC Zero must be adjusted before any further measurements are made.

3.6 MEASUREMENTS

3.6.1 Making a Measurement

After adjusting the DC Zero:

1. Press the clamp's trigger to open the jaws.
2. Clamp the jaws around the conductor to be measured. Use the centering marks on the jaws to position the clamp around the conductor. If the measurement is for a power calculation, ensure that the arrow on the clamp jaws (see Figure 3) points in the direction of the current flow:

source \Rightarrow load

3. Release the trigger while ensuring that the jaws are completely and correctly closed.
4. Observe the measurement displayed on the instrument.
5. If the OL indicator turns on, the current is too high to be measured. If you are using the MR526 and the sliding switch is set to the 10 mV/A range, change the setting to 1 mV/A.

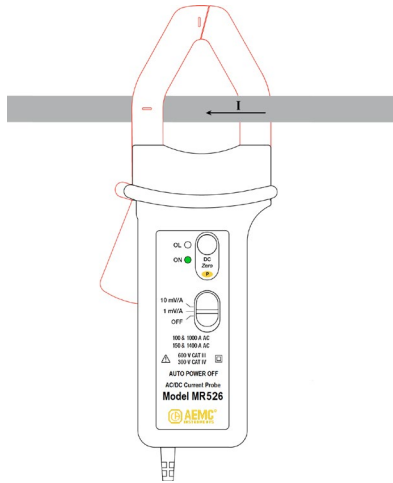

Figure 3 (MR526 shown)

3.6.2 Converting to Current

Both models can measure current up to 1400 A with 1 mV corresponding to 1 A. In addition, the MR526 provides a second measurement range up to 150 A with 10 mV corresponding to 1 A.

To convert the clamp output to current, divide the voltage reading on the connected measuring instrument by the V/A coefficient.

$$\frac{\text{Reading (mV)}}{\text{Range (mV/A)}} = \text{Current (A)}$$

1400 A Range (1 mV): $\frac{100 \text{ mV}}{1 \text{ mV/A}} = 100 \text{ A}$

150 A Range (10 mV): $\frac{100 \text{ mV}}{10 \text{ mV/A}} = 10 \text{ A}$

4. SPECIFICATIONS

4.1 REFERENCE CONDITIONS

Quantities of Influence	Reference Conditions
Temperature	73 °F ± 9 °F (23 °C ± 5 °C)
Relative humidity	(20 to 75) % RH
Position of the conductor	Centered on the marks of the jaws
Measurement frequency	DC to 65 Hz sine wave
External electrical field	Zero
External DC magnetic field (earth)	<40 A/m
External AC magnetic field	Zero
Input impedance	≥1 MΩ and ≤100 pF

The intrinsic uncertainty is the error defined under the reference conditions. It is expressed as a percentage of the output signal (R) plus an offset in mV: $\pm(a \% R + b)$

4.2 ELECTRICAL SPECIFICATIONS

4.2.1 Electrical Specifications, 1 mV/A Sensitivity

Output impedance: 215 Ω

Specified Measurement Range	(0.5 to 100) AAC/DC	(100 to 800) AAC/DC	(800 to 1000) AAC/DC	(1000 to 1400) ADC
Intrinsic uncertainty	$\leq \pm(2 \% R + 1.5 \text{ mV})$	$\leq \pm 2.5 \% R$	$\leq \pm 4 \% R$	$\leq \pm 5 \% R$

Phase error (45 to 65) Hz

Specified Measurement Range	(3 to 200) AAC	(200 to 1000) AAC
Phase shift	$\leq -2^\circ$	$\leq -1.5^\circ$

Typical amplitude error curve at 60 Hz

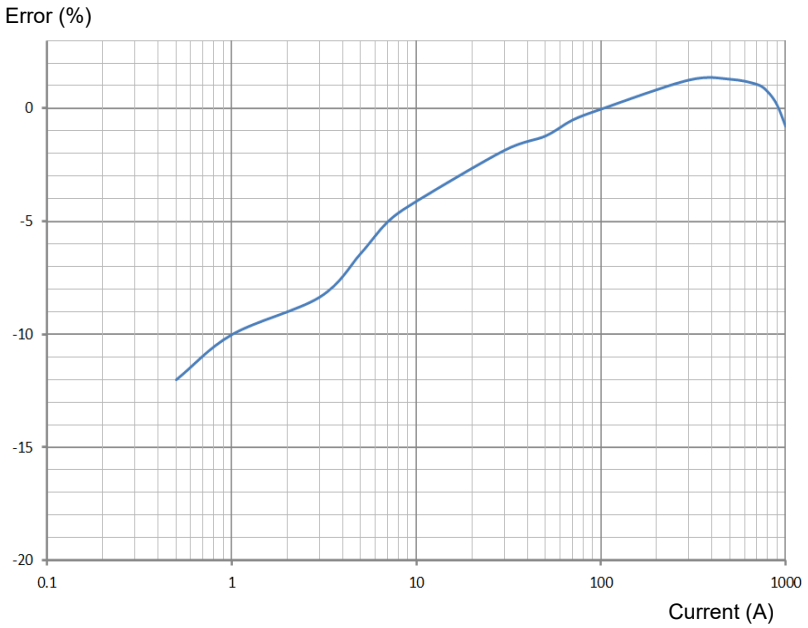

Typical amplitude error curve in DC

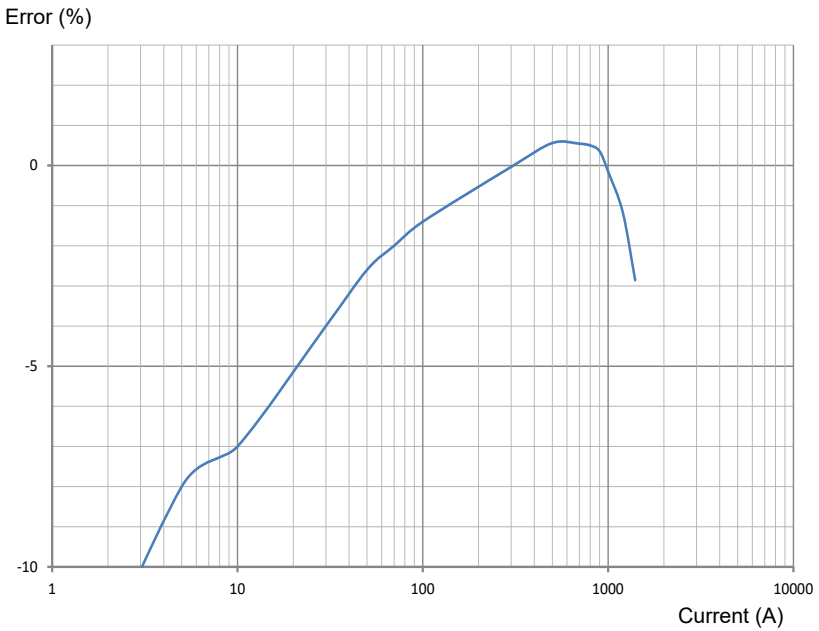

Typical phase error curve at 60 Hz

Phase shift (°)

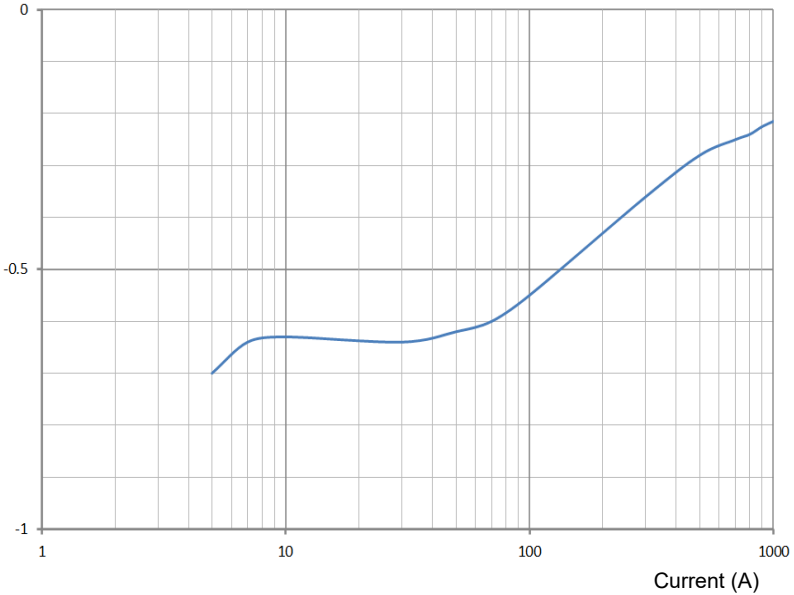

4.2.2 Frequency Specifications, 1 mV/A Sensitivity

Bandwidth -3 dB: DC to 30 kHz

Frequency	50 Hz	400 Hz	1 kHz	10 kHz
Insertion impedance	<0.01 mΩ	0.05 mΩ	0.14 mΩ	3.4 mΩ

Typical amplitude error versus frequency curve at 60 A

Error (%)

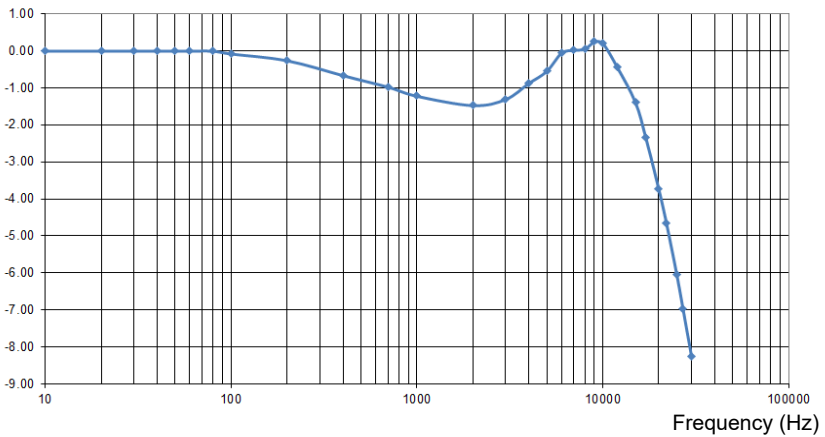

Typical phase versus frequency error curve at 60 A

Phase shift (°)

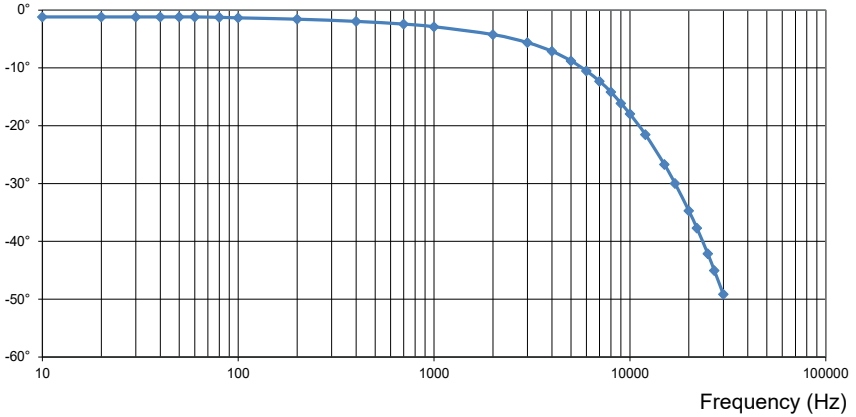

4.3 ELECTRICAL SPECIFICATIONS, 10 mV/A SENSITIVITY (MR526)

Output impedance: 215 Ω

Specified Measurement Range	(0.5 to 40) AAC/DC	(40 to 100) AAC/DC	(100 to 150) ADC
Intrinsic uncertainty	≤ ±(3 % R + 8 mV)	≤ ±1.5 % R	≤ ±1.5 % R

Phase error (45 to 65 Hz)

Specified Measurement Range	(1 to 100) AAC
Phase shift	≤ -2 °

Typical amplitude error vs current curve at 60 Hz

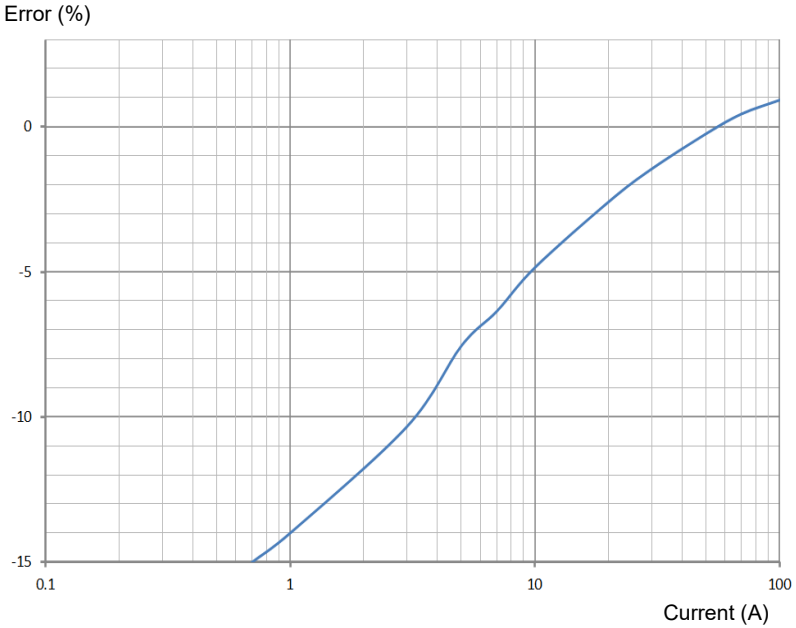

Typical amplitude error vs current curve in DC

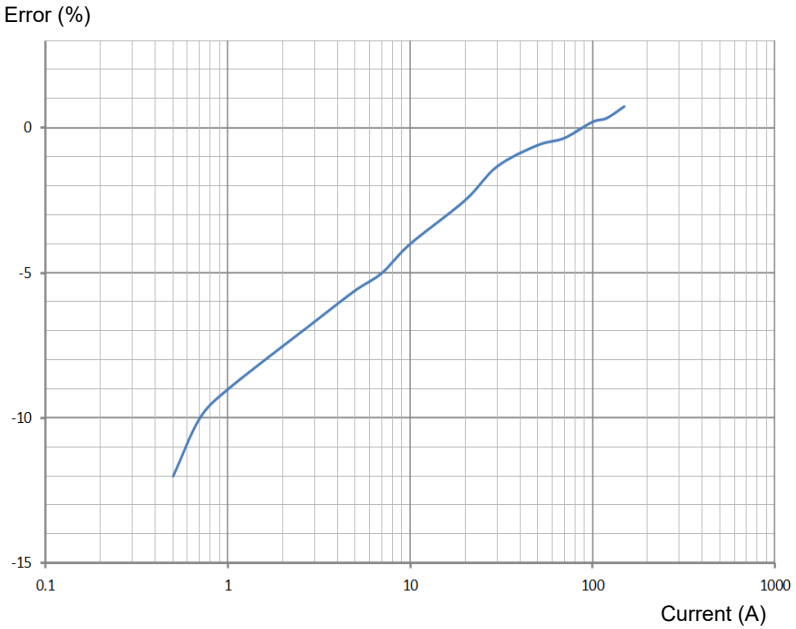

Typical phase vs current error curve at 60 Hz

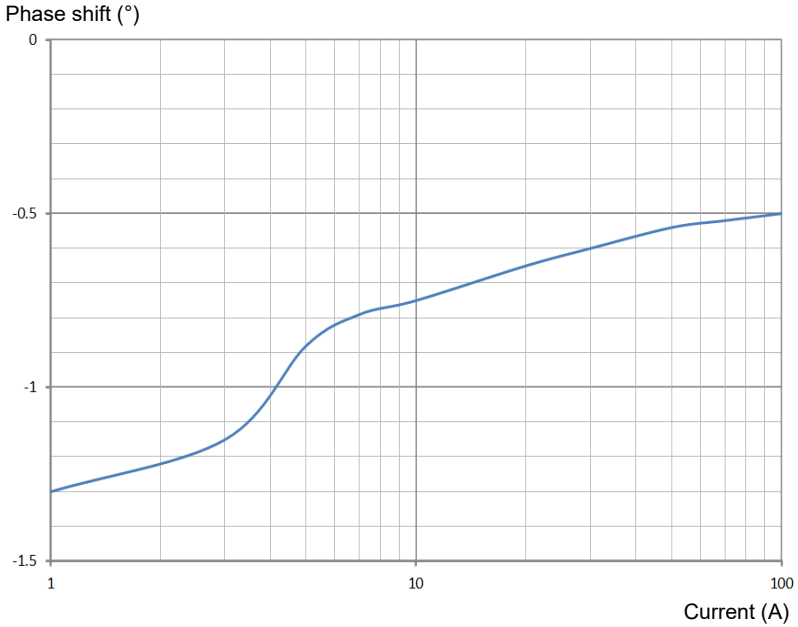

Frequency Specifications, 10 mV/A Sensitivity

Bandwidth -3 dB: DC to 30 kHz

Frequency	50 Hz	400 Hz	1 kHz	10 kHz
Insertion impedance	<0.01 mΩ	0.05 mΩ	0.14 mΩ	3.4 mΩ

Typical amplitude error versus frequency curve at 30 A

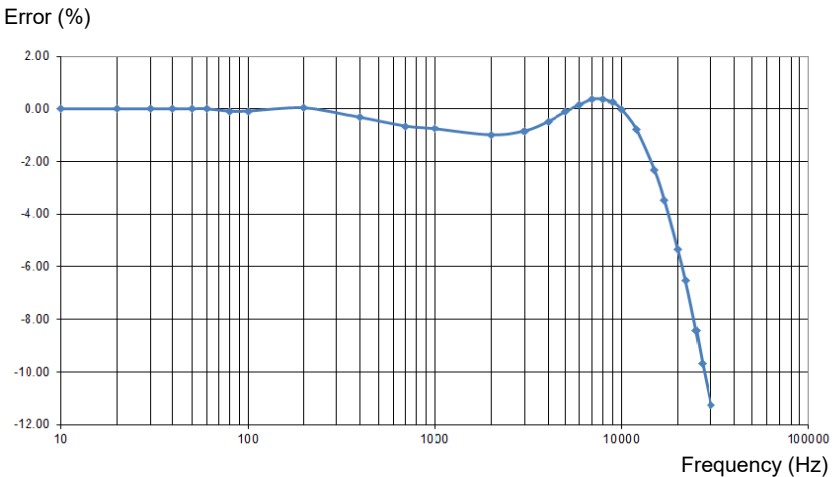

Typical phase versus frequency error curve at 30 A

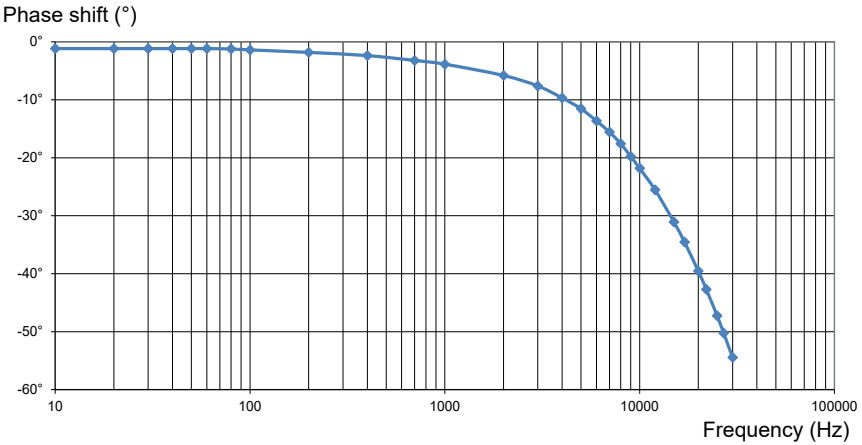

4.4 OPERATING LIMITS

- In DC: 3000 A permanent
- In AC: 1000 A permanent up to 1 kHz
from 1 kHz, $I_{MAX} = 1000/f$ (kHz)
- Conductor temperature: ≤ 194 °F, 230 °F peak (90 °C, 110 °C peak)
- Temperature of the jaws: ≤ 176 °F (80 °C)

Curve of derating versus frequency

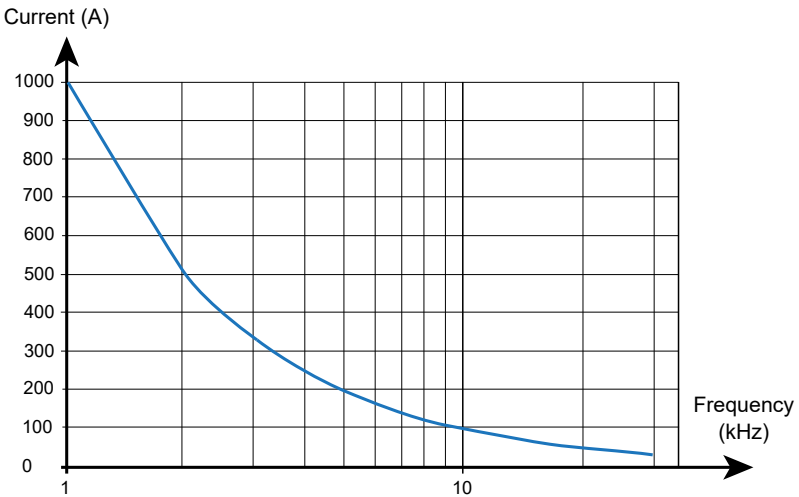

4.5 VARIATIONS IN THE RANGE OF USE

Quantity of influence	Range of influence	Error in % of reading	
		Typical	Maximum
Temperature	(14 to 131) °F (-10 to +55) °C		Drift of the zero ±55.56 mA/°F (±100 mA/°C)
			Drift of the gain 3 %
Relative humidity	(10 to 85) % RH		0.5 %
Frequency	from (10 to 400) Hz from 400 Hz to 7 kHz from (7 to 30) kHz		1 % 3.5 % see curves
Position of the conductor 20 mm in diameter			0.5 %
Adjacent conductor carrying a 50 Hz AC current	Conductor 23 mm from the clamp		10 mA/A
External 400 A/m field at 50 Hz	Cable centered		1.3 A
Common mode rejection	600 V between the jacket and the secondary		90 dB A/V at 50 Hz
Remanence		100 Adc: 2.8 A 200 Adc: 3.5 A 400 Adc: 5 A 800 Adc: 5.3 A 1200 Adc: 5.7 A 1400 Adc: 5.8 A	

4.6 POWER SUPPLY

The instrument is powered by a 9 V battery (type 6LR61, 6LF22, or NEDA 1604). The average battery life is 50 hours with an alkaline battery.

The instrument can also be powered by an external supply (5 Vdc, 100 mA) via the type B micro-USB connector.

4.7 ENVIRONMENTAL CONDITIONS

The instrument must be used in the following environmental conditions.

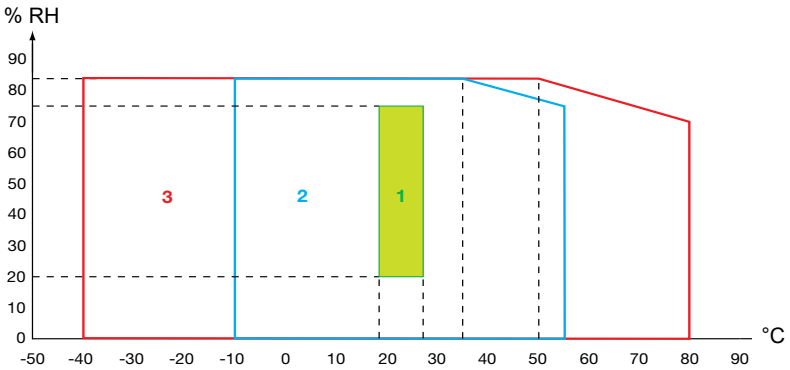

1 = Range of reference

2 = Operating range

3 = Storage range

Indoor use

Degree of pollution: 2

Altitude: <6500 ft (2000 m)

Transport altitude: ≤40,000 ft (12,000 m)

4.8 MECHANICAL SPECIFICATIONS

Dimensions (L x W x H): 9.3 x 3.8 x 1.7 in (237 x 97 x 44 mm)

Weight: 18.3 oz (520 g)

Cable: 4.9 ft (1.50 m)

Maximum Conductor Size:

Cables: One 1.54 in (39 mm) or two 1 in (25.4 mm)

Bus Bar: One 1.97 x 0.49 in (50 x 12.5 mm); two 0.98 x 0.2 in (50 x 5 mm); two 1.24 x 0.30 in (31.5 x 10 mm); or three 0.98 x 0.31 in (25 x 8 mm)

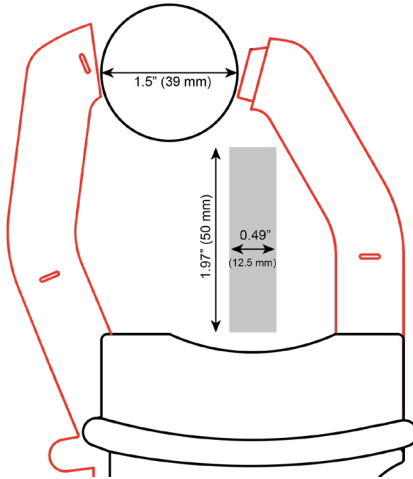

Figure 4

4.8.1 Housing Protection

Protection index:

- IP 40 per IEC 60529
- IK 06 per IEC 62262

Drop test per IEC/EN 61010-2-032 or BS EN 61010-2-032

4.9 INTERNATIONAL STANDARDS

The instrument is compliant with IEC/EN 61010-2-032 or BS EN 61010-2-032, 300 V in CAT IV or 600 V in CAT III.

Double or reinforced insulation 

Type of current sensor per IEC/EN 61010-2-032 or BS EN 61326-1:  (type A)

4.10 ELECTROMAGNETIC COMPATIBILITY

The device is in conformity with standard IEC/EN 61326-1 or BS EN 61326-1.

5. MAINTENANCE



WARNING: Except for the battery, the instrument contains no parts that can be replaced by personnel who have not been specially trained and accredited. Any unauthorized repair or replacement of a part by an **equivalent** may gravely impair safety.

5.1 CLEANING

- Disconnect anything connected to the clamp.
- Use a soft cloth, dampened with soapy water.
- Rinse with a damp cloth and dry rapidly with a dry cloth or forced air.
- Do not use alcohol, solvents, or hydrocarbons.
- Keep the clamp jaws as clean as possible.

5.2 BATTERY REPLACEMENT

The battery must be replaced if the ON indicator remains unlit when the instrument is turned ON.

- Disconnect the instrument completely and set the switch to OFF.
- Remove the battery compartment cover from the instrument casing (see § 3.1).
- Remove the old battery.
- Insert the replacement battery into the snap-in battery connector, and place it into the battery compartment.
- Replace the battery compartment cover.



NOTE: Depleted batteries must not be treated as ordinary household waste. Take them to the appropriate collection point for recycling.

5.3 REPAIR AND CALIBRATION

To ensure that your instrument meets factory specifications, we recommend that the instrument be sent back to our factory Service Center at one-year intervals for recalibration or as required by other standards or internal procedures.

For instrument repair and calibration:

You must contact our Service Center for a Customer Service Authorization Number (CSA#). Send an email to repair@aemc.com requesting a CSA#, you will be provided a CSA Form and other required paperwork along with the next steps to complete the request. Then return the instrument along with the signed CSA Form. This will ensure that when your instrument arrives, it will be tracked and processed promptly. Please write the CSA# on the outside of the shipping container. If the instrument is returned for calibration, we need to know if you want a standard calibration or a calibration traceable to N.I.S.T. (includes calibration certificate plus recorded calibration data).

Ship To: Chauvin Arnoux®, Inc. d.b.a. AEMC® Instruments
15 Faraday Drive • Dover, NH 03820 USA
Phone: (800) 945-2362 (Ext. 360) / (603) 749-6434 (Ext. 360)
Fax: (603) 742-2346
E-mail: repair@aemc.com

(Or contact your authorized distributor.)

Contact us for the costs for repair, standard calibration, and calibration traceable to N.I.S.T.



NOTE: You must obtain a CSA# before returning any instrument.

5.4 TECHNICAL ASSISTANCE

If you are experiencing any technical problems or require any assistance with the proper operation or application of your instrument, please call, e-mail or fax our technical support team:

Chauvin Arnoux®, Inc. d.b.a. AEMC® Instruments
Phone: (800) 343-1391 (Ext. 351)
Fax: (603) 742-2346
E-mail: techsupport@aemc.com
www.aemc.com

5.5 LIMITED WARRANTY

The instrument is warranted to the owner for a period of two years from the date of original purchase against defects in manufacture. This limited warranty is given by AEMC® Instruments, not by the distributor from whom it was purchased. This warranty is void if the unit has been tampered with, abused, or if the defect is related to service not performed by AEMC® Instruments.

Full warranty coverage and product registration is available on our website at www.aemc.com/warranty.html.

Please print the online Warranty Coverage Information for your records.

What AEMC® Instruments will do:

If a malfunction occurs within the warranty period, you may return the instrument to us for repair, provided we have your warranty registration information on file or a proof of purchase. AEMC® Instruments will repair or replace the faulty material at our discretion.

REGISTER ONLINE AT: www.aemc.com/warranty.html

5.5.1 Warranty Repairs

What you must do to return an Instrument for Warranty Repair:

First, send an email to repair@aemc.com requesting a Customer Service Authorization Number (CSA#) from our Service Department. You will be provided a CSA Form and other required paperwork along with the next steps to complete the request. Then return the instrument along with the signed CSA Form. Please write the CSA# on the outside of the shipping container. Return the instrument, postage or shipment pre-paid to:

Chauvin Arnoux®, Inc. d.b.a. AEMC® Instruments
15 Faraday Drive, Dover, NH 03820 USA
Phone: (800) 945-2362 (Ext. 360)
(603) 749-6434 (Ext. 360)
Fax: (603) 742-2346
E-mail: repair@aemc.com

Caution: To protect yourself against in-transit loss, we recommend that you insure your returned material.



NOTE: You must obtain a CSA# before returning any instrument.

NOTES:

NOTES:



08/24
99-MAN 100523 v06

AEMC[®] Instruments
15 Faraday Drive • Dover, NH 03820 USA
Phone: +1 (603) 749-6434 • +1 (800) 343-1391 • Fax: +1 (603) 742-2346
www.aemc.com
