

110/113/114/115/117

True-rms Multimeter

Users Manual

March 2020

© 2020 Fluke Corporation. All rights reserved. Specifications are subject to change without notice.
All product names are trademarks of their respective companies.

LIMITED WARRANTY AND LIMITATION OF LIABILITY

This Fluke product will be free from defects in material and workmanship for three years from the date of purchase. This warranty does not cover fuses, disposable batteries, or damage from accident, neglect, misuse, alteration, contamination, or abnormal conditions of operation or handling. Resellers are not authorized to extend any other warranty on Fluke's behalf. To obtain service during the warranty period, contact your nearest Fluke authorized service center to obtain return authorization information, then send the product to that Service Center with a description of the problem.

THIS WARRANTY IS YOUR ONLY REMEDY. NO OTHER WARRANTIES, SUCH AS FITNESS FOR A PARTICULAR PURPOSE, ARE EXPRESSED OR IMPLIED. FLUKE IS NOT LIABLE FOR ANY SPECIAL, INDIRECT, INCIDENTAL OR CONSEQUENTIAL DAMAGES OR LOSSES, ARISING FROM ANY CAUSE OR THEORY. Since some states or countries do not allow the exclusion or limitation of an implied warranty or of incidental or consequential damages, this limitation of liability may not apply to you.vision.

Fluke Corporation
P.O. Box 9090
Everett, WA 98206-9090
U.S.A.

Fluke Europe B.V.
P.O. Box 1186
5602 BD Eindhoven
The Netherlands

ООО «Флюк СИИЙЭС»
125167, г. Москва,
Ленинградский проспект дом 37,
корпус 9, подъезд 4, 1 этаж

Table of Contents

Title	Page
Introduction	1
How to Contact Fluke.....	1
Safety Information.....	1
Unsafe Voltage	1
Test Lead Alert.....	1
Product Familiarization	2
Features.....	2
Display	3
Terminals	4
Error Messages	5
Battery Saver™ (Sleep Mode).....	5
MIN MAX AVG Recording Mode	5
Display HOLD	6
Backlight	6
Manual and Autoranging.....	6
Power-Up Options	6
Making Basic Measurements.....	7
Measuring Resistance	7
Testing for Continuity.....	7
Measuring AC and DC Voltage	8
Using Auto Volts Selection (114, 117).....	8
Measuring AC and DC Millivolts (110, 114, 115, 117).....	8
Measuring AC or DC Current (115, 117).....	9
Measuring Current above 10 Amps (110, 114, 115, 117)	9
Measuring Capacitance (113, 115, 117)	10
Measuring Frequency (115, 117)	10
Detecting AC Voltage Presence (117).....	11
Making Low Impedance Capacitance Measurements (115, 117)	11
Testing Diodes (113, 115, 117)	12
Using the Bargraph.....	12
Maintenance	13
Testing the Fuse (115, 117).....	13
Replacing the Battery and Fuse	13
Cleaning.....	14
Specifications.....	15

Introduction

The Fluke Model 110, Model 113, Model 114, Model 115, and Model 117 (the Meter or Product) are battery-powered, true-rms multimeters with a 6000-count display and a bar graph. This manual applies to all models. All figures show the Model 117 unless indicated.

How to Contact Fluke

To contact Fluke, call one of the following telephone numbers:

- Technical Support USA: 1-800-44-FLUKE (1-800-443-5853)
- Calibration/Repair USA: 1-888-99-FLUKE (1-888-993-5853)
- Canada: 1-800-36-FLUKE (1-800-363-5853)
- Europe: +31 402-675-200
- Japan: +81-3-6714-3114
- Singapore: +65-6799-5566
- China: +86-400-921-0835
- Brazil: +55-11-3530-8901
- Anywhere in the world: +1-425-446-5500

Or, visit Fluke's website at www.fluke.com.

To register your product, visit <http://register.fluke.com>.

To view, print, or download the latest manual supplement, visit <http://us.fluke.com/usen/support/manuals>.

To request a printed manual, visit www.fluke.com/productinfo.

Safety Information

For Product safety information, see the printed *110/113/114/115/117 Safety Information* included with the Product or located on the Fluke website.

Unsafe Voltage

To alert you to the presence of a potentially hazardous voltage, the ζ symbol is displayed when the Meter measures a voltage ≥ 30 V or a voltage overload (**OL**) condition. When making frequency measurements >1 kHz, the ζ symbol is unspecified.

Test Lead Alert

Warning

Personal injury or damage to the Meter can occur if you attempt to make a measurement with a lead in an incorrect terminal.

To remind you to check that the test leads are in the correct terminals, **LEAD** is briefly displayed and an audible beep sounds when you move the rotary switch to or from any **A** (Amps) position.

Product Familiarization

The manual explains features for multiple models. Because models have different features, not all of the information in the manual may apply to your Meter. Use Table 1 to identify the features of your Meter.

Features

Table 1 is a list of the features for each Meter.

Table 1. Features

Switch Position	Measurement Function	110	113	114	115	117
OFF	The Meter is turned off.	●	●	●	●	●
AUTO-V LoZ	Automatically selects ac or dc volts based on the sensed input with a low impedance input.			●		●
\sim Hz V	AC voltage from 0.06 V to 600 V. Frequency from 5 Hz to 100 kHz.	●		●	●	●
$\overline{\text{V}}$	DC voltage from 0.001 V to 600 V.	●		●	●	●
\sim mV $\overline{\text{---}}$	AC voltage from 6.0 to 600 mV, dc-coupled. DC voltage from 0.1 to 600 mV.	●		●	●	●
Ω	Ohms from 0.1 Ω to 40 M Ω .	●	●	●	●	●
 	Continuity beeper turns on at <20 Ω and turns off at >250 Ω .	●	●	●	●	●
V CHEK	LoZ low impedance measurement function to simultaneously test for voltage or continuity.		●			
\rightarrow	Diode Test. Displays OL above 2.0 V.		●		●	●
\leftarrow	Farads from 1 nF to 9999 μ F.		●		●	●
\sim A _{Hz}	AC current from 0.1 A to 10 A (>10 to 20 A, 30 seconds on, 10 minutes off). >10.00 A display flashes. >20 A, OL is displayed. DC-coupled. Frequency from 45 Hz to 5 kHz.				●	●
$\overline{\text{A}}$	DC current from 0.001 A to 10 A (>10 A to 20 A, 30 seconds on, 10 minutes off). >10.00 A display flashes. >20 A, OL is displayed.				●	●
Volt Alert	Non-contact sensing of ac voltage.					●
<p>Note: All ac functions and Auto-V LoZ are true-rms. AC voltage is ac-coupled. Auto-V LoZ, AC mV and AC amps are dc-coupled.</p>						

Display

Table 2 is a list of the features for each display.

Table 2. Display

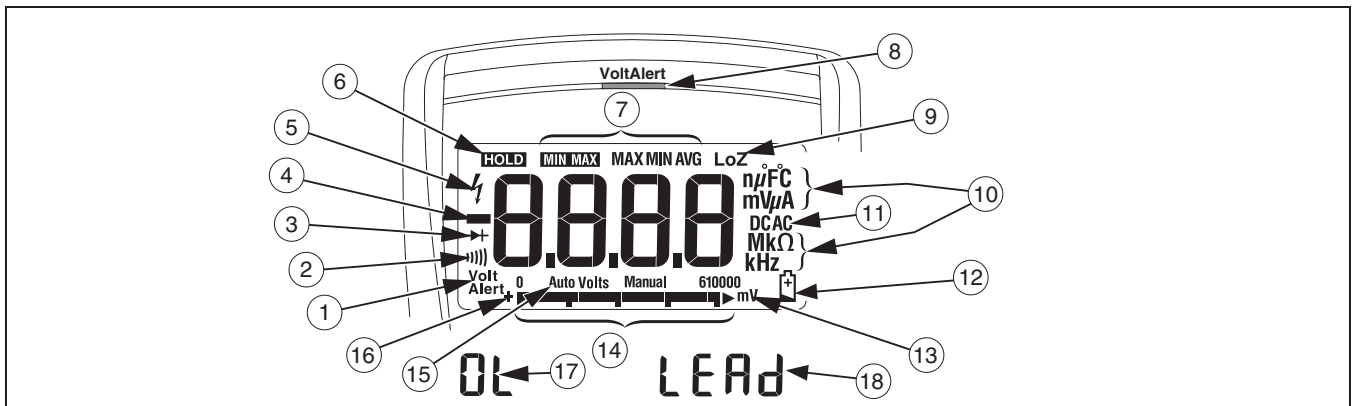

No.	Symbol	Meaning	Model
①	Volt Alert	The Meter is in the VoltAlert™ non-contact voltage detect mode.	117
②)	The Meter function is set to Continuity.	110, 113, 114, 115, 117
③	→	The Meter function is set to Diode Test	113, 115, 117
④	-	Input is a negative value.	110, 113, 114, 115, 117
⑤	⚡	⚠ Unsafe voltage. Measured input voltage ≥ 30 V, or voltage overload condition (OL).	110, 113, 114, 115, 117
⑥	HOLD	Display hold enabled. Display freezes present reading.	110, 113, 114, 115, 117
⑦	MIN MAX MAX MIN AVG	MIN MAX AVG mode enabled. Maximum, minimum, average or present reading displays	110, 113, 114, 115, 117
⑧	(Red LED)	Voltage presence through the non-contact VoltAlert sensor	117
⑨	LoZ	The Meter is measuring voltage or capacitance with a low input impedance.	113, 114, 115, 117
⑩	nF mV uA MkΩ kHz	Measurement units.	110, 114, 115, 117
⑪	DC AC	Direct current or alternating current	110, 113, 114, 115, 117
⑫	🔋	Battery low warning.	110, 113, 114, 115, 117
⑬	610000 mV	Indicates the Meter's range selection.	110, 114, 115, 117
⑭	(Bar graph)	Analog display.	110, 113, 114, 115, 117

Table 2. Display (cont.)

No.	Symbol	Meaning	Model
⑮	Auto Volts	The Meter is in the Auto Volts function.	114, 117
	Auto	Autoranging. The Meter selects the range for best resolution.	110, 113, 114, 115, 117
	Manual	Manual ranging. User sets the Meter's range.	110, 113, 114, 115, 117
⑯	+	Bar graph polarity	110, 113, 114, 115, 117
⑰		The input is too large for the selected range.	110, 113, 114, 115, 117
⑱	LEAD	Test lead alert. Briefly displayed whenever the Meter's function switch is rotated to or from any A position.	115, 117

Terminals

Table 3 is a list of terminals on the Meter.

Table 3. Terminals

No.	Description	Model
①	Input terminal for measuring ac and dc current to 10 A.	115, 117
②	Common (return) terminal for all measurements.	110, 113, 114, 115, 117
③	Input terminal for measuring voltage, continuity, resistance, capacitance, frequency and testing diodes.	110, 113, 114, 115, 117

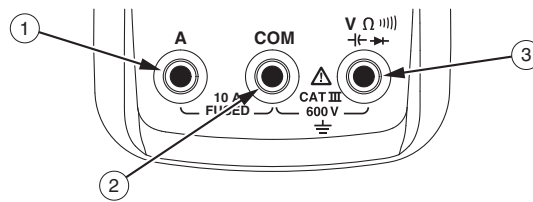

Error Messages

Table 4 is a list of error messages for the Meter.

Table 4. Error Messages

Error Messages	
bAtt	Battery must be replaced before the Meter will operate.
Cal Err	Calibration required. Meter calibration is required before the Meter will operate.
EEP Err	Internal error. The Meter must be repaired before it will operate.
Flt Err	Internal error. The Meter must be repaired before it will operate.

Battery Saver™ (Sleep Mode)

If the Meter is ON, but inactive and not connected to voltage for more than 20 minutes, the display goes blank to save battery life. To use the Meter, press any button or turn the rotary switch. To disable the Sleep mode, see [Power-Up Options](#). The Sleep mode is always disabled in the MIN MAX AVG mode.

MIN MAX AVG Recording Mode

The MIN MAX AVG recording mode captures the minimum and maximum input values (ignoring overloads), and calculates a running average of all readings. When the Meter detects a new high or low, the Meter beeps.

Note

Autoranging and Battery Saver™ are disabled in MIN MAX AVG mode.



1. Select the measurement function and range.
2. Push **MIN MAX** to enter MIN MAX AVG mode.
MIN MAX and MAX show on the display. The highest reading detected since entering MIN MAX AVG shows on the display.
3. Push **MIN MAX** to step through the low (MIN), average (AVG), and present readings.
4. To pause MIN MAX AVG recording without erasing stored values, push **HOLD**. (**HOLD** shows on the display.)
5. To resume MIN MAX AVG recording, push **HOLD** again.
6. To exit and erase stored readings, push **MIN MAX** for at least one second, or turn the rotary switch.

Display HOLD

Warning

To avoid electric shock, when Display HOLD is activated, be aware that the display will not change when you apply a different voltage.

In the Display HOLD mode, the Meter freezes the display.

1. Push  to activate Display HOLD. (**HOLD** shows on the display.)
2. To exit and return to normal operation, push  or turn the rotary switch.



Backlight

Push  to toggle the backlight on and off.

The backlight automatically turns off after 40 seconds. To disable backlight auto-off, see [Power-Up Options](#).

Manual and Autoranging

The Meter has both Manual and Autorange modes. The Meter defaults to Autorange. To toggle between Manual and Autorange, push  for 1 second.

- In the Autorange mode, the Meter selects the range with the best resolution.
- In the Manual Range mode, you override Autorange and select the range yourself. Push  for 1 second to enter Manual range. (**Manual** shows on the display.) Push  to increment the range. After the highest range, the Meter wraps to the lowest range.





Note

You cannot manually change the range in the MIN MAX AVG or Display HOLD modes. If you push  while in MIN MAX AVG or Display Hold, the Meter beeps twice, indicating an invalid operation and the range does not change.

Power-Up Options

To select a Power-Up Option, hold down the button indicated in Table 5 while turning the Meter from OFF to any other function. Power-Up Options are canceled when you turn off the Meter and when sleep mode is activated.

Table 5. Power-Up Options

Button	Power-Up Options
	Turns on all display segments until button is released.
	Disables beeper. bEEP shows when enabled.
	113 - Turns on all display segments until button is released.
	115, 117 - Enables low impedance capacitance measurements. LCAP shows when enabled.
	Disables Battery Saver™ (Sleep mode). Poff shows when enabled.
	Disables auto backlight off. Loff is displayed when enabled.

Making Basic Measurements

When connecting the test leads to the circuit or device, connect the common (**COM**) test lead before connecting the live lead; when removing the test leads, remove the live lead before removing the common test lead.

⚠⚠ Warning

To avoid electric shock, injury, or damage to the Meter, disconnect circuit power and discharge all high-voltage capacitors before testing resistance, continuity, diodes, or capacitance.

Measuring Resistance

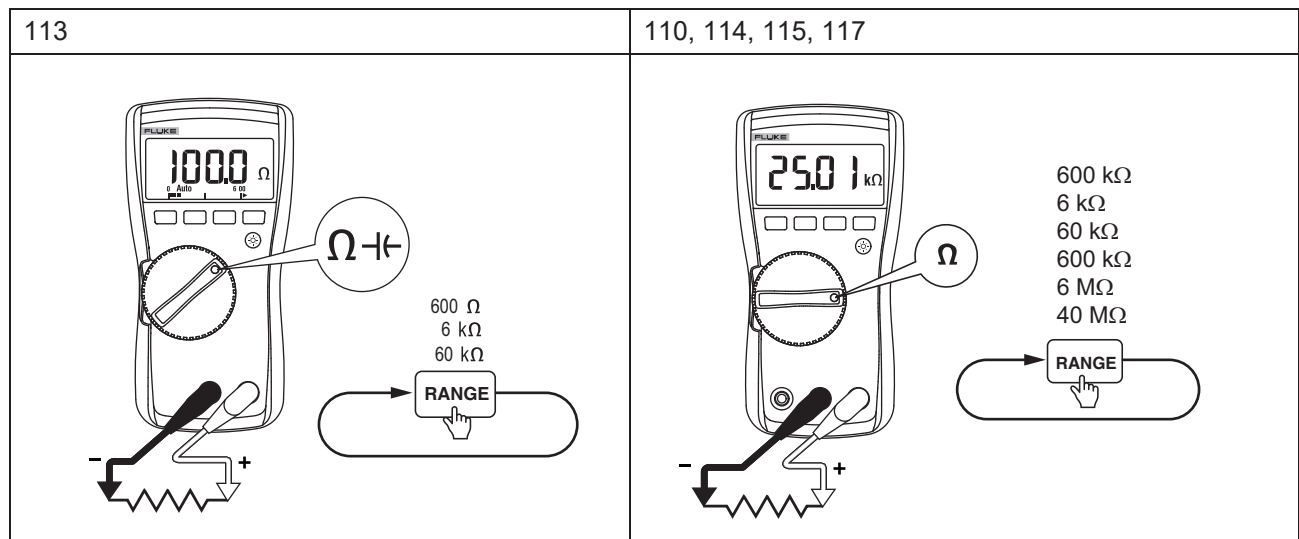

Testing for Continuity

Note

Use the continuity function as a fast, convenient method to check for opens and shorts. For maximum accuracy in making resistance measurements, use the Meter's resistance (Ω) function.

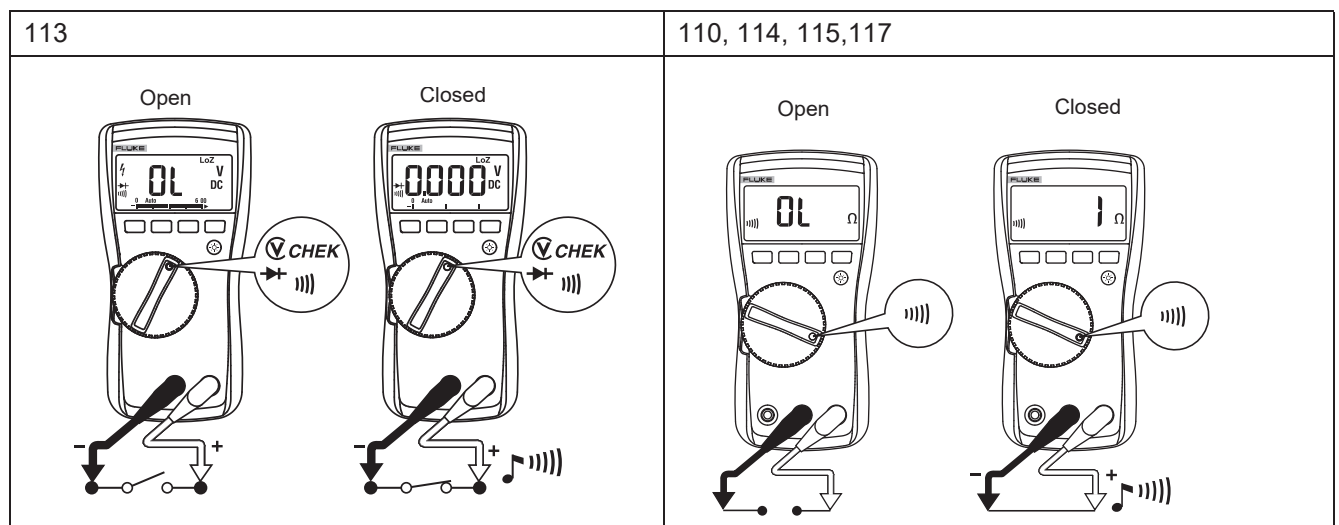

Measuring AC and DC Voltage

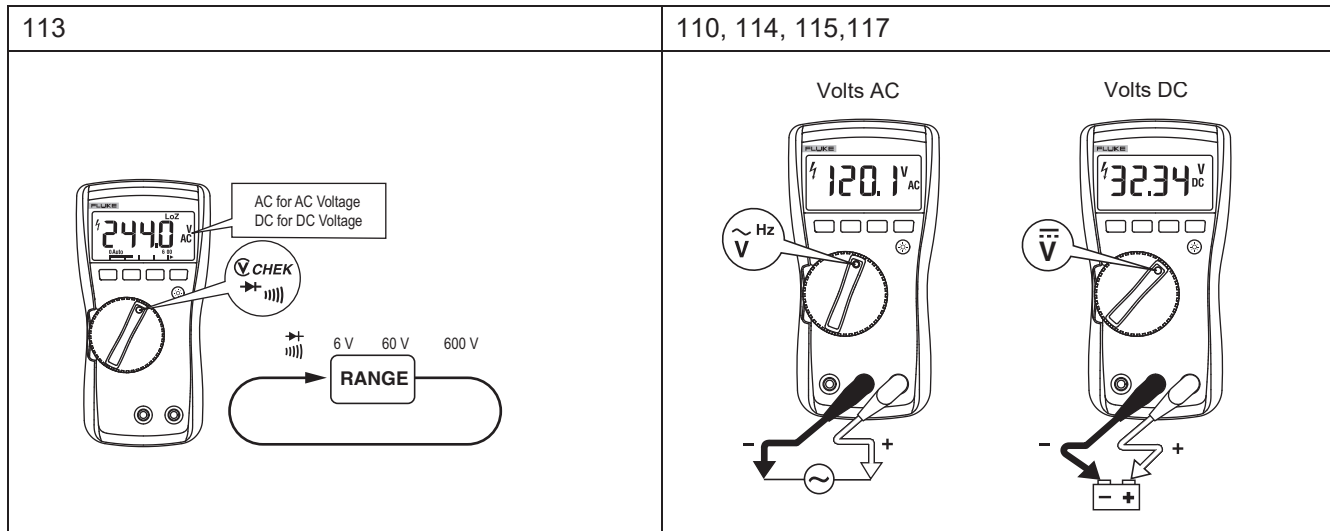

Using Auto Volts Selection (114, 117)

With the function switch in the $\overset{\text{AUTO-V}}{\text{LoZ}}$ position, the Meter automatically selects a dc or ac voltage measurement based on the input applied between the **V** or **+** and **COM** jacks.

This function also sets the Meter's input impedance to approximately 3 k Ω to reduce the possibility of false readings due to ghost voltages.

Measuring AC and DC Millivolts (110, 114, 115, 117)

With the function switch in the $\overset{\sim}{\text{mV}}$ position, the Meter measures ac plus dc millivolts. Press to set the Meter to dc millivolts.

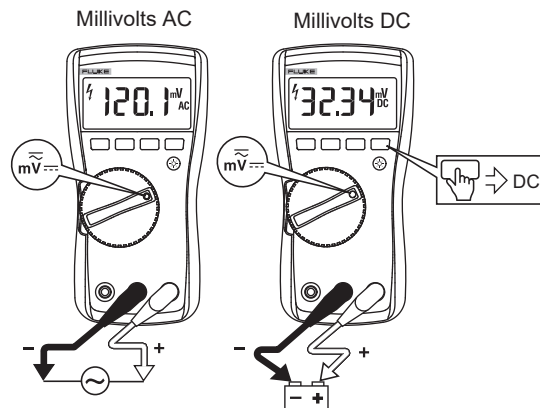

Measuring AC or DC Current (115, 117)

⚠⚠ Warning

To avoid personal injury or damage to the Meter:

- Never attempt to make an in-circuit current measurement when the open-circuit potential to earth is >600 V.
- Check the Meter's fuse before testing. See [Testing the Fuse \(115, 117\)](#).
- Use the proper terminals, switch position, and range for your measurement.
- Never place the probes in parallel with a circuit or component when the leads are plugged into the A (Amps) terminals.

To measure current:

1. Turn circuit power off.
2. Break the circuit
3. Insert the Meter in series with the circuit, and then turn circuit power on.

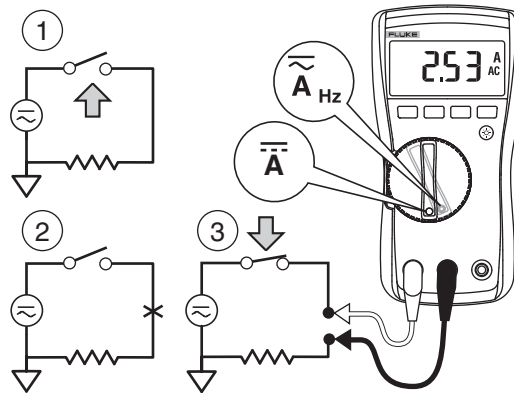

Measuring Current above 10 Amps (110, 114, 115, 117)

The millivolt and voltage function of the Meter can be used with an optional mV/A output Current Probe to measure currents that exceed the rating of the Meter. Make sure the Meter has the correct function selected, AC or DC, for your current probe. Refer to a Fluke catalog or contact your local Fluke representative for compatible current clamps.

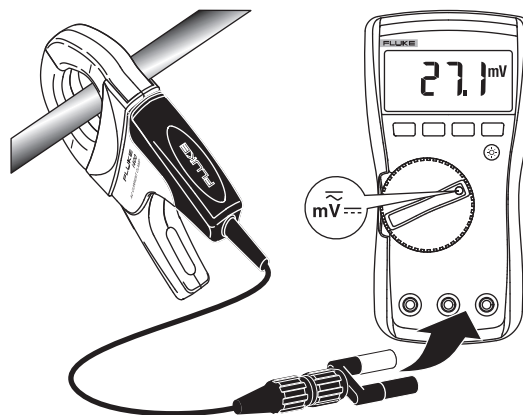

Measuring Capacitance (113, 115, 117)

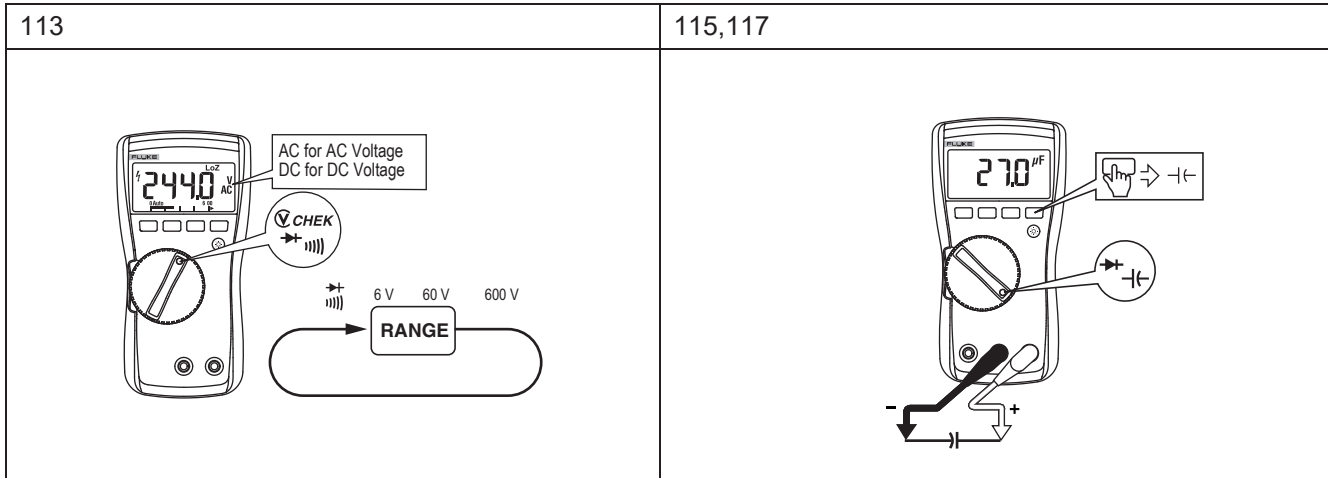

Measuring Frequency (115, 117)

⚠️ Warning

To avoid electrical shock, disregard the bar graph for frequencies >1 kHz. If the frequency of the measured signal is >1 kHz, the bar graph and ⚡ are unspecified.

The Meter measures the frequency of a signal by counting the number of times the signal crosses a trigger level each second. The trigger level is 0 V, 0 A for all ranges.

Press to turn on or turn off the frequency measurement function on and off. Frequency works with ac functions only.

In frequency, the bar graph and range annunciator indicate the ac voltage or current present.

Select progressively lower ranges using manual ranging for a stable reading.

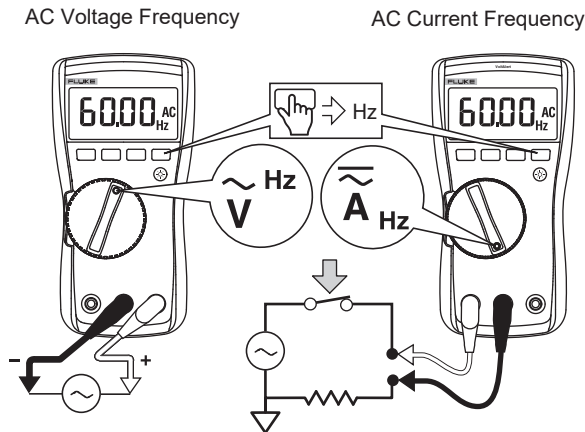

Detecting AC Voltage Presence (117)

To detect the presence of ac voltage, place the top of the Meter close to a conductor. The Meter gives an audible as well as visual indication when voltage is detected. The sensitivity settings are:

- Lo: use on flush mounted wall sockets, power strips, flush mounted industrial outlets and various power cords.
- Hi: for ac voltage detection on other styles of recessed power connectors or sockets where the actual ac voltage is recessed within the connector itself.

The VoltAlert detector works in bare wire applications with voltages as low as 24 V in the Hi setting.

⚠⚠ Warning

If there is no indication, voltage could still be present. Do not rely on the VoltAlert detector with shielded wire. Operation may be effected by differences in socket design, insulation thickness and type.

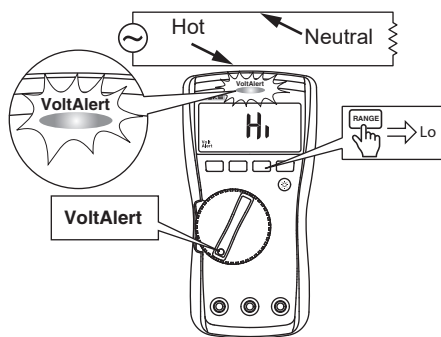

Making Low Impedance Capacitance Measurements (115, 117)

For making capacitance measurements on cables with ghost voltage:

1. Hold **RANGE** as you turn on the Meter to enable the low-input impedance Capacitance mode.
2. Wait until **LCAP** shows on the display.

In this mode, capacitance measurements will have a lower accuracy and lower dynamic range.

Note

This setting is not saved when the Meter is turned off or goes into sleep mode.

Testing Diodes (113, 115, 117)

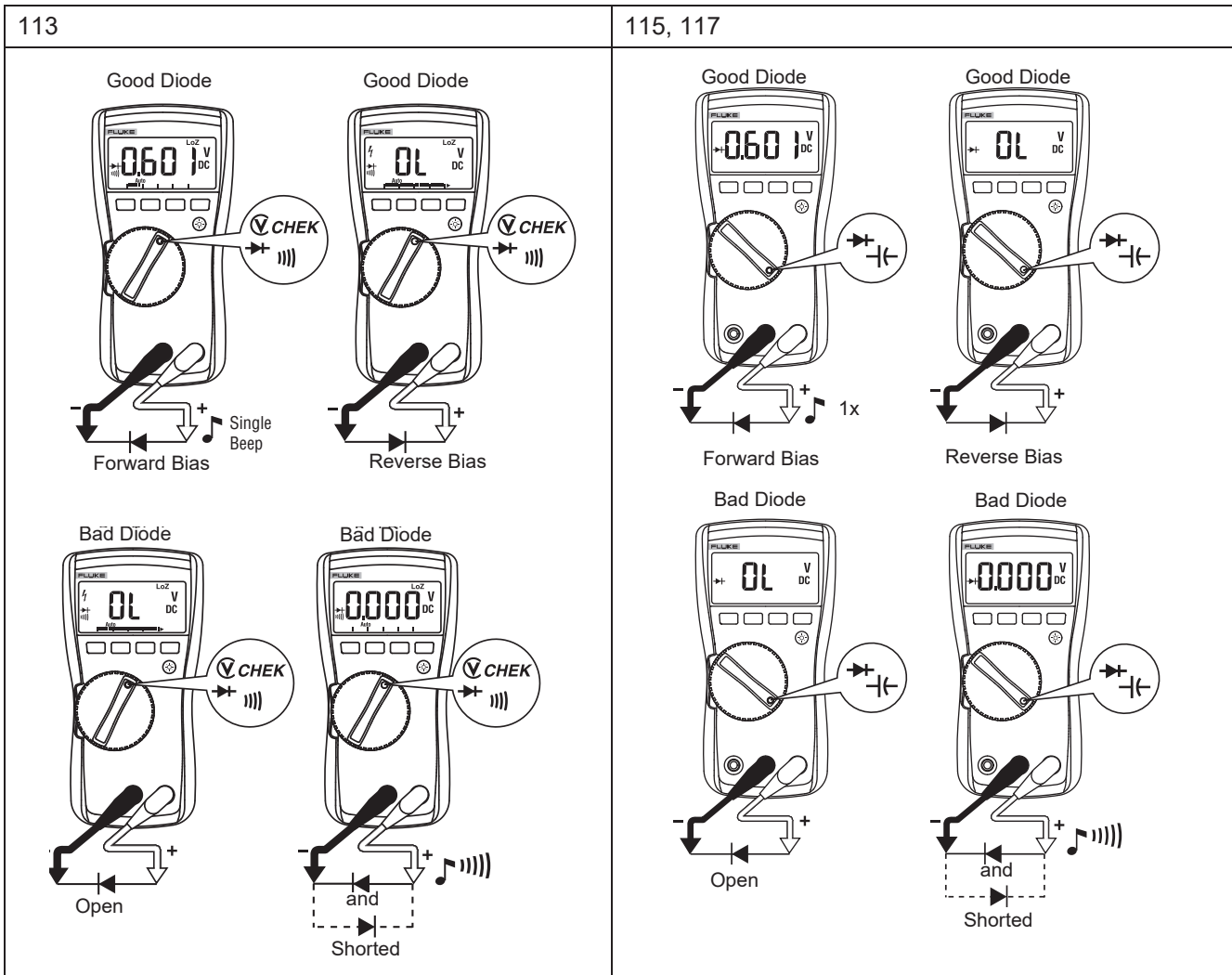

Using the Bargraph

The bar graph is like the needle on an analog meter. It has an overload indicator (▶) to the right and a polarity indicator (⊕) to the left.

Because the bar graph is much faster than the digital display, the bar graph is useful for making peak and null adjustments.

The bar graph is disabled when measuring capacitance. In frequency, the bar graph and range annunciator indicates the underlying voltage or current up to 1 kHz.

The number of segments indicates the measured value and is relative to the full-scale value of the selected range.

In the 60 V range, for example (see below), the major divisions on the scale represent 0, 15, 30, 45, and 60 V. An input of -30 V turns on the negative sign and the segments up to the middle of the scale.

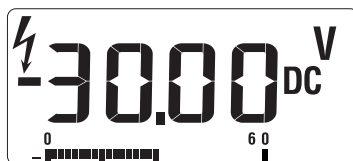

Maintenance

Maintenance of the Meter consists of battery and fuse replacement, as well as case cleaning.

Testing the Fuse (115, 117)

Test fuse as shown in Figure 1.

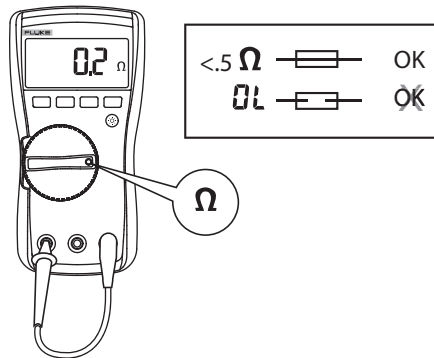

Figure 1. Test the Fuse

Replacing the Battery and Fuse

Warning

To avoid shock, injury, or damage to the Meter:

- Remove test leads from the Meter before opening the case or battery door.
- Use **ONLY** a fuse with the amperage, interrupt voltage, and speed ratings specified.

See Figure 2 for disassembly.

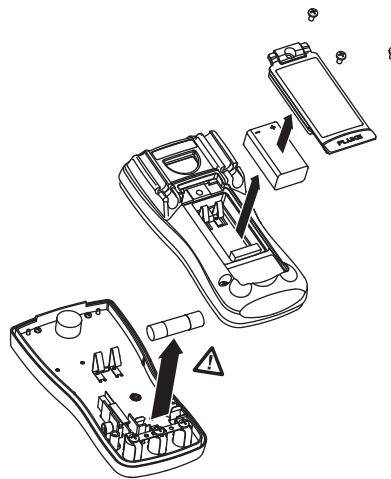

Figure 2. Disassembly

To remove the battery door for battery replacement:

1. Remove the test leads from the Meter.
2. Remove the battery door screw.
3. Use the finger recess to lift the door slightly.
4. Lift the door straight up to separate it from the case.
5. The battery fits inside the battery door, which is then inserted into the case, bottom edge first, until it is fully seated. Do not attempt to install the battery directly into the case.
6. Install and tighten battery door screw.

To open the case for fuse replacement:

1. Remove the test leads from the Meter.
2. Remove the Meter from its holster.
3. Remove two screws from the case bottom.
4. Separate the case bottom from the case top.
5. Remove the fuse from its holder and replace it with an 11 A, 1000 V, FAST fuse having a minimum interrupt rating of 17,000 A. Use only Fluke PN 803293.
6. To re-assemble the Meter, first attach the case bottom to the case top, then install the two screws. Finally, insert the Meter into its holster.

Cleaning

Wipe the case with a damp cloth and mild detergent. Dirt or moisture in the terminals can affect readings.

Specifications

Accuracy is specified for 1 year after calibration, at operating temperatures of 18 °C to 28 °C, with relative humidity at 0 % to 90 %.
Extended specifications are available at www.Fluke.com.

Maximum voltage between any terminal and earth ground 600 V

⚠ Fuse for A input (115 & 117 only)..... 11 A, 1000 V, IR 17 kA

Display

Digital.....6000 counts, updates 4/s

Bar Graph 33 segments, updates 32/s

Temperature

Operating.....-10 °C to 50 °C

Storage-40 °C to 60 °C

Temperature Coefficient..... 0.1 x (specified accuracy)/°C (<18 °C or >28 °C)

Altitude

Operating.....2000 meters

Storage 10 000 meters

Relative Humidity..... 95 % to 30 °C, 75 % to 40 °C, 45 % to 50 °C

Battery..... IEC 6LR61

Battery Life

113.....Alkaline: 300 hours typical, without backlight

110, 114, 115, 117.....Alkaline: 400 hours typical, without backlight

Safety IEC 61010-1: Pollution Degree 2
IEC 61010-2-033

113..... Measurement CAT IV 600 V

110, 114..... Measurement CAT III 600 V

115, 117..... Measurement CAT III 600 V, 10 A

Ingress Protection IEC 60529: IP42 (non-operating)

Electromagnetic Compatibility (EMC)

International..... IEC 61326-1: Portable Electromagnetic Environment
CISPR 11: Group 1, Class A

Group 1: Equipment has intentionally generated and/or uses conductively-coupled radio frequency energy that is necessary for the internal function of the equipment itself.

Class A: Equipment is suitable for use in all establishments other than domestic and those directly connected to a low-voltage power supply network that supplies buildings used for domestic purposes. There may be potential difficulties in ensuring electromagnetic compatibility in other environments due to conducted and radiated disturbances.

Caution: This equipment is not intended for use in residential environments and may not provide adequate protection to radio reception in such environments.

Emissions that exceed the levels required by CISPR 11 can occur when the equipment is connected to a test object.

Korea (KCC) Class A Equipment (Industrial Broadcasting & Communication Equipment)

Class A: Equipment meets requirements for industrial electromagnetic wave equipment and the seller or user should take notice of it. This equipment is intended for use in business environments and not to be used in homes.

USA (FCC) 47 CFR 15 subpart B. This product is considered an exempt device per clause 15.103.

Table 6. Accuracy Specifications

Function	Range	Resolution	Accuracy ± ([% of Reading] + [Counts])		Model
DC Millivolts	600.0 mV	0.1 mV	0.5 % + 2		110, 114, 115, 117
DC Volts	6.000 V	0.001 V	0.5 % + 2		110, 114, 115, 117
	60.00 V	0.01 V			
	600.0 V	0.1 V			
			DC, 45 to 500 Hz	500 Hz to 1 kHz	
Auto-V LoZ ^[1] True-rms	600.0 V	0.1 V	2.0 % + 3	4.0 % + 3	114, 117
Ⓢ CHEK ^[4]	6.000 V	0.001 V	2.0 % + 3		113
	60.00 V	0.01 V			
	600.0 V	0.1 V			
			45 to 500 Hz	500 Hz to 1 kHz	
AC millivolts ^[1] True-rms	600.0 mV	0.1 mV	1.0 % + 3	2.0 % + 3	110, 114, 115, 117
AC Volts ^[1] True-rms	6.000 V	0.001 V	1.0 % + 3		110, 114, 115, 117
	60.00 V	0.01 V			
	600.0 V	0.1 V			
Continuity ^[5]	600 Ω	1 Ω	Beeper on <20 Ω, off >250 Ω. Detects opens or shorts of 500 μs or longer.		110, 114, 115, 117
	---	---			113
Ohms ^[5]	600.0 Ω	0.1 Ω	0.9 % + 2		110, 113, 114, 115, 117
	6.000 kΩ	0.001 kΩ	0.9 % + 1		
	60.00 kΩ	0.01 kΩ	0.9 % + 1		
	600.0 kΩ	0.1 kΩ	0.9 % + 1		110, 114, 115, 117
	6.000 MΩ	0.001 MΩ	0.9 % + 1		
	40.00 MΩ	0.01 MΩ	5.0 % + 2		
Diode Test ^[5]	2.000 V	0.001 V	0.9 % + 2		115, 117
			2.0 % + 3		113
Capacitance ^[5]	1000 nF	1 nF	1.9 % + 2		113, 115, 117
	10.00 μF	0.01 μF	1.9 % + 2		
	100.0 μF	0.1 μF	1.9 % + 2		
	9999 μF	1 μF	100 μF - 1000 μF: 1.9 % + 2 >1000 μF: 5 % + 20		
Lo-Z Capacitance (Power-up option)	1 nF to 500 μF		10 % + 2 typical		115, 117
AC Amps True-rms ^[1] (45 Hz to 500 Hz)	6.000 A	0.001 A	1.5 % + 3		115, 117
	10.00 A ^[3]	0.01 A			
DC Amps	6.000 A	0.001 A	1.0 % + 3		115, 117
	10.00 A ^[3]	0.01 A			

Table 6. Accuracy Specifications (cont.)

Function	Range	Resolution	Accuracy ± ([% of Reading] + [Counts])	Model
Hz (V or A input) ^[2]	99.99 Hz	0.01 Hz	0.1 % + 2	115, 117
	999.9 Hz	0.1 Hz		
	9.999 kHz	0.001 kHz		
	50.00 kHz	0.01 kHz		
	99.99 kHz	0.01 kHz		
Notes:				
[1] All ac ranges except Auto-V LoZ are specified from 1 % to 100 % of range. Auto-V LoZ is specified from 0.0 V. Because inputs below 1 % of range are not specified, it is normal for this and other true-rms meters to display non-zero readings when the test leads are disconnected from a circuit or are shorted together. For volts, crest factor of ≤3 at 4000 counts, decreasing linearly to 1.5 at full scale. For amps, crest factor of ≤3. AC volts is ac-coupled. Auto-V LoZ, AC mV, and AC amps are dc-coupled.				
[2] AC Volts Hz is ac-coupled and specified from 5 Hz to 99.99 kHz. Minimum input required above 50.00 kHz typically is >1.1 vac sine. Minimum input typical and not specified. AC Amps Hz is dc-coupled and specified from 45 Hz to 5 kHz.				
[3] Δ >10 A unspecified. Duty cycle: >10 A to 20 A, 30 seconds on, 10 minutes off.				
[4] 113 only: All \checkmark <i>CHEK</i> voltage ranges are specified from 60 counts to 100 % of range. Because inputs <60 counts are not specified, it is possible and normal for this and other true-rms meters to display non-zero readings when the test leads are disconnected from a circuit or are shorted together. Crest factor of ≤3 at 4000 counts, decreasing linearly to 1.5 at full scale.				
[5] 113 only: After measuring voltage, a wait time of 1 minute is required to maintain accuracy of ohms, capacitance, diode test, and continuity.				

Table 7. Input Characteristics (110, 114, 115, 117)

Function	Input Impedance (Nominal)	Common Mode Rejection Ratio (1 k Ω Unbalanced)		Normal Mode Rejection
Volts AC	>5 M Ω <100 pF	>60 dB at dc, 50 or 60 Hz	0.5 % + 2	- - -
Volts DC	>10 M Ω <100 pF	>100 dB at dc, 50 or 60 Hz	0.5 % + 2	- - -
Auto-V LoZ	~3 k Ω <500 pF	>60 dB at dc, 50 or 60 Hz		- - -
	Open Circuit Test Voltage	Full Scale Voltage		Short Circuit Current
Ohms	<2.7 V dc	to 6.0 M Ω	40 M Ω	<350 μ A
		<0.7 V dc	<0.9 V dc	
Diode Test	<2.7 V dc	2.000 V dc		<1.2 mA

Table 8. Input Characteristics (113)

Function	Input Impedance (Nominal)	Common Mode Rejection Ratio
☑ CHEK	~3 kΩ <300 pF	>60 dB at dc, 50 or 60 Hz
	Open Circuit Test Voltage	Full Scale Voltage
Ohms	<2.7 V dc	<0.7 V dc
Diode Test	<2.7 V dc	<2.000 V dc
	Short Circuit Current	
Ohms		<350 μA
Diode Test		<1.0 mA

MIN MAX Recording Accuracy and Response Time (113)

Specified accuracy of the measurement function ± 40 counts in ☑ CHEK for changes >500 ms in duration, ± 12 counts in Ω for changes >325 ms in duration. Typical 100 ms response to 80 %. Response time not specified for capacitance.

DETAILED SPECIFICATIONS

Fluke 114, 115, 116 and 117 Digital Multimeters

Accuracy is specified for 1 year after calibration, at operating temperatures of 18 °C to 28 °C, with relative humidity of 0 % to 90 %.

General specifications	
Maximum voltage (between any terminal and earth ground)	600 V rms
Safety	IEC 61010-1, Pollution Degree 2 IEC 61010-2-033 CAT III 600 V, 10 A EMC IEC 61326-1: Portable
Fuse for A input (115, 117 only)	11 A, 1000 V, IR 17 kA (Fluke PN 803293)
Display	Digital: 6,000 counts, updates 4/sec; Bar Graph: 33 segments, updates 32/sec
Temperature	
Operating	-10 °C to +50 °C
Storage	-40 °C to +60 °C
Humidity	0 % to 90 % to 35 °C; 75 % to 40 °C; 45 % to 50 °C
Temperature coefficient	0.1 x (specified accuracy/°C) (< 18 °C or > 28 °C)
Operating altitude	2,000 meters
Battery	9 Volt Alkaline (IEC 6LR61)
Battery life	400 hours typical, without backlight
Certifications	CE, CSA, RCM
IP rating (dust and water protection)	IP42

Accuracy specifications (all models)					
Function	Range	Resolution	Accuracy ± ([% of Reading]+ [Counts])		Model
DC millivolts	600.0 mV	0.1 mV	0.5 % + 2		114, 115, 116, 117
DC volts	6.000 V	0.001 V	0.5 % + 2		114, 115, 116, 117
	60.00 V	0.01 V			
	600.0 V	0.1 V			
Auto-V LoZ ¹ true-rms (114, 116, 117 only)	600.0 V	0.1 V	DC, 45 Hz to 500 Hz	500 Hz to 1 kHz	114, 116, 117
			2.0 % + 3	4.0 % + 3	
AC millivolts ¹ true-rms	600.0 V	0.1 V	45 Hz to 500 Hz	500 Hz to 1 kHz	114, 115, 116, 117
			1.0 % + 3	2.0 % + 3	
AC volts ¹ true-rms	6.000 V 60.00 V 600.0 V	0.001 V 0.01 V 0.1 V	1.0 % + 3	2.0 % + 3	114, 115, 116, 117
Continuity (115, 116 only)	600 Ω	1 Ω	Beeper on < 20 Ω, off > 250 Ω; detects opens or shorts of 500 μs or longer		114, 115, 116, 117
Ohms	600.0 Ω	0.1 Ω	0.9 % + 2		114, 115, 116, 117
	6.000 kΩ	0.001 kΩ	0.9 % + 1		
	60.00 kΩ	0.01 kΩ	0.9 % + 1		
	600.0 kΩ	0.1 kΩ	0.9 % + 1		
	6.000 MΩ	0.001 MΩ	0.9 % + 1		
	40.00 MΩ	0.01 MΩ	5.0 % + 2		
Diode test	2.000 V	0.001 V	0.9 % + 2		115, 116, 117
Capacitance (115, 116, 117 only)	1000 nF	1 nF	1.9 % + 2		115, 116, 117
	10.00 μF	0.01 μF	1.9 % + 2		
	100.0 μF	0.1 μF	1.9 % + 2		
	9999 μF	1 μF	100 μF to 1000 μF: 1.9 % + 2		
	-	-	> 1000 μF: 5 % + 20		

¹ All ac ranges except Auto-V LoZ are specified from 1 % to 100 % of range. Auto-V LoZ is specified from 0.0 V. Because inputs below 1 % of range are not specified, it is normal for this and other true-rms meters to display non-zero readings when the test leads are disconnected from a circuit or are shorted together. For volts, crest factor of ≤ 3 at 4000 counts, decreasing linearly to 1.5 at full scale. For amps, crest factor of ≤ 3. AC volts is ac-coupled. Auto-V LoZ, ac mV, and ac amps are dc-coupled.

Accuracy specifications (all models)

Function	Range	Resolution	Accuracy ± ([% of Reading]+ [Counts])	Model
LoZ capacitance (power-up option) (114, 116, 117 only)	1 nF to 500 µF		10 % + 2 typical	115, 116, 117
Temperature - K-Type thermocouple (116 only)	-40 °C to 400 °C -40 °F to 752 °F	0.1 °C 0.2 °F	1 % + 10 ² 1 % + 18 ²	116
AC amps true-rms ¹ (45 Hz to 500 Hz) (115, 117 only)	6.000 A 10.00 A 20 A overload for 30 seconds maximum	0.001 A 0.01 A	1.5 % + 3	115, 117
AC µAmps true-rms ¹ (45 Hz to 1 kHz) (116 only)	600.0 µA	0.1 µA	1.5 % + 3 (2.5 % + 3 > 500 Hz)	116
DC amps (115, 117 only)	6.000 A 10.00 A 20 A overload for 30 seconds maximum	0.001 A 0.01 A	1.0 % + 3	115, 117
DC µAmps true-rms (116 only)	600.0 µA	0.1 µA	1.0 % + 2	116
Hz (V or A input) ² (Hz A 115, 117 only)	99.99 Hz 999.9 Hz 9.999 kHz 50.00 kHz	0.01 Hz 0.1 Hz 0.001 kHz 0.01 kHz	0.1 % + 2	115, 117
Hz (V input) ³ (115, 116, 117 only)	99.99 Hz 999.9 Hz 9.999 kHz 50.00 kHz	0.01 Hz 0.1 Hz 0.001 kHz 0.01 kHz	0.1 % + 2	116

1 All ac ranges except Auto-V LoZ are specified from 1 % to 100 % of range. Auto-V LoZ is specified from 0.0 V. Because inputs below 1 % of range are not specified, it is normal for this and other true-rms meters to display non-zero readings when the test leads are disconnected from a circuit or are shorted together. For volts, crest factor of ≤ 3 at 4000 counts, decreasing linearly to 1.5 at full scale. For amps, crest factor of ≤ 3. AC volts is ac-coupled. Auto-V LoZ, ac mV, and ac amps are dc-coupled.

2 AC Volts Hz is ac-coupled and specified from 5 Hz to 50 kHz. AC Amps Hz is dc-coupled and specified from 45 Hz to 5 kHz. Amps input burden voltage (typical): 6 A input 2 mV/A, 10 A input 37 mV/A.

3 Frequency is ac-coupled, 45 Hz to 50 kHz.

Frequency counter sensitivity (models 115, 116, 117)

Input range		Typical sensitivity (rms sine wave)			
		5 Hz to 45 Hz	45 Hz to 5 kHz	5 kHz to 10 kHz	10 kHz to 50 kHz
Volts AC	V	0.2 V	0.2 V to 0.3 V	0.3 V to 0.4 V	0.4 V to 1.0 V
	60 V	2 V	2 V to 3 V	3 V to 4 V	4 V to 10 V
	600 V	20 V	20 V to 30 V	30 V to 40 V	40 V to 100 V
AC Amps (115, 117 only)	6 A	N/A	0.4 A	N/A	N/A
	10 A	N/A	0.5 A	N/A	N/A

Input characteristics (all models)

Function	Input impedance (nominal)	Common mode rejection ratio (1 kΩ unbalanced)		Normal mode rejection
Volts AC	> 5 MΩ < 100 pF	> 60 dB at dc, 50 or 60 Hz		
Volts DC	> 10 MΩ < 100 pF	> 100 dB at dc, 50 or 60 Hz		> 60 dB at 50 or 60 Hz
Auto-V LoZ (114, 116, 117 only)	~3 kΩ < 500 pF	> 60 dB at dc, 50 or 60 Hz		
	Open circuit test voltage	Full scale voltage		Short circuit current
Ohms	< 2.7 V dc	To 6.0 MΩ	40 MΩ	< 350 µA
		< 0.7 V dc	< 0.9 V dc	
Diode test (115, 117 only)	< 2.7 V dc	2.000 V dc		< 1.2 mA

Fluke. Keeping your world up and running.®

Fluke Corporation
PO Box 9090, Everett, WA 98206 U.S.A.

For more information call:
In the U.S.A. (800) 443-5853
In Canada (800) 36-FLUKE
From other countries +1 (425) 446-5500
www.fluke.com

©2006, 2020 Fluke Corporation.
Specifications subject to change without notice.
08/2020 2793260b-en

Modification of this document is not permitted without written permission from Fluke Corporation.